

Design Guidelines – Solar Space Heating of Factory Buildings With Underfloor Heating Systems

By Dagmar Jaehnig and Werner Weiss, AEE INTEC, Austria



Design Guidelines – Solar Space Heating of Factory Buildings With Underfloor Heating Systems

Dagmar Jaehnig • Werner Weiss

AEE INTEC
AEE - Institute for Sustainable Technologies
8200 Gleisdorf, Austria

This booklet was prepared as an account of work done within Task 33 “Solar Heat for Industrial Processes” of the IEA Solar Heating and Cooling Programme and Task IV of the IEA SolarPACES Programme.

Published by AEE INTEC, Gleisdorf, Feldgasse 19, Austria, 2007

with financial support of the Austrian Ministry for Transport, Innovation and Technology



© 2007 Solar Heating and Cooling Executive Committee of the International Energy Agency (IEA)

Notice: The Solar Heating and Cooling Programme functions within a framework created by the International Energy Agency (IEA). Views, findings and publications of the Solar Heating and Cooling Programme do not necessarily represent the views or policies of the IEA Secretariat or of all its individual member countries.

Table of Contents

Summary	2
1 Introduction	3
2 Factory Buildings	3
2.1 Space Heating Systems for Factory Buildings	3
2.2 Underfloor Heating Systems	4
2.3 Heat Demand of Factory Buildings	5
2.4 Reference Building	5
3 System Concepts	8
4 Dimensioning	10
4.1 Collector Tilt Angle	11
4.2 System Concept with Storage Tank	11
4.3 Concrete Floor Slab as Heat Store	16
5 Conclusions	19
6 Appendix 1 – Description of the IEA Solar Heating and Cooling Programme	20
7 Appendix 2 – Description of Task 33/IV Solar Heat for Industrial Processes	22

Summary

This booklet presents a method to design solar thermal systems for space heating of factory buildings using underfloor heating systems. The method uses nomograms that were expanded upon using simulations of typical system configurations. There are nomograms for two different system configurations that can be used to determine reasonable values for the collector and storage tank size for a factory building with a known heat demand. An example of such a nomogram is shown in the figure below.

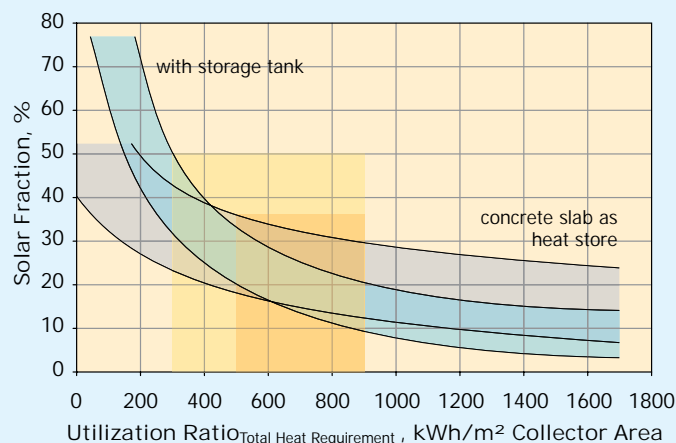

Nomograms are useful because they help to decide whether it is necessary to use a water filled storage tank or if it makes sense to use the thermal mass of the concrete floor slab as heat storage. The advantage of using the concrete floor slab is that the costs for a (often times large) storage tank can be saved.

Further aspects covered in this report are the necessity of an insulation layer underneath the floor slab, reasonable orientation of the collectors and specific collector yields that can be achieved with the different system configurations.

1 Introduction

The energy required for the space heating of factory buildings and warehouses can be a major percentage of the energy consumption of a company. While in some cases, waste heat from other processes in the company is available and is the most cost effective way to heat a factory building, an interesting option is to use solar energy to cover the heat demand of an industrial building.

Factory buildings and warehouses differ from residential or office buildings in several ways. Room heights are 5 - 10 m and the required room temperatures are as low as 15 - 18°C. Low required room temperatures in combination with simple system concepts that can be used for space heating of factory buildings are an ideal situation for the application of solar thermal energy. These factors create a big potential for the use of solar thermal energy in the industry.

2 Factory Buildings

2.1 Space Heating Systems for Factory Buildings

There are a multitude of heating systems for factory buildings on the market. Some of them are directly fired systems (in most cases with natural gas) that are not suitable for the integration of solar energy.

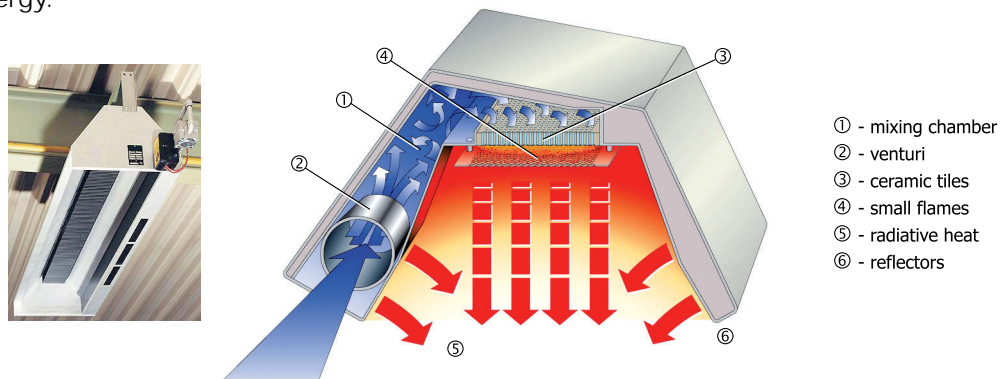

Fig. 1

Gas-fired infrared heaters (www.asue.de and www.schwank.de).

Others are indirectly heated systems supplied with hot water from a fossil fuel or biomass boiler. There are, for example, radiant ceiling panels or fan-coil systems available. The disadvantage of these systems is that they need relatively high temperatures (typical values range from 50 - 70°C, in some cases temperatures are even higher).

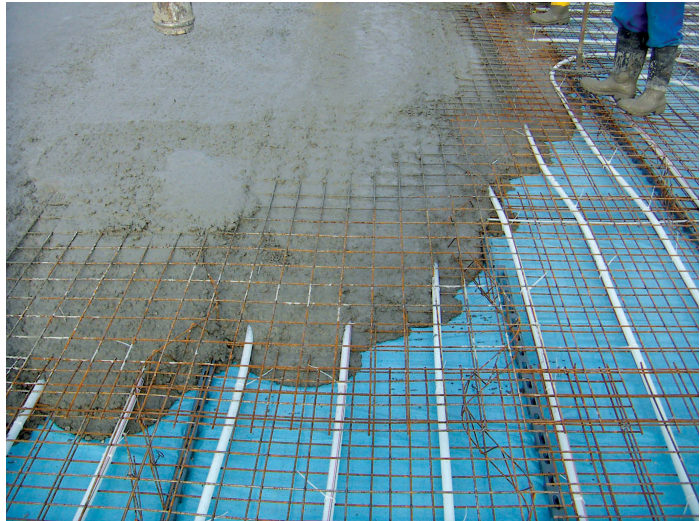

Fig. 2

Indirectly heated radiant ceiling panel (www.kampmann.de) and fan-coil system (www.remko.de).

Another space heating option is underfloor heating systems, which are becoming increasingly popular for industrial buildings. These systems are a perfect match for solar energy because the system's flow temperature is particularly low so as soon as the solar thermal collector delivers a temperature above the air temperature in the building it can supply heat.

Fig. 3 *Industrial underfloor heat distribution system. (Source: SOLution, Austria)*



2.2 Underfloor Heating Systems

Underfloor heating systems can be incorporated within industrial floors and also within load bearing structural floors in a variety of different ways. Many manufacturers of underfloor heating systems offer solutions not only for residential but also for different types of industrial applications.

The pipes of an underfloor heating system can be installed at different depths. If machines or other equipment have to be mounted onto the floor with bolts, it may be necessary to install the pipes lower in the concrete to avoid damage to the pipes. A general rule is that the heating system is slower to respond the deeper the piping is installed in the concrete.

Fig. 4 *Underfloor heating systems are used to heat maintenance hangars. (Source: Velta/Uponor)*



Figure 6 shows how the air and the floor temperatures react in a system with 60 cm of concrete floor but with piping installed at 10, 30 and 50 cm depths respectively. The system is controlled so that the heating system is turned on as soon as the air temperature in the factory building goes below 16°C. The system with the pipes at 10 cm is the fastest to react. The temperature of the floor surface goes up immediately and also the air temperature starts to increase very soon after the heating system is turned on. The other two systems are much slower to respond. It takes some time for the floor temperature to go up (especially at the 50 cm depth). And the air temperature goes well below the set temperature of 16°C.

An adequate control strategy for systems where the piping has to be installed at a greater depth starts the heating system somewhat earlier. This can prevent the building from going too far below the set temperature.

Fig. 5 *Structural Floor System. Here: A possible solution for mounting pipes of an underfloor heating system to the re-enforcing bars in a concrete floor. (Source: Warmafloor, UK)*

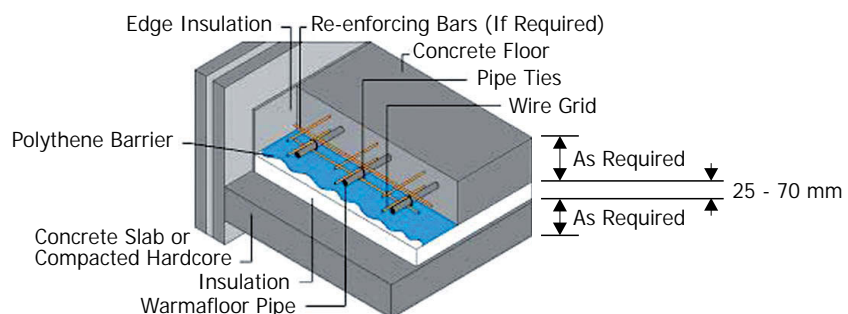

Fig. 6 Influence of depth of piping in an underfloor heating system.

2.3 Heat Demand of Factory Buildings

The energy demand for space heating of industrial buildings is not only influenced by the level of insulation and the geometry (compactness) of the building, but also by its use. Internal gains and infiltration and ventilation losses vary greatly depending on the usage of the building and influence strongly the space heating demand of an industrial building. Most industrial buildings consist of a relatively heavy concrete floor and lightweight construction for the walls and roof. Often, both the walls and roof consist of two layers of sheet metal with an insulation layer in between. The metal layers may be profiled or corrugated sheet metal. Factory-made wall and roof elements, so-called sandwich panels, are available on the market. The thermal mass of these is very low.

It is very important to know as accurately as possible the heat demand of the building for dimensioning the solar thermal system to heat the industrial building. To show the influence of different factors on the heat demand of a factory building four reference cases for Austrian climatic conditions have been defined.

Austrian climatic conditions represent a large part of central Europe where space heating of industrial buildings is necessary. Even if a local climate differs somewhat from the data used for the simulations in this study, the derived nomograms are still valid for rough dimensioning of a system. All simulations for the design guidelines presented in this booklet were carried out in the TRNSYS simulation environment.

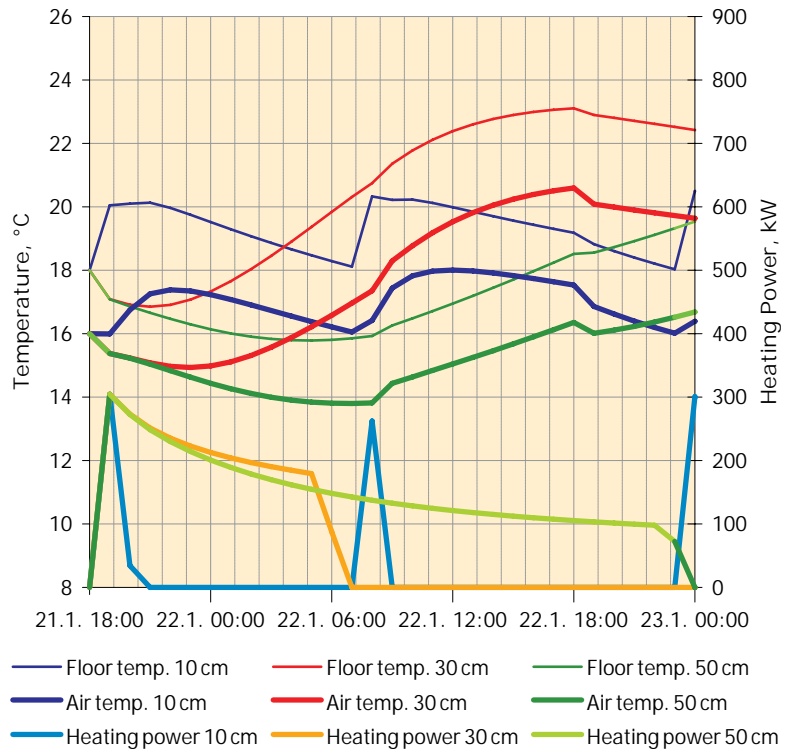

2.4 Reference Buildings

The reference building has a floor area of 1000 m² (height: 6 m). It is facing south and has a flat roof. At this south façade, solar thermal collectors could be integrated (see Figure 7).

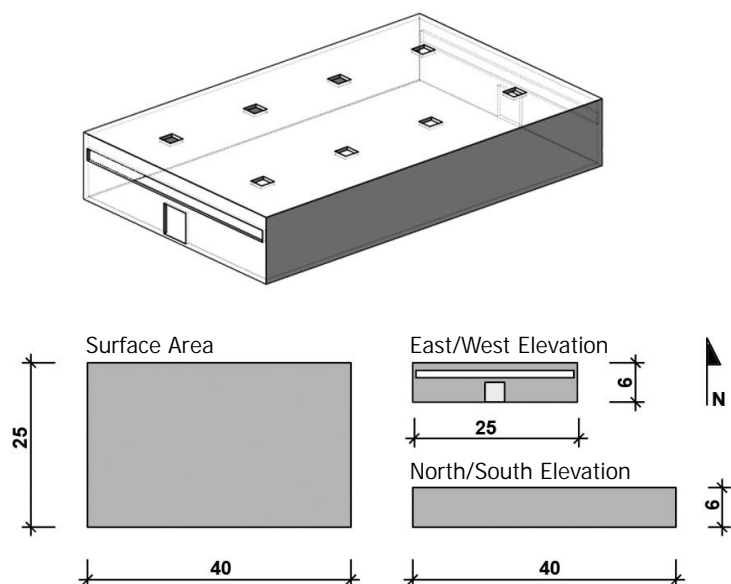

Fig. 7 Dimensions of the reference building.

Four different reference cases were defined corresponding to typical insulation and usage scenarios for industrial buildings. The corresponding building parameters can be found in Table 1.

		Case 1	Case 2	Case 3	Case 4
		Poorly insulated, high air exchange rate	Poorly insulated	Standard	High internal gains
Building construction					
U-Value Walls	W/(m ² K)	0.584	0.584	0.233	0.233
U-Value Roof	W/(m ² K)	0.350	0.350	0.184	0.184
U-value Floor	W/(m ² K)	0.307 - 0.364	0.307 - 0.364	0.307 - 0.364	0.307 - 0.364
Area (Windows and Doors)	m ²	88	88	88	88
g-value Windows	-	0.589	0.589	0.589	0.589
U-value Windows	W/(m ² K)	1.4	1.4	1.4	1.4
Internal Gains					
People (8 - 18 h), M - F	-	15	15	15	15
Light	W/m ²	5	5	5	5
Machine Operation (8 - 18 h), M - F	kW	0	0	0	8
Air Exchange Rate	h ⁻¹	0.6	0.3	0.3	0.3

Tab. 1

Building parameters of the reference building.

The so-called "Standard" reference building (Case 3) in the table is a relatively well insulated building with wall sections consisting of 160 mm of mineral wool insulation and 2 mm of sheet metal on both sides. This corresponds to quite low u-values of 0.23 W/(m² K) for the walls and 0.18 W/(m² K) for the roof where 200 mm of mineral wool insulation was assumed. The windows are standard double-glazed insulating windows. However, in retrofit situations, industrial buildings are often not very well insulated (sometimes not insulated at all). To show the influence of the insulation level, a poorly insulated reference building was also defined with only 60 mm of mineral wool insulation in the walls and 100 mm in the roof (Cases 1 and 2).

The air exchange rate in industrial buildings is especially difficult to estimate. It varies strongly depending on the number and duration of door openings. For this study, a standard air exchange rate of 0.3 h⁻¹ was assumed. For the case with increased air exchange rate (Case 1) a value of 0.6 h⁻¹ was used.

For the internal loads, a one-shift operation with 15 people working in the building and 5 W/m² lighting was assumed for all the cases. To show the influence of machine operation inside the building with considerable waste heat, another case with 8 kW of waste heat during working hours (8 - 18 h) was considered (Case 4). The value of 8 kW was chosen so that there is still a heat demand left for the building (mainly at night). If there is more waste heat inside the building, this waste heat is sufficient to heat the building. In this case, it would not make sense to use solar energy for space heating.

Figure 8 shows the space heating demand of the 4 studied cases. The standard reference building has a space heating demand of approximately 70 kWh/(m² a). When the insulation level is reduced the space heating demand goes up to 105 kWh/(m² a), Case 2. And, an additional increase of the air exchange rate leads to a space heating demand of more than 150 kWh/(m² a), Case 1. The

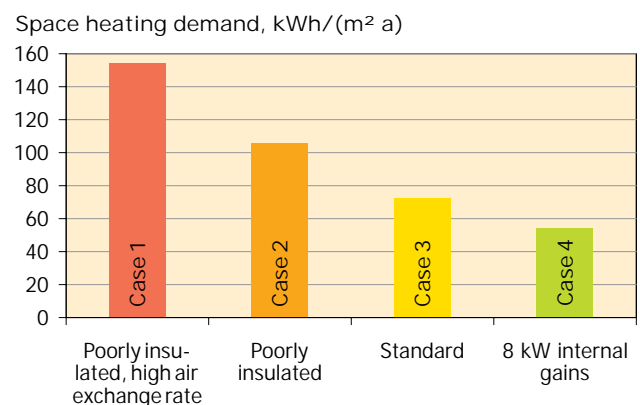

Fig. 8

Space heating demand of reference buildings.

machine operation inside the building with a waste heat of 8 kW reduces the space heating demand to roughly 50 kWh/(m² a), Case 4. These cases were created to take into account a large range of scenarios.

2.4.1 Insulation Layer Underneath the Floor Slab

All cases shown above were calculated with an insulation layer of 10 cm underneath the floor slab. However, industrial buildings are often constructed without an insulation layer underneath the floor. The concrete floor is put directly on some kind of gravel to prevent the concrete floor from frost damage. In buildings that have a relatively low indoor air temperature and where the concrete slab is not heated, the temperature at the bottom side of the slab is low. The temperature difference between the bottom of the floor slab and the soil underneath a large building is also low. Therefore, not insulating the floor slab may in these cases be justified. However, a perimeter insulation around the building is useful in order to prevent the edges of the floor slab from freezing.

Having said that, temperatures underneath the concrete slab are considerably higher if an under-floor heating system is installed in the concrete. Of course, this depends on the used flow temperatures. But in any case, the temperature difference between the bottom of the concrete and the soil underneath is much higher than without an underfloor heating system. Therefore, the heat losses will be much higher, too.

How much energy is lost through the floor slab of such a building depends on the physical parameters of the soil underneath. To illustrate the influence of an insulation layer underneath the floor slab and to show the influence of the soil characteristics, simulations were carried out with two extreme sets of soil parameters: very light and dry soil such as sand that doesn't conduct the heat well and heavy wet soil such as clay that is much more dense and conducts heat well (see Table 2). Interestingly enough the heat capacities per unit mass of very heavy and very light soil are very similar. Obviously, they are very different per unit volume because of the different densities, but for this study identical values have been used for the heat capacity per unit mass (see Table 2).

Tab. 2 *Comparison of parameters of heavy and wet soil and light and dry soil.*

	Soil Parameters		
	Conductivity	Density	Heat Capacity
	λ	ρ	c
	W / (m K)	kg / m ³	J / (kg K)
Heavy soil (wet)	2.42	3,200	840
Light soil (dry)	0.35	1,442	840

The calculations were carried out using the standard reference building described above, with and without the insulation layer underneath, and with the two different sets of earth parameters. The results are shown in Figure 9.

As expected, the influence of the soil parameters on the heat demand of the building is much larger if there is no insulation layer underneath the building. However, the most important result is that the space heating demand is roughly doubled without an insulation layer underneath the building. For the simulation of the reference cases, average soil parameters were used.

Fig. 9 *Space heating demand with and without underfloor insulation and for different soil parameters.*

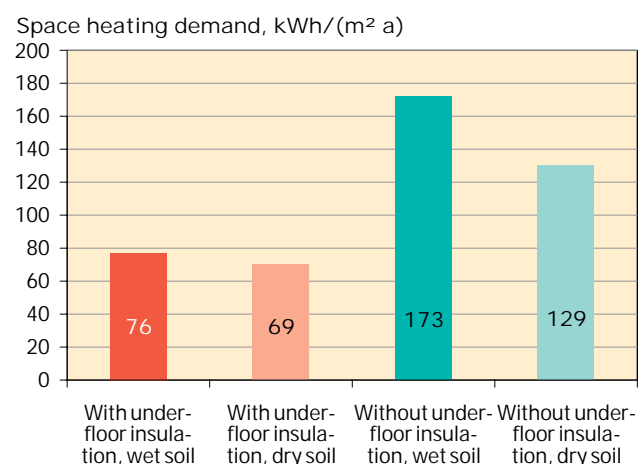

Additional simulations were carried out to investigate whether an extended perimeter insulation (1 - 2 m deep) would reduce the heat demand of the building significantly. For the reference buildings, this reduced the heat demand only a few percentage points. Furthermore, simulations were carried out for five years to determine if continuous heating of the soil underneath the building would increase the average soil temperature and thereby reduce the heat demand of the building significantly. Again, the reduction in heat demand was relatively low (approximately 5% after 5 years) and therefore doesn't justify omitting the insulation layer underneath the building.

System Concepts

In most solar space heating systems applied in factory buildings, the standard system concepts have been used — collectors heat a standard storage tank that feeds into an underfloor heating system (see Figure 10). This option makes sense,

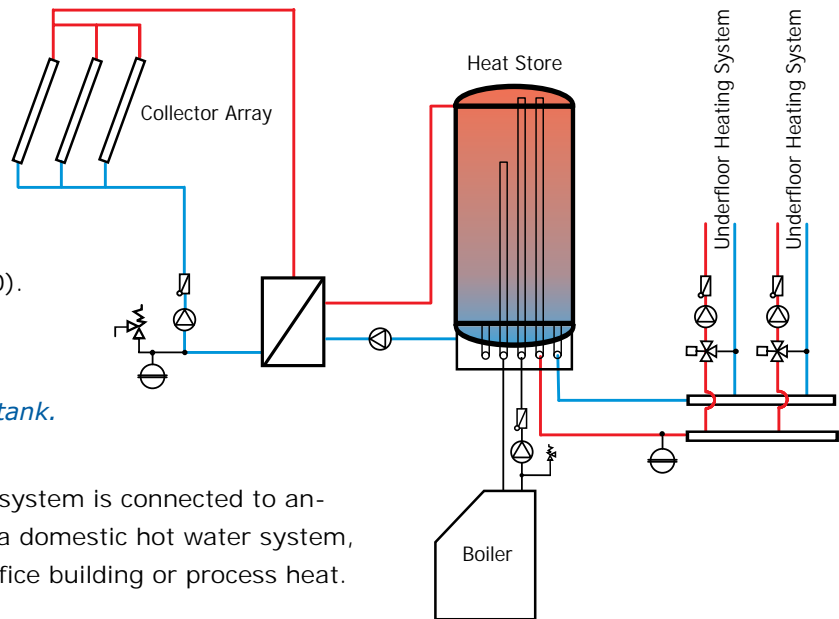

Fig. 10 System concept with storage tank.

especially if the solar heating system is connected to another heat consumer such as a domestic hot water system, space heating system in an office building or process heat.

Built Example:	Neudorfer
Location:	Rutzenmoos, Austria
Size of building:	400 m ² , height: 5 m
Usage:	warehouse, offices
Year of construction:	2005
Collector type:	flat-plate collectors
Collector size:	68 kW _{th} (97 m ²), on the roof
Heat distribution system:	underfloor heating system
Auxiliary heating:	heat pump (134 kW)
Storage:	1000 l storage tank



This warehouse with an integrated office building is an HVAC installation firm in Austria. It has solar thermal collectors installed on the roof for space heating the warehouse and offices and façade-integrated photovoltaic panels for electricity. The section of the building containing the offices is built according to the 'Passivhaus' standard with an annual space heating consumption of 18 kWh/(m² a). The warehouse is equipped with an underfloor heating system.

Built Example:	VMZ
Location:	Ludesch, Austria
Size of building:	1500 m ² , height: 6 m
Usage:	factory building, warehouse, offices
Year of construction:	2000
Collector type:	flat-plate collectors
Collector size:	63 kW _{th} (90 m ²), on the roof
Heat distribution system:	underfloor heating system
Auxiliary heating:	district heating (distribution using fan coil units in the warehouse)
Storage:	1000 l storage tank

The solar thermal collectors that heat the factory building and warehouse of this metal working industry is integrated in the glass façade of the attached office building. The alternating collector and window panels form an aesthetically pleasing entrance area for visitors while highlighting the high-tech image of the company.



Fig. 11

Hydraulic layout without storage tank, the concrete slab is used to store solar heat.

Another option would be to use the thermal mass of the concrete floor of the building, which has a large storage capacity, to replace the storage tank entirely. This is possible because most industrial buildings have a relatively thick concrete floor and the required room temperatures are typically lower than in residential buildings.

An additional step to simplify the system would be to abandon the heat exchanger between the collector array and the underfloor heating system and to fill the entire system with antifreeze fluid.

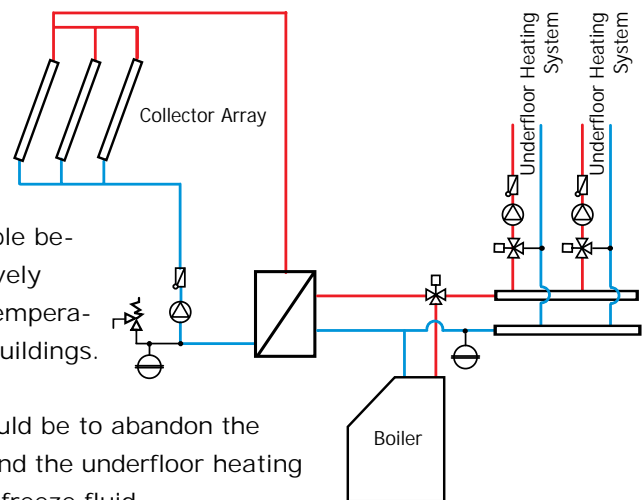
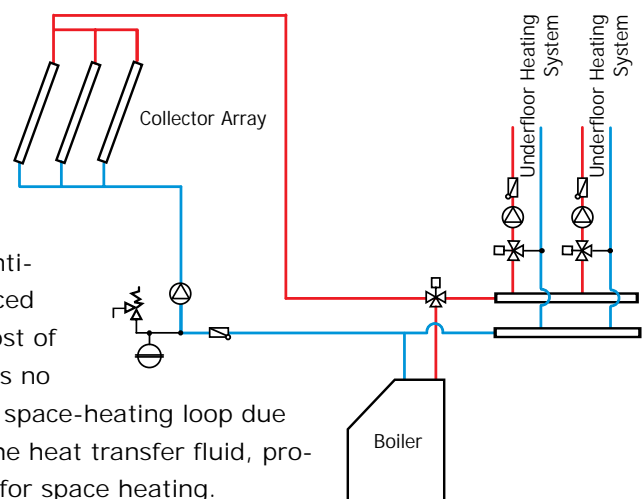

Fig. 12

Hydraulic layout with direct charging of floor slab from solar collectors (without heat exchanger).

The disadvantage of this concept is that a large quantity of anti-freeze fluid is needed depending on the size of the building. The anti-freeze fluid is expensive and has to be replaced from time to time. On the other hand, the cost of the heat exchanger can be saved and there is no loss in temperature from the collector to the space-heating loop due to the heat exchanger. The temperature of the heat transfer fluid, provided by the collectors, can be used directly for space heating.



Built Example:	Winkler Solarsysteme
Location:	Feldkirch, Austria
Size of building:	550 m ² , height: 7 m
Usage:	factory building, warehouse
Year of construction:	2000
Collector type:	flat-plate collectors
Collector size:	90 kW _{th} (129 m ²), partly façade integrated, partly on the roof
Heat distribution system:	underfloor heating system
Auxiliary heating:	none
Storage:	concrete floor slab



This factory building by the Austrian manufacturer of solar thermal collectors Winkler Solarsysteme GmbH has no auxiliary heating system and no conventional storage tank. The thermal mass of the concrete floor slab is used as heat storage. The example shows that it is possible to heat a factory building entirely by solar energy if the air temperature in the building is allowed to go a few degrees below the set temperature of 16°C on a few days of the year. The lowest recorded temperature inside the building was 12°C.

If the concrete floor is used to store heat, it should be charged whenever there is heat available from the collectors even if the room temperature is already reached. This way, the storage capacity of the floor can be best used. Of course, both room temperature and floor temperature should not pass certain specified limits. The European standard EN 1264 states maximum floor surface temperatures of 29°C in the central part of the floor surface and 35°C in the peripheral zone. These temperatures are determined by physiological considerations.

4. Dimensioning

In this section, guidelines for the dimensioning of solar heating systems in factory buildings are provided. The guidelines are based on simulations of the reference buildings described above with different heating system concepts and system sizes. The main boundary conditions for these simulations are described in the box below.

Data of Graz, Austria		Jan	Feb	Mar	Apr	May	Jun	Jul	Aug	Sep	Oct	Nov	Dec	TOTAL
Global radiation on horizontal	kWh/m ²	38	50	91	117	146	153	166	144	101	69	39	30	1,143
Global radiation 90° south	kWh/m ²	69	69	92	81	78	75	84	89	88	87	67	60	939
Ambient temperature	°C	-3.4	-0.6	4.0	8.8	13.7	16.8	18.8	18.1	14.1	8.9	2.7	-1.7	8.4

Façade-integrated collectors, south-oriented

Flat plate collector [$\eta_o = 0.8$, $c_1 = 3.5 \text{ W}/(\text{m}^2\text{K})$, $c_2 = 0.015 \text{ W}/(\text{m}^2 \text{K}^2)$]

Set air temperature of the building 16°C (24 hours per day)

Flow temperature underfloor heating system:

- Auxiliary heated or via storage tank: 35°C
- Directly from solar: up to 70°C

Control strategy:

- Underfloor heating system turns on when the air temperature goes below 16°C and turns off when 16.5°C is reached.
- For solar charging of concrete slab: When collector temperature is above the floor temperature, the system is turned on. System is turned off if the collector temperature is too low or if the surface temperature of the concrete reaches 23°C.

The most important result of the simulations is the solar fraction that is reached with the certain building and system configuration. The solar fraction is defined as

$$\text{Solar Fraction} = 1 - \frac{Q_{aux}}{Q_{conf}}$$

where Q_{aux} Energy delivered by the auxiliary heating system, kWh/a

Q_{conv} Energy needed for space heating without the solar thermal system, kWh/a

4.1 Collector Tilt Angle

Figure 13 shows the influence of the collector tilt angle on the solar fraction for Austrian weather data. The optimum collector tilt angle for space-heating-only applications (no domestic hot water demand) is around 60°.

In industrial space heating applications, there is often very little heat demand during the summer months. Therefore, façade integration of the collectors is a good solution. Deviation from the optimum tilt angle to a façade-integrated system (90° tilt angle) only leads to a reduction of the solar fraction by approximately 15%. This reduction can easily be compensated by choosing a bigger collector area. The shaded area in the figure shows the range of collector tilt angles that is recommended to use for space heating applications. Of course, care has to be taken to avoid shading of the collectors by nearby buildings for example.

Fig. 13 *Relative solar fraction as a function of the collector tilt angle.*

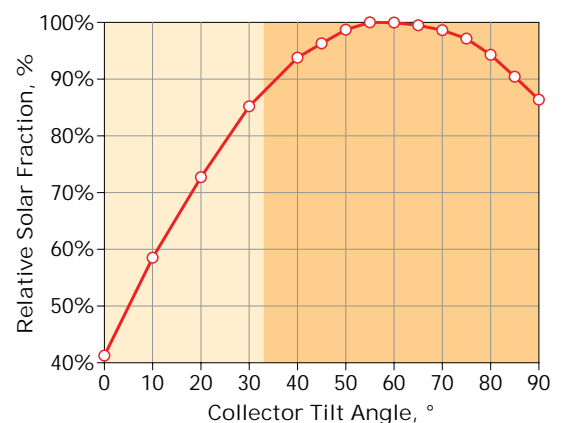

Installing the collector in the façade instead of on the roof at the optimum tilt angle has several advantages:

- Solar radiation on the collectors is reduced during the summer period when there is little or no heat demand. This simplifies the measures that have to be taken to avoid problems during stagnation.
- Collectors integrated into the façade of an industrial building can substitute regular façade elements and therefore reduce costs. The insulation of the collector can serve at the same time as the insulation of the building.
- Collector can be integrated into an attached office building and can replace large glass facades that would otherwise lead to high cooling loads in the building.
- Installing the collectors in the façade make them more visible and can be used to show an innovative and environmentally friendly image of a company. Many companies have installed the collectors in the façade of an office wing to exhibit the high-tech character of the company to visitors (see example VMZ on page 9).

4.2 System Concept with Storage Tank

In this section, guidelines are given for the dimensioning of systems according to the standard system concept (Figure 10) that uses a storage tank and an underfloor heating system.

With this system concept, the collector area and the solar storage tank volume display the greatest sensitivity with respect to the solar fraction and the level of the capital costs. For this reason, the first step will be to determine these parameters.

For the reference cases defined on pages 5 - 7, the solar fraction that is reached with different system sizes, was calculated based on numerous simulation calculations in the TRNSYS simulation environment.

Fig. 14 *Solar fraction reached with different system sizes (specific solar storage tank volume 50 l/m² collector area).*

For all cases shown in Figure 14, a specific solar storage tank volume of 50 liter per m² of collector area was used (This number does not include additional tank volume necessary to reduce cycling of an auxiliary boiler). The figure shows solar fractions between 10 and 70% depending on the space heating demand of the building and the size of the solar thermal system used.

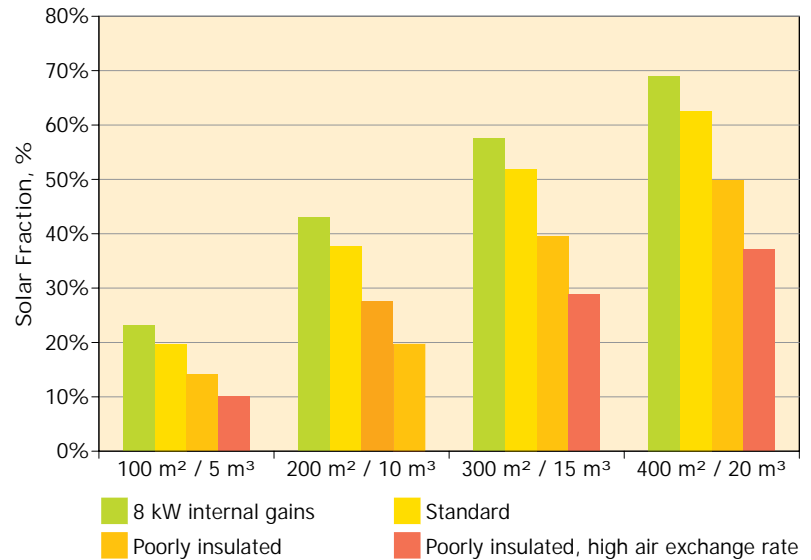

4.2.1

4.2.1 Dimensioning Nomogram

To avoid detailed simulation calculations in the pre-planning phase, generally applicable dimensioning nomograms were developed to allow a rapid and reliable estimate of the collector area and the solar storage tank volume for space heating applications in factory buildings. Apart from the key data for the solar thermal system, the solar fraction to be expected for the project in question and the specific solar yield can be read off the nomogram. The nomograms have the advantage that if the annual heating requirement for space heating is already known, the key data for the solar thermal system can be determined.

To simplify the use of nomograms, the “utilisation ratio” is defined as an important auxiliary characteristic number. This is a measure for the dimensioning of solar thermal systems and describes the ratio of annual consumption (in kWh) to the collector area in m².

$$\text{Utilization ratio}_{\text{total heat requirement}} = \frac{\text{Annual heat requirement} \left[\frac{\text{kWh}}{\text{a} \cdot \text{m}^2} \right]}{\text{Gross collector area}}$$

It should be remembered that the following nomograms are only suitable for the design of solar thermal systems in factory buildings similar to the calculated reference cases and for similar boundary conditions as described above.

If the simulation results of the reference cases are plotted as a function of the utilization ratio, all simulated points almost fall onto a single line that is decreasing with increasing utilization ratio. Towards the left, the collector area is increased, to the right it is decreased. The larger the collector area and the smaller the heat demand is, the higher is the solar fraction. High levels of utilization

Fig. 15

Nomogram to determine the collector area and the solar fraction and at the same time the specific collector yield. The graph is based on a specific storage tank volume of 50 liters per m^2 of collector area.

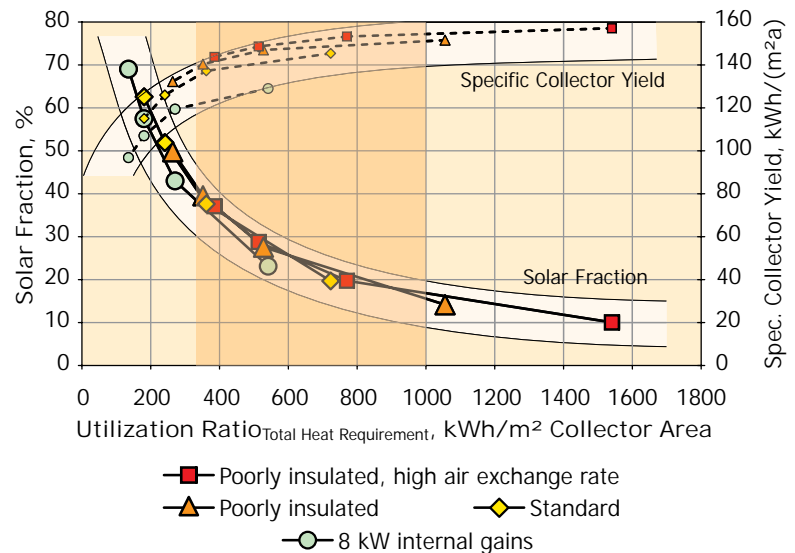

signify low degrees of solar fraction and vice versa. The specific yield shows the well-known behavior running contrary to the solar fraction.

The only points that are slightly lower than the overall trend curve are the ones that represent Case 4 (with high internal loads). In this case, the internal loads occur always during the daytime (i.e., at the same time when there is solar yield). Because of the internal loads there is no heat demand during working hours but only at night and on the weekends. Therefore, the solar energy can never be used directly in the building but always has to be stored for later use. Therefore, more storage tank losses occur compared to a building that has space heating demand also during the day.

The light-colored areas in the diagram show the typical range of solar fractions and specific collector yields that are reached with systems using the storage tank concept. Particularly in industrial buildings, economic considerations dominate that is why systems should be designed in accordance with the optimum ratio of cost-to-benefit. This is shown in Figure 15 by the area marked in orange and signifies degrees of solar fraction of the overall heating requirement between 15 and 40%. Degrees of solar fraction of less than 15% are outside the cost-to-benefit optimum since the (slight) rise in the specific yield does not make up for the higher specific system costs of a smaller solar thermal system and would thus lead to higher solar heating costs.

4.2.2 Handling of the Nomogram

The nomograms can be used in two different ways. The first method is to find out an approximate value for the solar fraction for a given collector area, system configuration and heat demand of the building. However, it can also be used the other way around by reading off the required collector area for a desired solar fraction and system configuration if the heat demand of the building is known. Refer to the box below for an example calculation of the second method of use.

- Determination of solar fraction

If the annual heating requirement has been determined, the utilization ratio for a particular planning project can be calculated by dividing this value by the collector area. If a vertical line is drawn through the point of the determined utilization ratio, then the intersection with the curve of the solar fraction is obtained and the value can be read off on the left ordinate. The same is true for reading off the specific yield on the right ordinate.

- Determination of collector area

If a desired solar fraction constitutes the starting point then a horizontal line can be placed at the

corresponding height. The point intersecting with the curve of the solar fraction then allows the necessary utilization ratio to be read off on the abscissa. The necessary collector area is obtained by dividing the annual heating requirement for space heating by the utilization ratio. The solar storage tank volume of 50 l/m² is directly proportional in this nomogram to the collector area.

Example

- Heating energy requirement of a factory building: approx. 70,000 kWh/a
- Desired solar fraction of overall annual heat requirement: approx. 30%

How to use the nomogram:

1. Determination of utilization for a desired solar fraction (example 30%)

A horizontal line is placed through the 30% mark on the left ordinate (solar fraction). A vertical line through the intersecting point of this line with the solar fraction curve in the diagram allows the utilization to be read off on the abscissa. Reading value for utilization ratio: approx. 500 kWh/m² of collector area and year

2. Determination of collector area required

The overall heating requirement (70,000 kWh/a) is divided by the utilization ratio determined in step 1 (500 kWh/m² a). The result is the collector area.

$$\text{Collector area [m}^2\text{]} = \frac{\text{Total heat requirement} \left[\frac{\text{kWh}}{\text{a}} \right]}{\text{Utilization ratio} \left[\frac{\text{kWh}}{\text{m}^2 \cdot \text{a}} \right]}$$

$$\text{Collector area} = \frac{70,000 \frac{\text{kWh}}{\text{a}}}{500 \frac{\text{kWh}}{\text{m}^2 \cdot \text{a}}} = 140 \text{ m}^2$$

To obtain 30% solar coverage, the necessary collector area would have to be around 140 m².

3. Determination of solar storage tank volume

This nomogram is based on a specific solar storage tank volume of 50 liters for each m². If the calculated collector area is multiplied by the specific solar storage tank volume, the overall solar storage tank volume is obtained.

$$\text{Solar storage tank volume} = 140 [\text{m}^2] \times 50 [\text{l/m}^2] = 7,000 \text{ l}$$

The solar storage tank volume required is around 7,000 liters.

4. Determination of specific solar yield

The specific solar yield to be expected can be read off at the point of intersection of the vertical line through the utilization ratio (500 kWh/m²a) with the upper curve in the diagram.

In this example, an annual specific solar yield of around 140 kWh can be attained per m² of collector area.

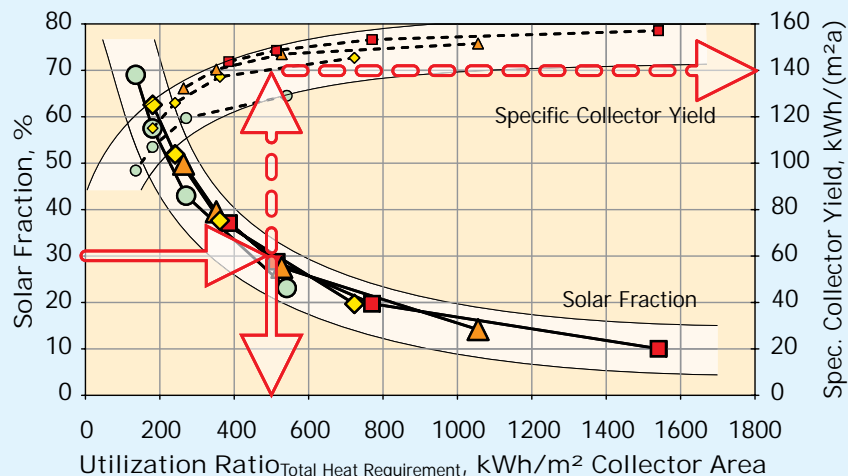

The solar storage tank volume does not influence the solar fraction to the same extent as the collector area. For this reason, the nomogram in Figure 15 is based on a set specific solar storage tank volume of 50 liters per m^2 of collector area. This value is reasonable for solar thermal systems designed with regard to an optimum cost-to-benefit ratio. If solar thermal systems are to be designed with higher solar fractions it is recommended that larger specific solar storage tank volumes should be selected.

4.2.3 Dimensioning nomogram with variable specific solar storage volume

The nomogram in Figure 16 can be used to determine the influence of the solar storage tank volume on the solar fraction. Via the auxiliary characteristic for “utilization ratio” this nomogram allows the flexible and generally applicable selection of the collector area and solar storage tank volume in connection with the solar fraction. For solar fractions in the cost/benefit optimum (15 to 30%) specific solar storage tank volumes from 30 to 50 l/m^2 can be recommended.

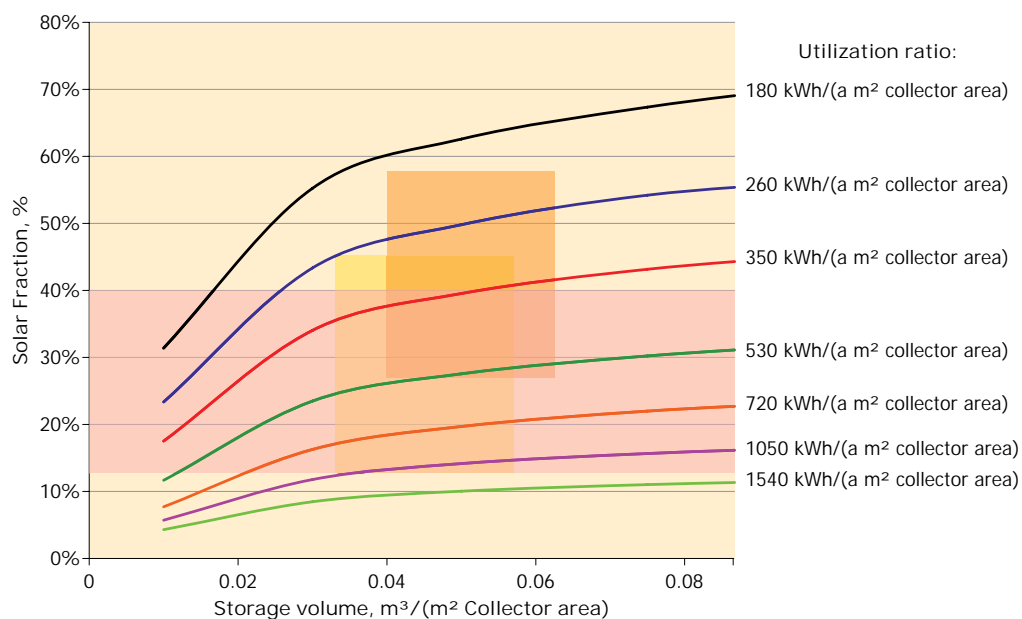

Fig. 16 *Nomogram to determine the collector area and the volume of the storage tank in relation to the solar fraction. The light orange area shows the recommended design limits in the cost-benefit optimization. The sensible areas to determine the specific volume of the storage tank depend on the solar fraction and are shown as rectangles.*

Handling the nomogram

If a desired solar fraction represents the situation at the start, then a horizontal line can be placed through this value. The point intersecting with the vertical line through the selected specific solar storage tank volume, gives the utilization ratio. The exact utilization ratio can be determined by interpolating between the plotted utilization curves. If the overall heat requirement is divided by the utilization ratio this results in the required collector area.

4.3 Concrete Floor Slab as Heat Store

This section deals with systems that use the thermal mass of the concrete as heat storage and do without a conventional water-filled storage tank.

4.3.1 Heat Exchanger Between Collector and Underfloor Heating System

In section 3, two different system concepts were shown: With and without a heat exchanger between collector field and underfloor heating system. Simulations of the reference building show an increase in solar fraction without the heat exchanger of about 1 - 2 percentage points.

Fig. 17 *Solar fraction for the standard reference building for the system concept without storage tank. The orange columns are with a heat exchanger in the collector loop. The grey columns on top show the increase when the heat exchanger is omitted.*

Because of this relatively small increase in the solar fraction and the fact that for systems without heat exchangers a large amount of antifreeze fluid is necessary, most realized systems include a heat exchanger. Therefore, all results shown in the following sections were calculated using the hydraulic layout with a heat exchanger between collector and underfloor heating system (Figure 11).

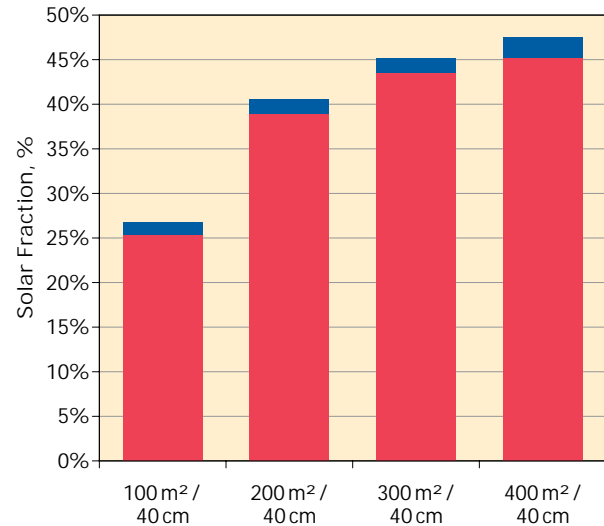

4.3.2 Thickness of Concrete Slab

Simulations were carried out for concrete slabs of 20, 40 and 60 cm thickness. However, the piping of the underfloor heating system was always installed at a depth of 10 cm.

Figure 18 shows the simulation results for the standard reference building with 20, 40 and 60 cm of floor slab. The floor thickness shows only a small sensitivity with respect to the solar fraction that can be reached with the system. Doubling or even tripling the floor thickness leads to an increase in solar fraction of only a few percentage points.

Therefore, a floor thickness around 30 - 50 cm is a reasonable value to be used for factory buildings with underfloor heating systems. Floor slabs in this order of magnitude are commonly used in many industrial buildings anyway.

One may think that installing the piping of the underfloor heating system deeper in the concrete can increase the storage capacity of the floor. To verify this, simulations were conducted. The results of these simulations showed that the installation depth of the piping had only a very small influence on the storage capacity of the concrete slab.

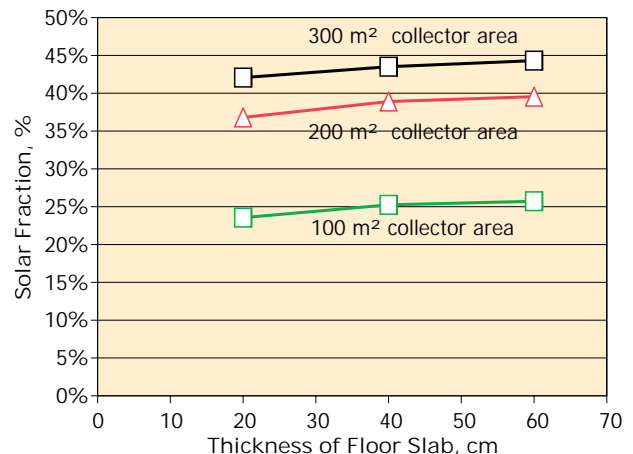

Fig. 18 *Influence of the thickness of floor slab on the solar fraction (standard reference building).*

4.3.3 Results for Reference Cases

Figure 19 below shows the simulations results of the four reference cases using the thermal mass of the concrete slab as heat storage. All results shown in the following diagrams were simulated using 40 cm of concrete slab.

Fig. 19 *Solar fraction reached with different system sizes (thickness of concrete slab: 40 cm).*

Solar fractions reached values from 8 to 47%. Interestingly enough, the solar fractions for the green case (8 kW internal gains), which has the lowest overall heat demand, are not always higher than those for the reference case.

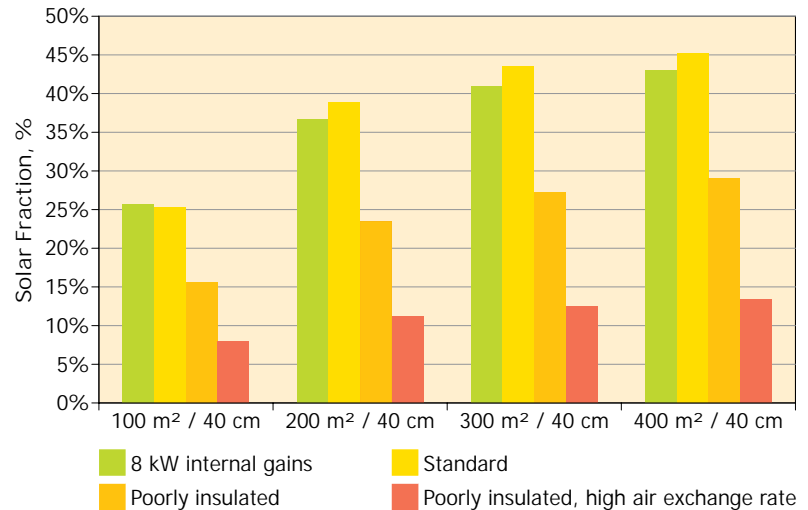

4.3.4 Dimensioning Nomogram

When the results are plotted against the utilization ratio, as it was done for the system concept with storage tank, the points scatter significantly more (see Figure 20).

The highest solar fractions are obtained with the standard reference case.

In Case 4 (8 kW internal gains), solar fractions are lower because during the day the machine operation leads to high air temperatures and high floor temperatures, therefore the solar thermal system cannot store much heat in the concrete mass. As soon as a maximum floor temperature is reached the system has to be switched off. In this case, using the thermal mass as a storage tank is particular unfavorable because the solar energy from the sun cannot be stored to be used during the night.

Fig. 20 *Nomogram to determine the collector area, the solar fraction and at the same time the specific collector yield. The graph is based on a concrete slab thickness of 40 cm.*

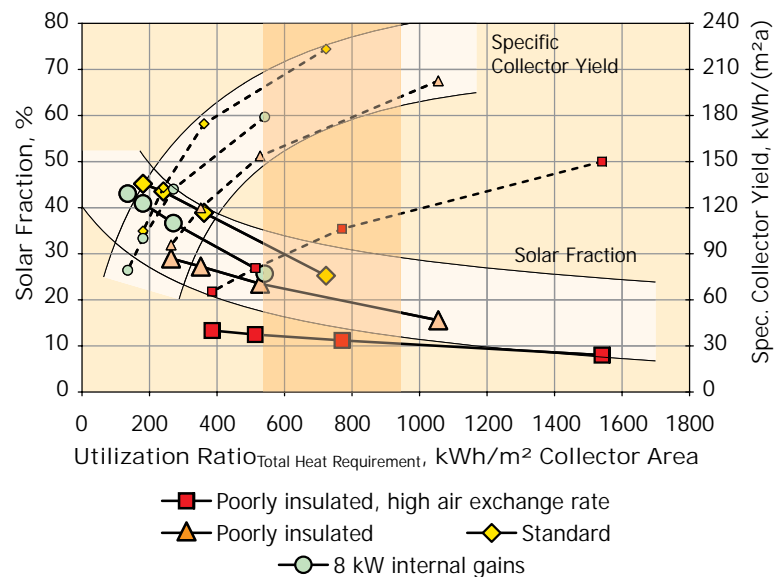

In Case 2 (poorly insulated), solar fractions are again lower. In this case, the overall heat demand of the building is much higher and as a result the conventional heating system is turned on more often. The conventional heating system also uses the underfloor heating system, which leads to higher average floor temperatures. If this is the case, then the potential for solar heat to be stored in the floor is decreased, which in turn decreases the solar fraction that can be reached.

This effect is even more pronounced in Case 1 (poorly insulated and high air exchange rate). In this case, the overall heat demand of the building is so high that the conventional heating system has to be turned on almost all the time. Therefore, solar fractions are decreased dramatically.

In Figure 20, the light-colored area shows the band of the solar fractions for solar heating systems in factory buildings that use only the concrete slab as heat store. The light-colored area excludes Case 1 because the simulation results have shown that using only the thermal mass as heat store for buildings with very high heat demands does not make sense.

The specific collector yields can be significantly higher compared to the cases where a storage tank was used. The reason for this is that the control strategy for thermal mass usage "overheats" the building to a certain extent. This does not necessarily decrease the auxiliary heat demand.

Regarding the nomogram for systems using the concrete slab as heat store, it is even more important to remember that the results shown can only give a rough approximation of the solar fractions that can be reached with such a system. The results are only strictly valid for the reference buildings described above. Systems without water store are even more sensitive to a change of boundary conditions as could be shown with the different reference cases considered.

If for example, a building is much higher than the reference buildings or a higher air temperature is required, this can have a strong influence on the function of the concrete slab as a heat store. It not only increases the heat demand of the building but also decreases the solar fraction that can be reached. Therefore, a more detailed simulation of the building and the heating system may be necessary if the thermal mass is to be used as the only heat store.

As for systems that use a water storage tank, systems should be designed in accordance with the optimum cost-to-benefit ratio. This is shown in Figure 20 by the area marked in orange and signifies degrees of solar fraction of the overall heating requirement between 15 and 30%. Degrees of solar fraction of less than 15% are outside the cost-to-benefit optimum since the (slight) rise in the specific yield does not make up for the higher specific system costs of a smaller solar thermal system and would thus lead to higher solar heating costs.

4.4 Comparison of Water Storage Tank vs. Thermal Mass

To compare the solar fractions that are reached with the two system concepts with and without a conventional storage tank, the ranges of solar fractions from both nomograms described above are shown in a single diagram (Figure 21).

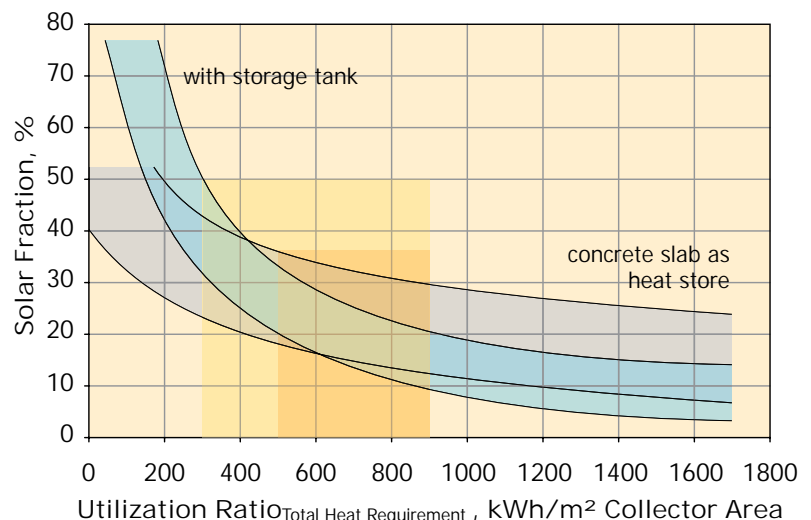

Fig. 21 *Nomogram to determine the collector area and the solar fraction and at the same time the specific collector yield. The graph is based on a concrete slab thickness of 40 cm.*

The areas of system design according to the cost-to-benefit optimum are marked by yellow and orange rectangles. For systems with a storage tank, this cost-to-benefit optimum goes to higher solar fractions and thus lower utilization ratios. Because of the limited storage capacities of the concrete slab, significantly larger collector areas are necessary to reach the same high solar fractions with a conventional storage tank. Therefore, the cost-to-benefit optimum for systems using the concrete slab as a heat store has been limited to a solar fraction of 30%. Please note that this is only an approximate value and depends strongly on the boundary conditions of each project.

5 Conclusions

Based on the work conducted in Task 33/IV, we have concluded that solar thermal energy is a good solution for space heating of industrial buildings if there is not enough waste heat available from the company's operations. When considering solar thermal energy for space heating of a factory building, the first steps should then be to reduce the heat demand of the building as much as possible by insulating the building and reducing infiltration losses (e.g., loading docks instead of open doors).

The nomograms in this booklet were developed to provide a means for rough dimensioning typical system configurations. Two system concepts were analyzed and described in detail: A system concept with a water storage tank and a system concept using the concrete floor slab as storage medium.

If the utilization ratio is high, the solar fractions that can be reached are similar for both system concepts. Solar fractions reached with systems without storage tank can even be higher compared to systems with storage tanks. High utilization ratio means that either one or both the collector area or the heat requirement is low. In these cases, the cheaper system concept without a storage tank makes a lot of sense. However, if the heat requirement is relatively large or if very high solar fractions should be reached, the system concept with a storage tank has an advantage compared to systems that use only the thermal mass of the concrete slab as storage medium.

It should be noted that the option of having no storage tank and reaching a 100% solar fraction is feasible if an air temperature in the building that sometimes falls below the desired set value would be tolerated (see example Winkler).

6 Appendix 1: Description of the IEA Solar Heating and Cooling Programme

The *International Energy Agency* (IEA) is an autonomous body within the framework of the Organization for Economic Co-operation and Development (OECD) based in Paris. Established in 1974 after the first "oil shock," the IEA is committed to carrying out a comprehensive program of energy cooperation among its members and the Commission of the European Communities.

The IEA provides a legal framework, through IEA Implementing Agreements such as the *Solar Heating and Cooling Agreement*, for international collaboration in energy technology research and development (R&D) and deployment. This IEA experience has proved that such collaboration contributes significantly to faster technological progress, while reducing costs; to eliminating technological risks and duplication of efforts; and to creating numerous other benefits, such as swifter expansion of the knowledge base and easier harmonization of standards.

The *Solar Heating and Cooling Programme* was one of the first IEA Implementing Agreements to be established. Since 1977, its members have been collaborating to advance active solar and passive solar and their application in buildings and other areas, such as agriculture and industry. Current members are:

Australia	European Commission	Mexico	Spain
Austria	Germany	Netherlands	Sweden
Belgium	Finland	New Zealand	Switzerland
Canada	France	Norway	United States
Denmark	Italy	Portugal	

A total of 39 Tasks have been initiated, 30 of which have been completed. Each Task is managed by an Operating Agent from one of the participating countries. Overall control of the program rests with an Executive Committee comprised of one representative from each contracting party to the Implementing Agreement. In addition to the Task work, a number of special activities-Memorandum of Understanding with solar thermal trade organizations, statistics collection and analysis, conferences and workshops-have been undertaken.

The Tasks of the IEA Solar Heating and Cooling Programme, both underway and completed are as follows:

6.0.1 Current Tasks:

Task 32	Advanced Storage Concepts for Solar and Low Energy Buildings
Task 33	Solar Heat for Industrial Processes
Task 34	Testing and Validation of Building Energy Simulation Tools
Task 35	PV/Thermal Solar Systems
Task 36	Solar Resource Knowledge Management
Task 37	Advanced Housing Renovation with Solar & Conservation
Task 38	Solar Assisted Cooling Systems
Task 39	Polymeric Materials for Solar Thermal Applications

6.0.2 Completed Tasks:

Task 1	Investigation of the Performance of Solar Heating and Cooling Systems
Task 2	Coordination of Solar Heating and Cooling R&D
Task 3	Performance Testing of Solar Collectors

Task 4	Development of an Insolation Handbook and Instrument Package
Task 5	Use of Existing Meteorological Information for Solar Energy Application
Task 6	Performance of Solar Systems Using Evacuated Collectors
Task 7	Central Solar Heating Plants with Seasonal Storage
Task 8	Passive and Hybrid Solar Low Energy Buildings
Task 9	Solar Radiation and Pyranometry Studies
Task 10	Solar Materials R&D
Task 11	Passive and Hybrid Solar Commercial Buildings
Task 12	Building Energy Analysis and Design Tools for Solar Applications
Task 13	Advance Solar Low Energy Buildings
Task 14	Advance Active Solar Energy Systems
Task 16	Photovoltaics in Buildings
Task 17	Measuring and Modeling Spectral Radiation
Task 18	Advanced Glazing and Associated Materials for Solar and Building Applications
Task 19	Solar Air Systems
Task 20	Solar Energy in Building Renovation
Task 21	Daylight in Buildings
Task 23	Optimization of Solar Energy Use in Large Buildings
Task 22	Building Energy Analysis Tools
Task 24	Solar Procurement
Task 25	Solar Assisted Air Conditioning of Buildings
Task 26	Solar Combisystems
Task 28	Solar Sustainable Housing
Task 27	Performance of Solar Facade Components
Task 29	Solar Crop Drying
Task 31	Daylighting Buildings in the 21 st Century

6.0.3 Completed Working Groups:

CSHPSS, ISOLDE, Materials in Solar Thermal Collectors, and the Evaluation of Task 13 Houses

To find Solar Heating and Cooling Programme publications and learn more about the Programme visit www.iea-shc.org or contact the SHC Executive Secretary, Pamela Murphy, e-mail: pmurphy@MorseAssociatesInc.com.

7 Appendix 2: Description of Task 33/IV Solar Heat for Industrial Processes

Task 33/IV was a collaborative project of the Solar Heating and Cooling Program and the SolarPACES program of the International Energy Agency (IEA) in which 16 institutes and 11 companies from Australia, Austria, Germany, Italy, Spain, Portugal, Mexico were involved. The aim of the project was the development of solar thermal plants for industrial process heat.

To reach this goal, studies on the potential for this technology were carried out for the countries involved, medium-temperature collectors were developed for the production of process heat up to a temperature of 250°C, and solutions were sought to the problems of integrating the solar heat system into industrial processes.

In addition, demonstration projects were realised in cooperation with the solar industry.

Knowledge was transferred to industry via industry newsletters, by holding relevant conferences as well as through the following four booklets:

- Design Guidelines — Solar Space Heating of Factory Buildings
- Medium Temperature Collectors
- Pilot Plants — Solar Heat for Industrial Processes
- Potential for Solar Heat in Industrial Processes

Further information: www.iea-shc.org/task33

7.1 TASK 33/IV Participants

Operating Agent:	Werner Weiss	AEE INTEC Feldgasse 19 A-8200 Gleisdorf, Austria
Australia	Wes Stein	Lucas Heights Science & Technology Centre New Illawarra Rd, Lucas Heights NSW, PMB 7 Bangor NSW 2234
Austria	Werner Weiss, Dagmar Jähnig and Thomas Müller	AEE INTEC AEE - Institute for Sustainable Technologies Feldgasse 19 A-8200 Gleisdorf
	Hans Schnitzer and Christoph Brunner	Joanneum Research Elisabethstrasse 16/1 A-8010 Graz
	Gernot Gwehenberger	Technical University of Graz RNS Inffeldgasse 25c A-8010 Graz
Germany	Klaus Vajen and Elimar Frank	Kassel University Department of Mechanical Engineering Solar and System Technology D-34109 Kassel

	Andreas Häberle	PSE GmbH Emmy-Noether Str. 2 D-79110 Freiburg
	Klaus Hennecke	DLR Institut für Technische Thermodynamik D-51170 Köln
	Matthias Rommel	Fraunhofer ISE Heidenhofstrasse 2 D-79110 Freiburg
	Stephan Fischer	ITW, Stuttgart University Pfaffenwaldring 6 D-70550 Stuttgart
	Markus Peter	dp2 - Energienutzung mit Verstand Michelsweg 29 D- 59494 Soest
Italy	Riccardo Battisti, Annalisa Corrado, Claudia Vannoni and Serena Drigo	University of Rome "La Sapienza" Department of Mechanical and Aeronautical Engineering Via Eudossiana 18 00184 Rome
Mexico	Claudio Estrada	CIE-UNAM Privada Xochicalco, S/N, Col. Centro Cuernavaca, Mor., Mexico
Portugal	Maria Joao Carvalho	INETI Edificio H, Estrada do Paço do Lumiar, 22 1649-038 Lisboa
Spain	Esther Rojas Bravo	CIEMAT-PSA Avda. Complutense, 22, Edificio 42 28040 Madrid
	Gonzalez i Castellví	AIGUASOL Engineering C/ Roger de Llúria, 29 3er 2a 08009 Barcelona
	Hans Schweiger	Ingeniería Termo-energética y Energías Renovables Creu dels Molers, 15, 2o 1a 08004 Barcelona

Solar Fraction, %

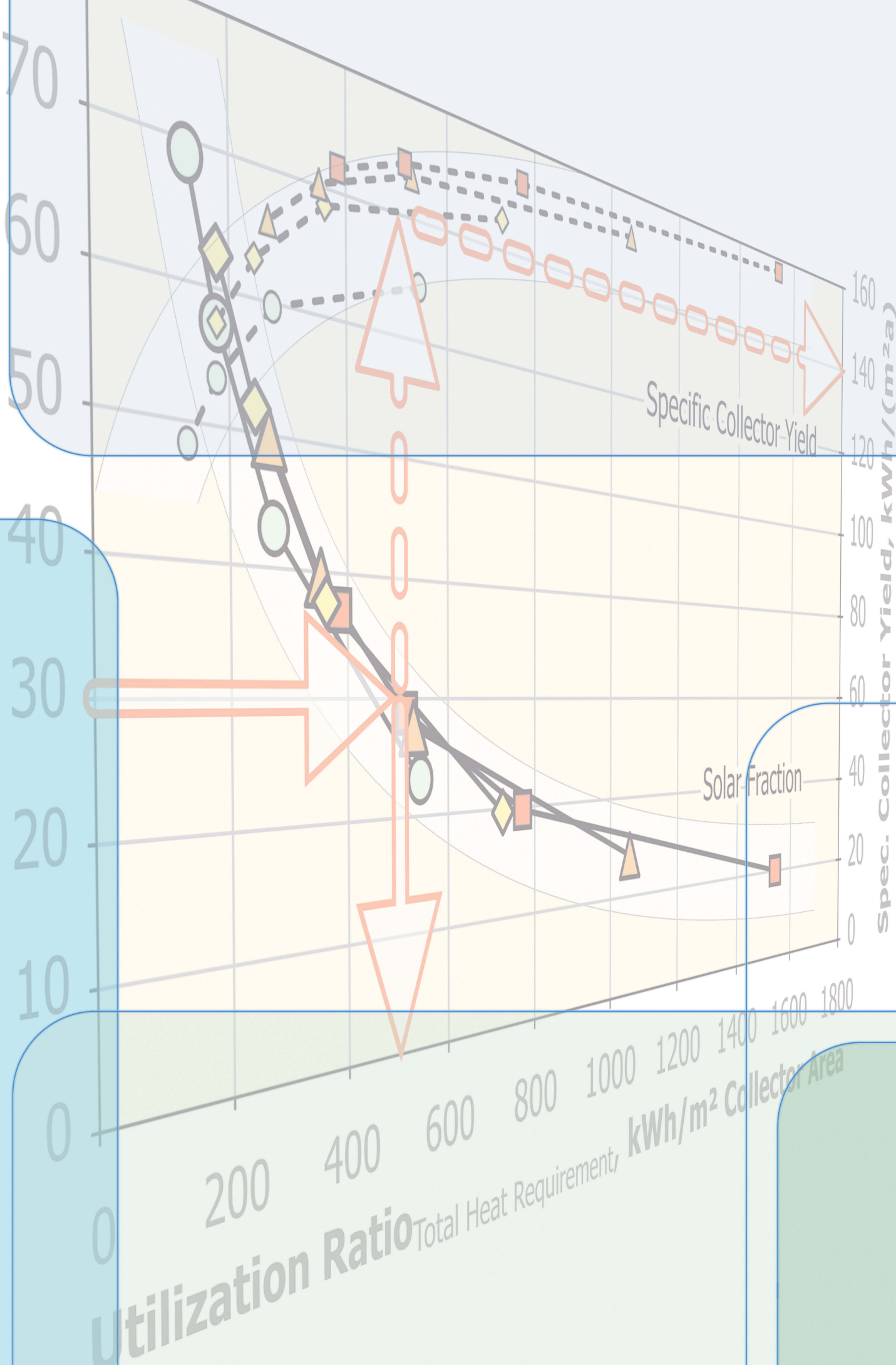

Utilization Ratio

Total Heat Requirement, kWh/m² Collector Area

Specific Collector-Yield

Solar-Fraction