

Biogas from Crop Digestion

Jerry MURPHY
Rudolf BRAUN
Peter WEILAND
Arthur WELLINGER



IEA Bioenergy

Task 37 - Energy from Biogas

IEA Bioenergy aims to accelerate the use of environmentally sound and cost competitive bioenergy on a sustainable basis and thereby achieve a substantial contribution to future energy demands

The following countries are members of Task 37 in the 2010 – 2012 Work Programme

Austria	Bernhard DROSG, bernhard.drosg@boku.ac.at Günther BOCHMANN, guenther.bochmann@boku.ac.at
Brazil	José GERALDO de MELO, furtada@cepel.br Guilherme FLEURY W. SOARES, fleury@cepel.br
Canada	Andrew McFARLAN, andrew.mcfarlan@nrcan.gc.ca
Denmark	Teodorita AL SEADI, teodorita.alseadi@biosantech.com
European Commission (Task Leader)	David BAXTER, david.baxter@jrc.nl
Finland	Jukka RINTALA, jukka.rintala@byti.jyu.fi Annamari LEHTOMAKI, Annamari.Lehtomaki@jklinnovation.fi
France	Olivier THÉOBALD, olivier.theobald@ademe.fr Guillaume BASTIDE, guillaume.bastide@ademe.fr
Germany	Bernd LINKE, blinke@@atb-potsdam.de
Ireland	Jerry MURPHY, jerry.murphy@ucc.ie
Netherlands	Mathieu DUMONT, mathieu.dumont@agentschapnl.nl
Norway	Espen GOVASMAR, espen.govasmark@bioforsk.no
Sweden	Anneli PETERSSON, anneli.petersson@sgc.se
Switzerland	Nathalie BACHMANN, nathalie.bachmann@erep.ch
Turkey	Selman CAGMAN; Selman.Cagman@mam.gov.tr Volkan ÇOBAN, Volkan.Coban@mam.gov.tr
United Kingdom	Clare LUKEHURST, clare.lukehurst@green-ways.eclipse.co.uk

Written by:

Jerry MURPHY
Environmental Research Institute
University College Cork
Ireland

Peter WEILAND
Institut für Agrartechnologie und Biosystemtechnik
Bundesallee 50,
38116 Braunschweig, Germany

Rudolf BRAUN
Institut für Umweltbiotechnologie
Konrad Lorenzstrasse 20
A-3430 Tulln, Austria

Arthur WELLINGER
Nova Energie GmbH
Châtelstrasse 21
CH-8355 Aadorf
Switzerland

DATE OF PUBLICATION: September 2011

IMPRESSUM

Graphic Design: Susanne AUER

Contents

1. Introduction	4
1.1 The world's energy supply – A future challenge	4
1.2 Development of crop digestion	4
1.3 Crops used in anaerobic digestion	5
2. Technology for anaerobic digestion of crops	6
2.1 Harvest, pre-processing and storage of crops	6
2.2 The anaerobic process configuration and process control	7
2.3 Treatment, storage and usage of digestate	8
2.4 Treatment, storage and use of biogas	8
3. Application of crop digestion	10
3.1 Co-digestion and mono-digestion of crops	10
3.2 An example of mono-digestion of crops	10
3.3 An example of co-digestion of crops	11
3.4 An example of continuous dry-fermentation of crops	13
3.5 An example of crop conversion to gaseous biofuel	14
4. Experience in crop digestion	15
4.1 Number of crop digestion plants in different countries	15
4.2 Full-scale crop digestion plants in Austria	15
4.3 Full-scale crop digestion plants in Germany	16
5. Significance and potential of crop digestion	17
5.1 Crop digestion and agricultural sustainability	17
5.2 Biogas yield per hectare of crops	17
5.3 Net energy yield per hectare of crops	18
5.4 Profitability of crop digestion	19
6. Potential for biogas from crops	20
6.1 Future significance of biogas from biomass	20
6.2 Theoretical potential of biogas from crops	21
7. Conclusions and recommendations	21
Citations	22
Further reading	23
Glossary, terms	23
Abbreviations	23

1. Introduction

This brochure is a revision of the 2009 IEA Bioenergy Task 37 “Biogas from Energy Crop Digestion” technical brochure.

1.1 The world's energy supply – A future challenge

Currently about 80 % of the world's overall energy supply (ca. 400 EJ per year) is derived from fossil fuels. Biomass is by far the most important renewable energy source used to date, supplying 10-15 % of energy supply.

On average, in industrialised countries biomass contributes 9-13% of the total energy supply, but in developing countries this proportion is much higher. In Sub-Saharan Africa biomass supplies 70 to 90% of the total energy demand.

Biomass combustion is responsible for over 90% of the current production of energy from biomass. Liquid biofuels (e.g. ethanol and biodiesel) contribute only a small portion of biomass energy. First generation ethanol is produced from sugar or starch crops, while biodiesel is derived from vegetable oils or animal fats.

Currently biogas plays a smaller, but steadily growing role. Energy recovery from biogas by anaerobic digestion (AD) has been a welcome by-product of sewage sludge treatment for a number of decades. However, biogas has become a well established energy resource, especially through the use of biomass residues or crops. Since the 1950's, biogas production from manure and / or crops has continued to develop as an important new farm enterprise in countries such as Austria, Denmark and Germany.

1.2 Development of crop digestion

The concept of crops for methane production (anaerobic digestion, biogas, methanisation or biomethanation) is not new. Early investigations on the biomethanation potential of different crops and plant materials were carried out in the 1930's in the USA (Buswell and Hatfield, 1936), in the 1950's in Germany (Reinhold and Noack, 1956), and in the 1980's in

New Zealand (Stewart et al., 1984). Although the digestion of crop material was demonstrated, the process was hardly applied in practice. Crop digestion was not considered to be economically feasible. Crops, crop by-products and waste materials were occasionally added to stabilise anaerobic waste digesters.

In the 1990's steadily increasing oil prices and improved legal framework conditions, stimulated crop research and development. In Germany for example, the number of digesters using crops was 100 in 1990. At the end of 2010 approximately 6,000 biogas plants were in operation in Germany (figure 1). The majority use a mixture of manure and crops; 90-95 % of all plants (between 5,400 and 5,700 plants) use crops. Several biogas plants employ mono-digestion.

The steady increase in crop digesters in Germany can be directly attributed to the favourable supportive national legal framework coupled with the tariffs paid for renewable energy. Staggered feed-in tariffs (which depend on the electrical power capacity of the biogas plants) are guaranteed for the whole depreciation period of the investment. Feed-in tariffs also exist in other countries, for instance in Switzerland, the Netherlands and France. Other European countries apply tax exemptions (e.g. Sweden) or a choice of certificates and feed-in tariffs (e.g. UK) for renewable energy. France, Switzerland or Sweden do not offer subsidies specifically for crop digestion.

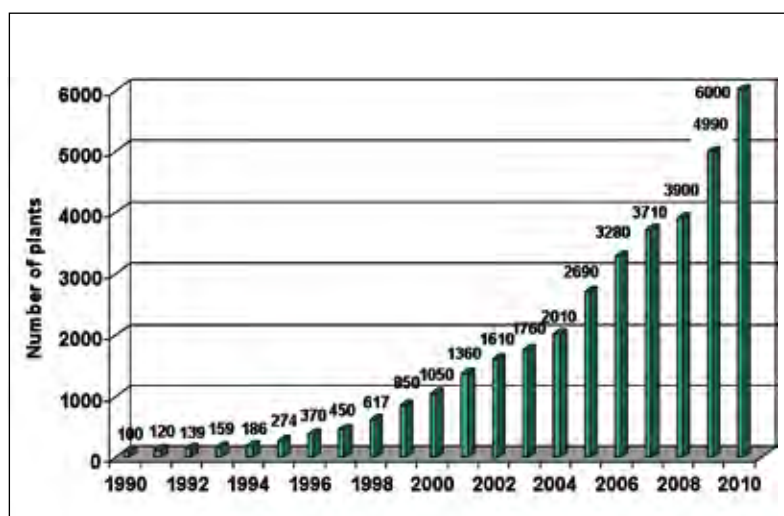

Figure 1: Increasing number of biogas plants in Germany between 1990 and 2010 (Weiland, 2010)

1.3 Crops used in anaerobic digestion

Numerous plant species and plant residues have been tested for their methane potential. In principal, many varieties of grass, clover, cereals and maize, including whole plants, as well as rape and sunflower proved feasible for methane production. Hemp, flax, nettle, potatoes, beets, kale, turnip, rhubarb and artichoke have all been tested successfully. Some crops used for digestion are shown in Photos 1 to 4.

The literature typically refers to methane production in terms of $\text{m}^3 \cdot \text{t}^{-1}$ Volatile Solids (VS). Volatile Solids refer to that portion of solids that are organic or dry and ash

free; solids that can either combust or biodegrade. For example, 1 t of Volatile Solid has an energy value of about 19 GJ while 1 m_n^3 of methane (CH_4) has an energy value of ca. 38 MJ. Thus for conservation of energy the maximum production of methane is $500 \text{ m}_n^3 \cdot \text{t}^{-1}$ VS ($500 \text{ m}_n^3 \text{ CH}_4 * 38 \text{ MJ}/\text{m}_n^3 = 19,000 \text{ MJ} = 19 \text{ GJ} = 1 \text{ t VS}$). This value may increase for example due to the presence of alcohols and acids in silage liquors. Depending on specific process conditions, a fairly wide range of methane yields, between $120\text{--}658 \text{ m}_n^3 \cdot \text{t}^{-1}$ VS_{added}, is reported in the literature from anaerobic digestion of different crops (Table 1). Recent German practical experience showed mean methane yields of $348 \text{ m}_n^3 \cdot \text{t}^{-1}$ VS for ensiled maize and $380 \text{ m}_n^3 \cdot \text{t}^{-1}$ VS for whole plant ensiled barley (KTBL, 2009). A comprehensive data bank on crop yields, appropriate climate and growth conditions was elaborated in the recent EU funded “CROPGEN” project (Cropgen, 2011).

Crops may be used for digestion directly after harvest. For year round availability of substrates, crops are frequently stored in silage clamps. Grass, for example, may be ensiled in a clamp or pit or it may be baled. In Irish conditions pit silage has a dry solids (DS) content of approximately 22% while bale silage has a dry solids content of about 30%. In drier climates such as Austria, grass is wilted (partially dried after cutting) prior to collection from the field and the resulting silage can have a dry solids content of up to 40%. The time of harvest varies for differing crops. Grass may be cut between two and five times in a season; the first harvest is as early as May (in the northern hemisphere). Sugar beet is harvested later than most crops, typically between November and

Tab. 1: Examples of methane yields from digestion of various plants and plant materials as reported in literature (Data compilation after Braun, 2007)

Methane yield (m^3 per tonne volatile solids added)

Maize (whole crop)	205–450	Barley	353–658
Wheat (grain)	384–426	Triticale	337–555
Oats (grain)	250–295	Sorghum	295–372
Rye (grain)	283–492	Peas	390
Grass	298–467	Alfalfa	340–500
Clover grass	290–390	Sudan grass	213–303
Red clover	300–350	Reed Canary Grass	340–430
Clover	345–350	Ryegrass	390–410
Hemp	355–409	Nettle	120–420
Flax	212	Miscanthus	179–218
Sunflower	154–400	Rhubarb	320–490
Oilseed rape	240–340	Turnip	314
Jerusalem artichoke	300–370	Kale	240–334
Potatoes	276–400	Chaff	270–316
Sugar beet	236–381	Straw	242–324
Fodder beet	420–500	Leaves	417–453

Photo 1: Maize, the most frequently used crop offering yields of 9 to 30 tons Dry Matter (DM) per hectare

Photo 2: Grass is frequently used as an energy crop, enabling 2–5 harvests per year under moderate climate conditions. Yields of 12–15 tons DM per hectare can be obtained.

Photo 3: Sugar beet offers yields of 50 tons per hectare, equivalent to 12 tons DM per hectare. It is an excellent feedstock as the sugar content is 18–23%.

Photo 4: Sun flower field at an early cultivation stage; sun flower is used for oil production as well as a crop for anaerobic digestion. Yields of 6–8 tons DM per hectare are possible.



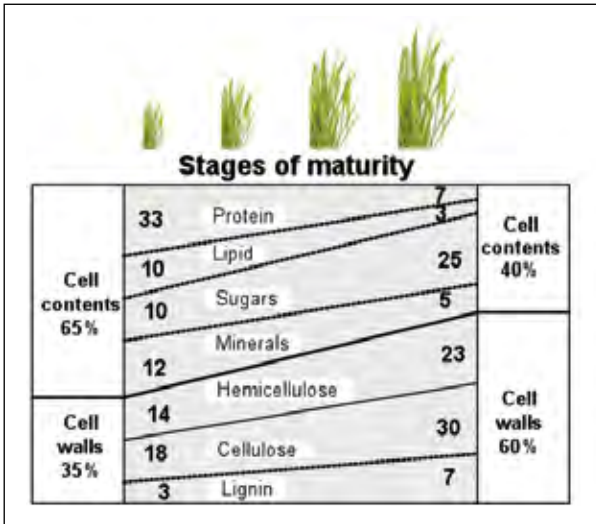

Figure 2: Phase composition of grass with advancing maturity (adapted from Holmes, 1980).

January. Staggered harvest improves the possibility for co-digestion of fresh crops and reduces the amount of storage capacity required. The time of harvest can influence bio-degradability, and hence the methane yield. Late harvest (with longer growing period) usually leads to higher lignin content in grasses (Figure 2), causing slower bio-degradation and lower methane yield. Work in Ireland indicated a yield of $440 \text{ m}^3 \text{ CH}_4 \cdot \text{t}^{-1} \text{ VS}_{\text{added}}$ for grass silage from an early harvest of perennial rye grass (Thamsiriroj & Murphy, 2011) though average values from the scientific literature are lower, reflecting the fact that later cuts have a higher fibre content.

2. Technology for anaerobic digestion of crops

Numerous technical solutions are offered by the industry all of which are based on the same basic principle. Four distinct steps can be defined for crop digestion processes:

- Harvest, pre-processing and storage of crops
- The anaerobic process configuration and process control
- Treatment, storage and use of digestate
- Treatment, storage and use of biogas

2.1 Harvest, pre-processing and storage of crops

A wide range of annual and perennial plant species may be used as crops for anaerobic digestion (Table 1). Maize is most widely used in the majority of existing biogas plants. Standard combine harvesters are used, which simultaneously chop the whole maize plant (Photo 5) for subsequent ensiling.

Ideally the biomass used for ensiling should have a dry solids content of between 20 and 40 %. The AD reactor system design should be adapted for the particular crop and the dry solids content of the crop. The dry solids content of some crops vary from country to country; grass silage in Ireland has a dry solids content between 22% (pit silage) and 30% (bale silage) while in Germany and Austria grass silage has a dry solids content of up to 40% (Smyth et al., 2009).

Optimal ensiling results in rapid lactic acid (5–10 %) and acetic acid fermentation (2–4 %), causing a decrease of the pH to 4–4.5 within several days. Butyric acid formation is usually prevented by the rapid pH decrease. Addition of acid or of commercially available ensiling additives can accelerate lactic acid fermentation. Under such conditions, silage may be stored for many months; losses from harvest to digester feed-in may account for between 15 and 25% of solids. Though not a widespread practice, sugar beet may be ensiled by cleaning, washing, mashing and ensiling, typically with straw. Alternatively chopped beets may be stored in a lagoon which is less costly than ensiling in a clamp. After 1 week lactic acid builds up, the pH drops below 4 and the ensiled beets may be stored for one year. Silage clamps (Photo 6) are



Photo 5: Typical maize harvesting, using a standard combine harvester



Photo 6: Ensiling procedure of whole crop chopped maize, using a front loader

commonly used for ensiling the crop material, in order to maintain a year round supply to the digester. Storage capacity for continuous digester operation over the year must be guaranteed. In a medium sized crop digestion installation, typically up to 10,000 tons of silage are prepared during harvest time for continuous use as a substrate (feedstock) over the year. For storage in silage clamps, shovel loaders thoroughly compact the crops and finally cover with plastic blankets to ensure air tightness. Ski slope preparation machines (also called ski bulls) have been adapted for use in feeding and compacting large clamps. A bag silo may be used in place of a clamp. These could be for example 3.5 m diameter and 100 m in length. The capacity of a typical bag silo storage is about 6,000 tons. Bag silos are filled using packing machines, which are able to load up to 100 t.h^{-1} , corresponding to 50 ha.d^{-1} harvest capacity. In smaller crop digestion plants, conventional big bale silos (capacity 660 kg of silage) are applied for silage preparation and storage. In some cases dry storage of substrates is possible (e.g. maize). Available surplus heat from a combined heat and power (CHP) unit may also be used for the drying process.

Figure 3: Reactor configurations (a) one step wet digestion (b) two step wet digestion (c) dry batch system (d) dry continuous system (Nizami and Murphy, 2010)

2.2 The anaerobic process configuration and process control

Typical configurations of digesters are outlined in Figure 3. Digesters may be wet with a dilute feedstock; an example of this is the ubiquitous continuously stirred tank reactor (CSTR). This may be a one step or preferably a two step process.

Alternatively, the reactor may be of a dry batch type with recirculation of liquor over the feedstock. The feedstock is enclosed in the reactor; gas production increases, peaks, decreases and ceases; half the feedstock is removed, the remainder is left as an inoculum for the next batch. The gas production for each batch is represented by a normal curve; thus numerous batch reactors are used, fed sequentially, to ensure relatively stable gas production over a long term.

Dry continuous systems may also be employed whereby the feedstock is circulated numerous times through the digester, without dilution, from an external liquid source; fresh feedstock is mixed with digestate and pumped through the plug flow system.

Fresh crops or silage can be used as substrate in most existing digester designs. Precautions have to be taken when fibrous (cellulosic) crop material is used. Cellulosic fibres degrade slowly. Fibres can form scum, block pumps, pipes or even the mixing equipment of the digester. When highly contaminated substrates (with sand or soil) are applied (e.g. beets, potatoes), solid deposits can

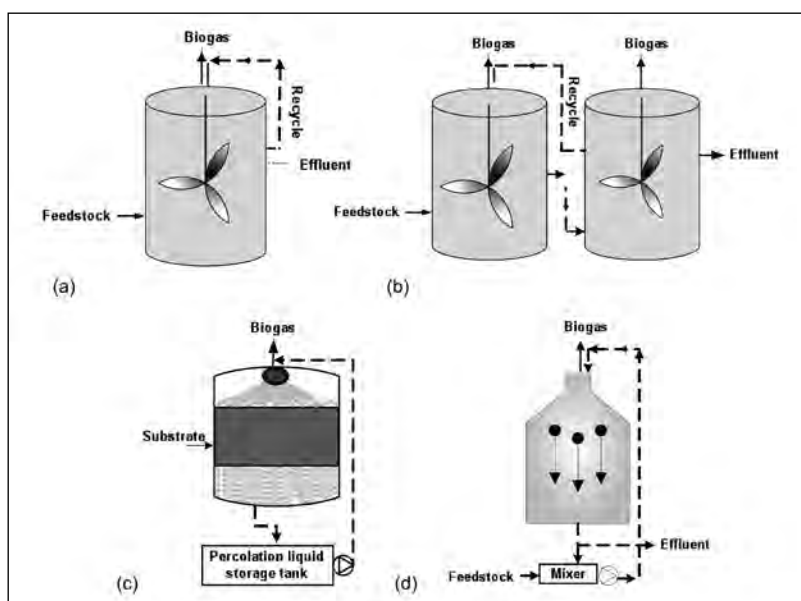

accumulate on the bottom of digester vessels and even pipes and pumps can be blocked. Grass silage has a tendency to float and thus maceration to small particle size is needed and the mixing system needs to ensure grass does not collect on the liquor surface. Appropriate measures have to be taken to deal with particular substrates including chopping, homogenisation, mixing and sand removal.

Ensiled crops typically have dry solids contents of 20 to 40 % while dry crop materials like grains can have even higher DS contents (up to 90 %). Such materials cannot be pumped or homogenised with conventional digester equipment. In this case the substrate needs to be chopped or milled before feeding. If using a wet digestion system, dilution may be required to maintain the dry matter content at a level suitable for the mixing equipment being used. When required, recycled digestate may be used for the purpose of substrate dilution. Alternatively a dry batch system may be used with recirculation of liquor over the feedstock (Figure 3c).

Large scale commercial crop digestion plants mainly use solid substrate feeding hoppers or container dosing units (Photo 7). Feed hoppers or containers are periodically filled with shovel loaders (e.g. once daily) and the material is continuously transported through gas tight auger tubes into the digester. Some applications use piston pumps instead of augers.

In digestion plants designed for manure, a small amount of crops is usually suspended within the digester effluent, or other raw liquid substrates, prior to conventional dosage with piston, displacement or rotary pumps. Some installations use more sophisticated liquid suspension feeding, applying continuous automatic substrate dosage and control. Even dry solid substrates are fed



Photo 7: Silage dosing unit (back) with spiral elevator (front). The silage clamps can be seen in the back.



Photo 8: Solid substrate grinder (right) as used for preparation of the dry substrates (maize) in anaerobic digestion of crops

after grinding (Photo 8), either directly into the digesters, or suspended in liquid digestate. Typically semi-continuous substrate dosing is applied, from daily to hourly feeding. Only large installations use continuous feeding.

Special care has to be taken in case of substrate changes. Changing composition, fluid dynamics and biodegradability of some substrate components can severely change the digestion behaviour, lowering gas yield and even cause digester failures. These can result from overloading, clogging of pipes and pumps, or interference with the mixing system.

In the case of a substrate change, new co-substrate addition or any substantial changes of the dosage, special attention has to be given to monitoring and adjustments made to process control. Any substrate change has to be performed carefully, with slowly increasing rates. The resulting methane productivity ($\text{m}^3\text{CH}_4\cdot\text{m}^{-3}\cdot\text{d}^{-1}$), the methane yield ($\text{m}^3\text{CH}_4\cdot\text{kg}^{-1}\text{VS}$), the pH, the volatile solids content (VS) and potential for formation of scum layers have to be monitored and/or controlled more frequently.

2.3 Treatment, storage and usage of digestate

Approximately 20% by volume of the substrate that is fed into a digester breaks down to produce biogas and the remainder (the digestate) passes from the digester into the after storage tank for subsequent use. The total solids content of digestate depends on the digestion process and can range from about 6% to more than 30%. No matter what digestion process is used, the digestate contains the same quantities of macro nutrients (nitrogen, phosphorous and potassium), micro nutrients and trace elements (e.g. boron, magnesium, manganese) as the original feedstock. Digestate is therefore a valuable



Photo 9: Gas tight coverage of a post storage tank for digestate in Sweden. Residual biogas developed from digestate is collected for energy use, while greenhouse gas and ammonia emissions are prevented.

natural fertiliser that returns organic matter and nutrients to the soil.

During the AD process some of the organic nitrogen supplied in the substrates is converted into ammonium. As a result the nitrogen in the digestate, when compared with the feedstock, is more readily available to crops as a fertiliser. However, higher ammonia concentrations have potential to create higher ammonia emissions to atmosphere. In consequence digestate storage tanks with gas tight covers (Photo 9) not only capture fugitive losses of methane, reducing greenhouse gas emissions but also fulfil the additional purposes of conserving the ammonium and preventing the escape of odours. The additional biogas production, collected from digestate storage tanks, usually pays back the investments for covers within a short period of time.

Provided that volatile solids are almost completely broken down (>90%) during digestion, storage of digestate in stores without covers (Photo 10) results in very little fugitive losses of methane. However, these open type stores should be covered in a layer of clay pebbles or similar material to prevent ammonia losses to atmosphere, conserve the nitrogen and optimise the monetary value of the nutrients. The degree of completion of degradation must be monitored by periodic residual fermentation



potential tests of the stored digestates.

In most cases the digestate can be directly applied to nearby agricultural land. It should be applied at root level or injected to minimise the risks of ammonia, and to some extent nitrous oxide escape to the atmosphere. Splash plate spreaders should not be used. Rates of application, as with any fertiliser, must be matched to crop need (see Lukehurst et al., (2010) for further details on the management, the storage and use of digestate as a biofertiliser). If sufficient land area is not available, digestates may have to be pre-treated (e.g. sludge separation, NH_3 -separation, dewatering) before further use. Solid fractions are often separated from the digestate before they undergo further composting. Typically nitrogen is associated with the liquid element while phosphorous is associated with the fibrous element. In inland areas, where phosphorous is the rate limiting nutrient for eutrophication, separation of digestate allows the phosphorous to be exported in the form of fibres, while the nitrogen may be applied locally on the land. The separated liquid fraction of the digestate is in some cases partly re-circulated for substrate homogenisation.

2.4 Treatment, storage and use of biogas

Biogas collected from crop digestion may be used directly in a gas boiler for heating or burned in an engine to produce combined heat and power (CHP). In CHP units roughly two-thirds of the energy contained in biogas is transformed into heat, so continuous heat consumption must be assured year round. This is not always possible as heat may not be required in summer in rural towns. Utilisation and sale of produced thermal energy is essential to the business model of a biogas CHP facility. Markets for heat such as breweries, swimming pools or greenhouses should be exploited to the greatest extent possible.

Upgrading of biogas to natural gas quality (pure methane, termed biomethane), allows better use of the energy content of biogas. Biomethane may be used as a transport fuel or injected to the natural gas grid for use off site (Smyth et al., 2010; Petersson and Wellinger, 2009). This is increasingly the end use of choice of plant developers.

Photo 10: Open lagoon storage for completely digested maize and grass silage; this is applicable where there is no longer any possibility for methane production from the digestate

3. Application of crop digestion

3.1 Co-digestion and mono-digestion of crops

It is common practice for crops to be co-digested with manure or other liquid substrates to promote homogenous or stable conditions within the digesters. This allows a process similar to wet digestion, whereby the dry solids content within the digester is below 10% which enables effective reactor mixing. In most cases mechanical stirrers are used to mix the digester contents.

Mono-digestion of crops is not as common. Recirculation of digestate is required in such digesting systems in order to maintain homogenous and well buffered digester conditions. However some digestion systems allow feedstocks with dry solids content well in excess of 10%. A typical practical example of full scale dry digestion is described below.

Typically two-step, stirred tank, serial reactor designs are applied in most digestion plants (Figure 3b; Photos 11 and 12). The second digester is often combined with a membrane type gas holder. Single step digesters are rarely used.

Anaerobic digestion of crops requires, in most cases, prolonged hydraulic residence times from several weeks to months. Either mesophilic or thermophilic temperatures can be applied in anaerobic digestion of crops.



Photo 11: General view of a 2-step crop digestion plant with digester 1 (right) and combined gas collector and digester 2 (left)



Photo 12: General view of a 2-step crop digestion plant with digester 1 and digester 2 combined with membrane gas collector. The silage clamp can be seen on the right.

Complete biomass degradation with high gas yields and minimal residual gas potential of the digestate is essential in terms of economy, sustainability and minimisation of greenhouse gas emissions. Volatile solids degradation efficiencies of 80–90% should be realised in order to achieve efficient substrate use and minimal emissions (CH_4 , NH_3) from the digestate.

3.2 An example of mono-digestion of crops

The agricultural plant selected as a typical example (Photo 13), was one of the first, using solely solid crop substrates, in this case maize and grass silage (Figure 4). The facility is in Austria. The crops are harvested from

Tab. 2: Operational parameters of a representative plant, digesting crops only. The installed electrical power is 500 kW_e.

Input of maize whole crop silage	5,940 t. year ⁻¹
Input of grass silage	2,181 t. year ⁻¹
Input of clover silage	1,374 t. year ⁻¹
Total feedstock	9,495 t. year ⁻¹
Biogas production	1.88 Mm ³ . year ⁻¹ (198 m ³ .t ⁻¹)
Production of electrical energy	4,153 MWh. year ⁻¹ (38% η_e)
Production of thermal energy	4,220 MWh. year ⁻¹ (39% η_t)
Own electrical consumption	161 MWh. year ⁻¹ (4% parasitic demand)
Own thermal consumption	701 MWh. year ⁻¹ (17% parasitic demand)
Sale of electricity	3,992 MWh. year ⁻¹
Sale of thermal energy	1,697 MWh. year ⁻¹ (48% of available)



Photo 13: General view of a two-step, 500 kW_e only energy crop digestion plant with digester 1 and dosing unit (center), digester 2 with integrated gas holder (left), silage clamps (background) and storage lagoon for the digestate (foreground right).

about 300 ha and ensiled for year round utilisation. The silage clamp capacity is about 15,000 m³ (50m³ of silage capacity is provided per hectare).

Approximately 25 tons of substrate per day are fed (Table 2; Figure 5) into the first of two serial digesters. Both digesters are built from concrete, each one with a capacity of 1,500 m³ (10m³ of digester is provided per hectare). The two digesters are operated at 43°C. Stirring of the digesters is effected by two horizontally arranged, slowly rotating paddles each one requiring 5.5 kW_e (10 kW_e.h.t⁻¹ of mixing is provided) for operation.

The digestate leaving the second digester is separated by a decanter centrifuge. Part of the liquid fraction is used for dilution and homogenisation of the substrate; this is affected by keeping the DS content below 10 % in the first digester. The solid fraction and the surplus liquid digestate are used as valuable phosphate and nitrogen fertilizer on nearby fields.

The biogas produced is collected in a 300 m³ membrane gas holder integrated into the second digester. After cleaning, the biogas is used as a fuel for power and heat production and sold to the public power grid and the local district heating network. Parasitic electrical demand is of the order of 4% of that produced. Parasitic thermal demand is of the order of 17% while 48% of the net heat produced is sold (Table 2).

3.3 An example of co-digestion of crops

The agricultural plant selected as a typical practical crop co-digestion example, was one of the earlier applications, built in 2003. The plant (Photo 14) is located on a pig breeding farm in Austria, where the manure (20 m³.day⁻¹) is used as a co-substrate (Table 3) and helps to achieve homogenisation of the solid crop feedstock. The crops consist of maize silage and crushed dry crops, together with minor amounts of residues from vegetable

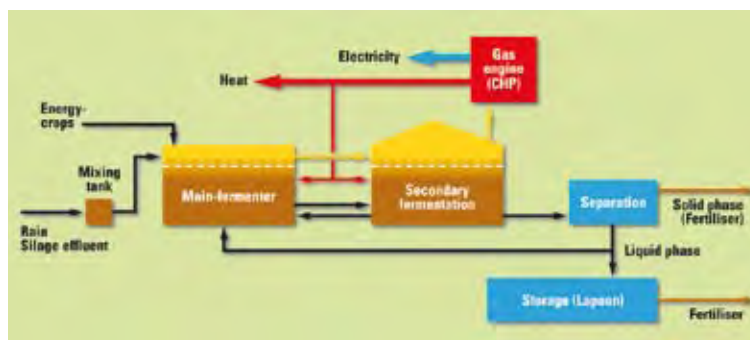

Figure 4: Flow chart of a two step crop digestion plant with 500 kW_e electrical capacity. Solid crops (maize, grass) are used as substrates. Dilution of the substrate to less than 10 % DS is achieved through recycling of liquid digestate and addition of leachate from the silage clamp

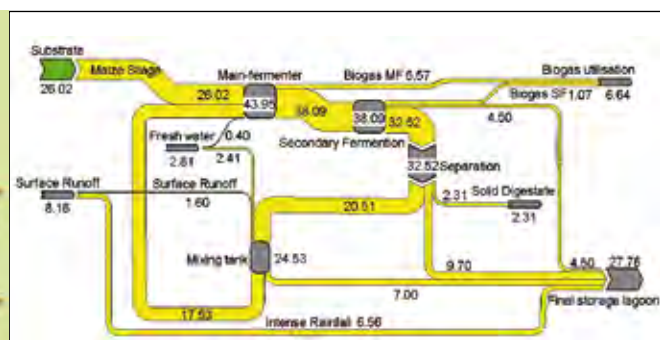

Figure 5: Mass flow diagram from a two-step crop digestion plant of 500 kW_e electrical capacity. The plant uses liquid / solid separation of digestate and recycles the liquid digestate for substrate dilution. All data is given in tonnes / day. (Biogas MF represents biogas from the main digester; biogas SF indicates biogas from the second digester)

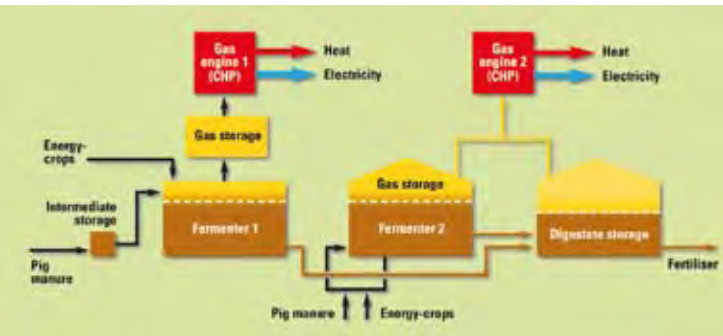

Figure 6: Flow chart of a crop co-digestion plant using two parallel digesters. Solid crops (maize) and vegetable processing by-products are used as substrates. Dilution of the substrates to less than 10 % DS is achieved by adding liquid pig manure and leachate from the silage clamp.

processing. Approximately $11,000 \text{ t}\cdot\text{year}^{-1}$ of crops are processed together with $7,300 \text{ t}\cdot\text{year}^{-1}$ of manure and leachate from the silage clamps. A flow sheet of the installation is shown in Figure 6.

Two parallel digesters are fed hourly through an automatic dosing unit. The reactors are operated at 39°C with a 77 day residence time; this corresponds to a volumetric loading rate of $4.4 \text{ kg VS}\cdot\text{m}^{-3}\cdot\text{d}^{-1}$. Reactor mixing is performed by mechanical stirrers. Dilution of the substrate mixture to a DS content below 10 % is required for sufficient reactor mixing.

The plant produces about $4,020,000 \text{ m}^3$ of biogas annually (Table 3). Hydrogen sulphide is removed by addition of air into the head space of the digesters. The biogas is collected in an integrated gas holder inside the second digester, as well as in an external dry gas holder. Power and heat are produced in two CHP units with a

Tab. 3: Operational parameters of a representative crop co-digestion plant of 1 MW electrical capacity, using 2 parallel digesters

Input crops	$11,000 \text{ t}\cdot\text{year}^{-1}$
Input manure + leachate from silage	$7,300 \text{ t}\cdot\text{year}^{-1}$
Total feedstock	$18,300 \text{ t}\cdot\text{year}^{-1}$
Silage clamp capacity	$9,000 \text{ m}^3 (0.82 \text{ m}^3\cdot\text{t}^{-1})$
Volume digester 1	$2,000 \text{ m}^3$
Volume digester 2	$1,850 \text{ m}^3$
Total volume of digesters	$3,850 \text{ m}^3 (0.21 \text{ m}^3\cdot\text{t}^{-1}\cdot\text{year}^{-1})$
Substrate dosage / day - Digester 1 / 2	$25 \text{ m}^3 / 20 \text{ m}^3$
Biogas production	$4.02 \text{ Mm}^3\cdot\text{year}^{-1} (220 \text{ m}^3\cdot\text{t}^{-1})$
Production of electrical energy	$8,030 \text{ MWh}\cdot\text{year}^{-1}$
Production of thermal energy	$8,223 \text{ MWh}\cdot\text{year}^{-1}$
Own electrical energy consumption	$562 \text{ MWh}\cdot\text{year}^{-1}$
Own thermal energy consumption	$50 \text{ MWh}\cdot\text{year}^{-1}$
Thermal consumption pig breeding	$1,000 \text{ MWh}\cdot\text{year}^{-1}$
Sale of electrical energy	$7,468 \text{ MWh}\cdot\text{year}^{-1}$
Sale of thermal energy	$1,600 \text{ MWh}\cdot\text{year}^{-1}$
Volume digestate storage tank covered	$2,000 \text{ m}^3$
Volume digestate storage tank uncovered	$3,800 \text{ m}^3$
Total digestate storage	$5,800 \text{ m}^3 (0.32 \text{ m}^3\cdot\text{t}^{-1}\cdot\text{year}^{-1})$

total capacity of 1 MW_e and 1.034 MW_{th} . The electricity is fed to the national power grid and the heat is used in a local district heating network.

The digestate is collected in a gas tight final storage tank, before use as fertiliser in the neighbourhood of the farm. Additionally the biogas collected from the final digestate storage tank is used in the two CHP units.

As an annual mean value, it is possible to achieve 98 % of the theoretical capacity of the CHP. The substrate

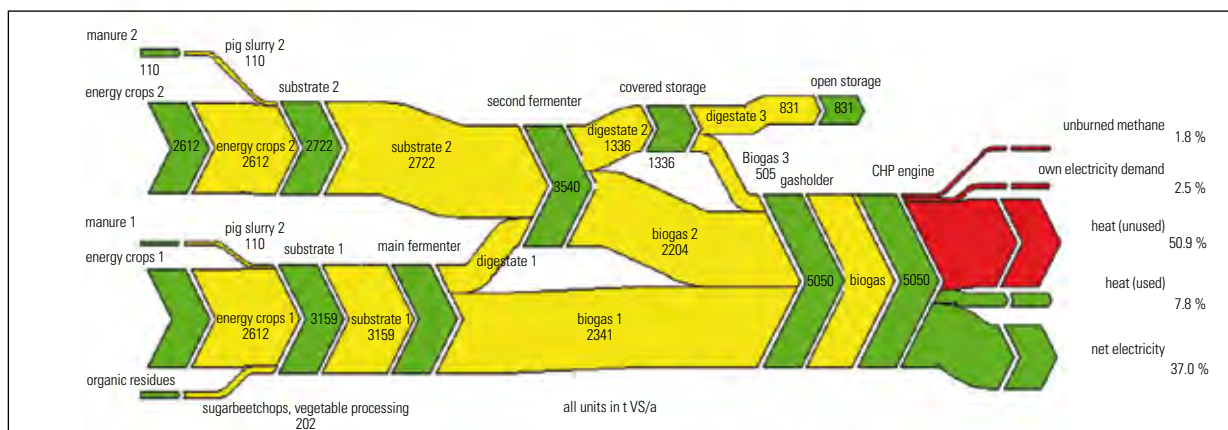

Figure 7: Mass flow and energy efficiency of a crop co-digestion plant, showing a net electrical efficiency of 37 % and a high proportion of unused heat (50.9 %). Just 7.8 % of the overall energy is used as heat. Methane loss in the CHP is 1.8 %. Parasitic electricity demand is 2.5 % of energy in the biogas.



Photo 14 : General view of a 1 MW_e crop co-digestion plant using two parallel digesters (left background) and a covered final digestate storage tank (centre foreground). Gas storage is integrated in digester 2 (background) and in the final storage tank (foreground), further storage capacity is provided in a dry gas storage tank (background right).

mass flow and the energy efficiency of the biogas plant are shown in Figure 7. Of the energy content in the original substrate, 37 % is converted into electricity. Electricity demand on site is 7% of the produced electricity. Only 7.8 % of the energy content of the substrate is used as heat. Heat loss equates to 50.9 % of the substrate energy. Methane loss in the CHP facility is 1.8 %.

3.4 An example of continuous dry digestion of crops

The agricultural plant selected as a typical example (Photo 15), was one of the first continuously operated dry digestion plants, treating solid crop substrates with high solids concentration in the digester. This German facility is operated by four farmers who together own 355 ha arable land and 25 ha pasture land for crop production.



Photo 15: Dry continuous digestion

The process is a vertical plug-flow digester without any stirring device (Figure 3d). The ensiled crops are mixed with digestate and the mixture is pumped to the top of the digester (Figure 8). The digester consists of two zones: an upper zone where intensive fermentation takes place by constantly recycling the digestate and a second zone for post-fermentation, where digestate is allowed to ferment without an extra feeding. The digesting material flows from the top of the digester to the conical bottom by gravity only. The biogas is captured at the top of the digester and flows to an external dry gas holder. The process is operated at 54°C with a 29 day residence time, corresponding to a volumetric loading rate of 9.7 kg VS.m⁻³.d⁻¹. The substrate mixture has a dry solids content of around 30 %, while the digestate has a dry solids con-

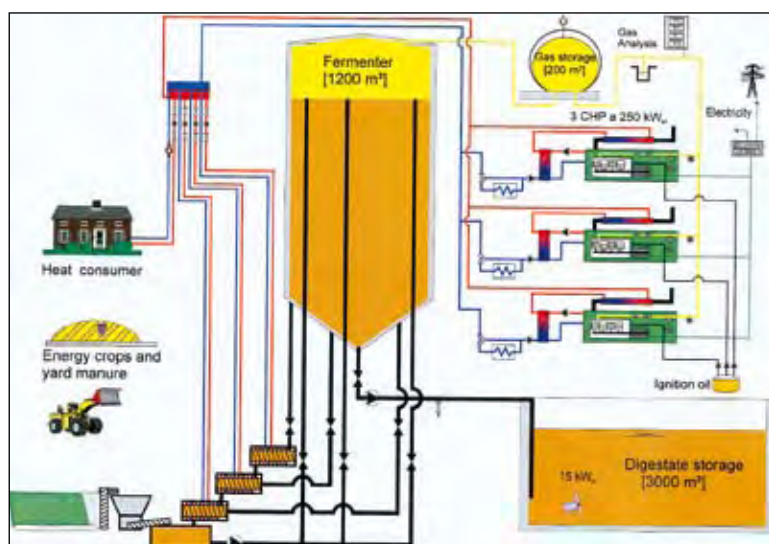

Figure 8: Flow chart of the dry continuous digestion of crop process

Tab. 4: Operational parameters of a continuously operated dry-digestion plant with an electrical capacity of 500 kW_e

Input of whole crop maize silage	5,700 t . year ⁻¹
Input of total plant cereal silage	2,760 t . year ⁻¹
Input of sunflower silage	1,490 t . year ⁻¹
Input of grass silage	720 t . year ⁻¹
Input of yard manure	830 t . year ⁻¹
Total feedstock	11,500 t . year ⁻¹
Potential biogas production	2.54 Mm ³ . year ⁻¹ (221m ³ .t ⁻¹)
Production of electrical energy	4,140 MWh .year ⁻¹
Production of thermal energy	4,340 MWh .year ⁻¹
Own electrical consumption	350 MWh .year ⁻¹ (8.5% electrical parasitic demand)
Own thermal consumption	275 MWh .year ⁻¹ (6.3% thermal parasitic demand)

tent of approximately 16 %. The specific biogas productivity is 5.8 m^3 per m^3 reactor volume per day¹.

The $1,200 \text{ m}^3$ digester has a height of 25 m and a diameter of 8.5 m. For power and heat production three CHP units with a total capacity of 750 kW_e and 780 kW_{th} are installed. Due to higher feed-in tariffs at capacities below 500 kW_e , the electrical output is now limited to a maximum of 500 kW_e . Therefore only 60 % of the total digester volume is used and only two CHP units are regularly running. Electricity is sold to the public grid at a fixed rate of $17.9 \text{ € c} \cdot \text{kW}_e \cdot \text{h}^{-1}$, in accordance with the German Renewable Energy Act (EEG). Heat is used in a district heating network for heating houses and for drying purposes. The plant began operation at the end of 2006 and treats 11,500 tons substrate per year (Table 4). As an annual mean value, 97 % of the theoretical capacity of two CHP units is achieved.

The vertical design makes high solids concentrations feasible without the need for mixing. The down-flow operation avoids phase separation and prevents the formation of a scum layer. The vertical design also minimizes the surface area requirement and facilitates the integration of the plant on the farm site.

3.5 An example of crop conversion to gaseous biofuel

This Austrian facility is based on a group of farmers who together farm 45 ha of permanent pastureland. This land was previously used for dairy farming but is now used for grass silage production as a feedstock for biomethane production. Initially the farmers purchased a further 30 ha of grass silage from neighbouring farmers. As such the facility is fed by grass from 75 ha which comprises 98% of the feedstock; 2% of the feedstock is maize

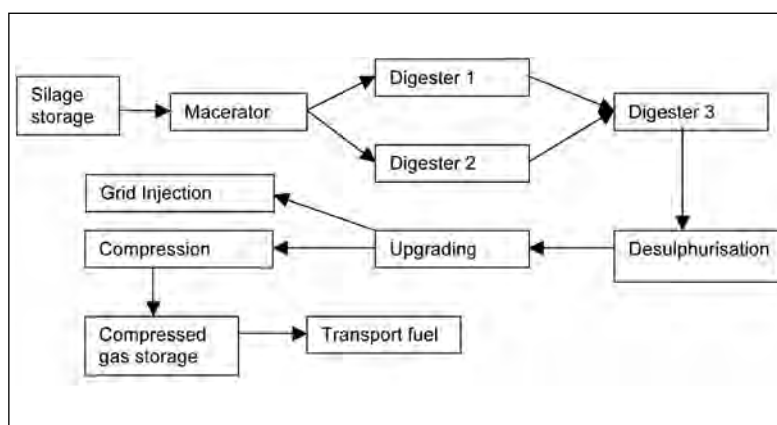

Figure 9: Flow chart of plant system

silage. The grass is cut 3 to 4 times per year and left to wilt in the field resulting in a dry solids content of 40%. Grass yields vary between 11 and 13 t DS per hectare. Storage capacity of 3000 m^3 is provided in silage clamps. The digesters are constructed of reinforced concrete and are predominately under ground. When visited, the plant was undergoing conversion from a smaller facility (75ha) producing CHP to a larger system (150 ha) producing biomethane for transport fuel. The larger system is described below. Figure 9 details the flow through the system. The silage is macerated and fed in parallel to two digesters of capacity of approximately 900 m^3 each and heated to 43°C . The digestate from the digesters flows to digester 3 (2200 m^3 capacity). Gas is stored over the third digester.

Mixing is a critical design issue for grass due to its

Tab. 5: Operational parameters of a representative grass to gas facility

Grass silage yield (150 ha @ $11 \text{ tDS} \cdot \text{ha}^{-1} \cdot \text{year}^{-1}$)	$1650 \text{ t DS} \cdot \text{year}^{-1}$
Mass of silage per annum (@40% dry solids)	$4125 \text{ t} \cdot \text{year}^{-1}$
Capacity of silage clamps	3000 m^3 ($20 \text{ m}^3 \cdot \text{ha}^{-1} \cdot \text{year}^{-1}$)
Storage of silage (density of silage $500 \text{ kg} \cdot \text{m}^{-3}$)	4.4 months
Volatile solids (92% of DS)	$1518 \text{ t VS} \cdot \text{year}^{-1}$
Combined Fermenter volume	4000 m^3 ($0.96 \text{ m}^3 \cdot \text{t}^{-1} \cdot \text{year}^{-1}$)
Loading Rate	$1.04 \text{ kg VS} \cdot \text{m}^{-3} \cdot \text{day}^{-1}$
Methane production ($340 \text{ m}^3 \text{ CH}_4 \cdot \text{t}^{-1} \text{ VS}$)	$516,120 \text{ m}_n^3 \cdot \text{year}^{-1}$
Biogas production (@55% CH_4)	$938,400 \text{ m}_n^3 \cdot \text{year}^{-1}$ ($227 \text{ m}_n^3 \cdot \text{t}^{-1}$)
Biomethane production (@98% CH_4 ; 5% of CH_4 to off gas)	$500,350 \text{ m}_n^3 \cdot \text{year}^{-1}$
Biomethane production	$57 \text{ m}_n^3 \cdot \text{hour}^{-1}$
Biomethane storage (1920 Litres @ 300 bar = 576 Nm^3)	10 hours



Photo 16: Storage cylinders for compressed biomethane and compressed biomethane dispenser on farm

propensity to float. A number of mixing systems are employed including vertical and inclined agitators as well as recirculation of biogas through the digesters. Liquid digestate is recirculated around the digesters. This helps to maintain a low solids content and also improves the digestion process. Excess digestate is removed from digester 3 and is applied to the land as a fertilizer. In essence digester 3 is oversized to allow for storage of digestate. Once the spreading season starts the level in digester 3 is reduced considerably. The calculated organic loading rate ($1.1 \text{ kg VS}\cdot\text{m}^{-3}\cdot\text{day}^{-1}$) is as such conservative.

Oxygen is added to digester 3 to remove hydrogen sulphide (H_2S). Oxygen is added in place of air to reduce the diluting effects of nitrogen. Pressure swing adsorption is used to upgrade the gas to 98% methane content. Similar volumes of biomethane (dominated by CH_4) and off-gas (dominated by CO_2) are produced. The off-gas is fed to a low calorific-optimised Micro Gas Turbine. Sufficient biomethane is produced to fuel 220 cars per year ($15,000 \text{ km}\cdot\text{year}^{-1}$ at a fuel efficiency of $15\text{m}_n^3\cdot 100\text{km}^{-1}$). This is more than the local demand. Thus some of the biomethane is injected to the natural gas grid. The remaining biomethane is compressed to 300 bar and stored in 24 gas storage cylinders (Photo 16) each 2 m long with a diameter of 220 mm. The storage capacity is 1920 litres, equivalent to 576 m_n^3 of biomethane. The biomethane is dispensed for transport fuel on a self service basis through an on-site dispensing system (Photo 16).

4. Experience in crop digestion

4.1 Number of crop digestion plants in different countries

Sweden, Finland and France do not have any dedicated crop digesters but co-digestion does take place at a few facilities. Switzerland and Norway do not offer tariffs for crops and do not have any crop digesters. Denmark focuses very much on animal slurries and waste while the United Kingdom focuses on waste. Other IEA Task 37 countries such as Ireland and Turkey are at an embryonic stage of anaerobic digestion and do not have crop digesters.

The crop digestion industry is dominated by Germany (ca. 5700 digesters) and Austria (290 digesters); the industry in these countries is expanded upon below.

4.2 Full-scale crop digestion plants in Austria

Long term monitoring of full scale crop digesters give an insight to process performance. In an Austrian project, a sample of 41 digestion plants was monitored over an extended time period. A broad variety of substrates was used for biogas production (Figure 10). Crops comprised between 10 and 100 % of feedstock. The share of manure varied between 5 and 95 %; two plants used no manure at all. Agricultural residues and by-products were also used in relatively minor amounts (5–10 %). Bio-waste from source separated collection (mainly kitchen and restaurant waste) was digested in 11 plants (15–25 % of

Tab. 6: Typical long term operational data as derived from 41 full-scale crop digestion plants in Austria (Laaber et al., 2005).

Parameter	Unit	Median ¹	Min.	Max.
Substrate processing capacity	t . d ⁻¹	13.2	0.8	58.9
Hydraulic retention time ²	D	133	44	483
Loading rate (VS)	kg . m ⁻³ .d ⁻¹	3.5	1	8
Amount of VS fed into digester	t . d ⁻¹	2.3	0.3	13.8
Amount of biogas produced	m _n ³ . d ⁻¹	1,461	232	8,876
Biogas yield referred to VS	m _n ³ . kg ⁻¹	0.673	0.423	1.018
Biogas productivity	m _n ³ . m ⁻³ .d ⁻¹	0.89	0.24	2.30
Methane concentration	% (v/v)	54.8	49.7	67.0
Methane yield referred to VS	m _n ³ . kg ⁻¹ VS	0.362	0.267	0.567
Degradation of VS	%	82.8	61.5	96.8
Availability of CHP	%	83.3	35.7	98.2
CHP operational hours per year	hours	7,300	3,100	8,600
Electricity utilization efficiency	%	31.3	20.7	39.2
Thermal utilization efficiency	%	16.5	0.0	42.6
Overall efficiency of biogas energy ³ use	%	47.3	30.5	72.7

substrate) and one plant was operated exclusively with bio-waste. The following operating parameters are highlighted (Table 6):

- The processing capacity of fresh substrate varied in the range 1–59 t/d.
- The mean biogas yield was 0.67 m_n³ kg⁻¹ VS;
- The mean CH₄ content was 55 %;
- The mean methane yield was 0.362 m_n³ kg⁻¹ VS;
- The VS degradation efficiency had a mean value of 82.8%;
- Mean electrical efficiency was 31.3%;
- Lack of heat customers meant an overall average of only 47.3% of produced heat was used.

An even distribution between one and two step digester configurations was observed. In 15 % of cases three

step digesters were used. Nearly 90 % of all plants are operated at mesophilic temperatures (30–42°C); only 10 % of the new plants use thermophilic temperatures (50–55°C).

4.3 Full-scale crop digestion plants in Germany

Weiland evaluated German biogas plants in 2004 and 2009 (Weiland, 2004; FNR, 2009). Most plants used manure based substrate mixtures, with a range of crops including maize, grass and cereals. Food and vegetable wastes, potato processing residues, whey and fat trap contents were also used as co-substrates with manure. In the 2004 study manure was the dominant substrate (75–100 % share) in nearly 50 % of the plants considered. About 83 % of the new German agricultural biogas plants operate with a mixture of crops and manure; 15 % use crops only and just 2 % were operated with manure only. The 2004 study indicated that nearly 90 % of all new German plants were operated with wet digestion technology while the remainder use dry-digestion. The total solids content of the substrates used in wet fermentation systems was between 13–30 % DS. In the case of dry-digestion the input DS content was above 30 %. The final digestate DS content is always below 10 %, which facilitates effective homogenisation and application of the digestate as fertilizer.

With wet digestion systems, the loading rate varied between 1.2 – 4.3 kg VS.m⁻³. d⁻¹. The majority of digesters had a residence time of between 50 and 150 days; 10 % of digesters used more than 200 days. Residence times of below 50 days were only realised when the share of crops was below 20%. In mono-digestion of crops the residence time was always above 100 days (Weiland, 2004).

The CH₄ content in the biogas was in the range 50 to 55 % for 55 % of the plants and 55 to 65% for 45 % of the plants considered. Methane productivity of 0.7 – 0.9 m_n³.m⁻³.d⁻¹ was typical for one-third of plants. Nevertheless the methane productivity varied in the broad range of 0.5 – 1.1 m_n³.m⁻³.d⁻¹, with only a few plants achieving a productivity of more

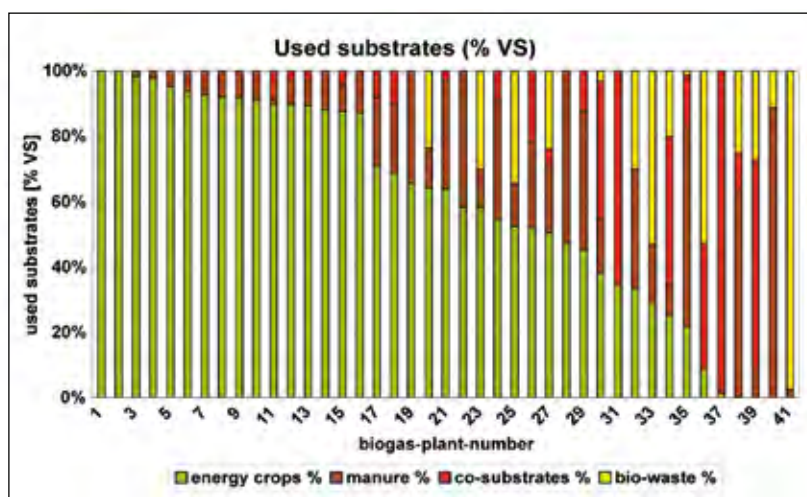

Figure 10: Distribution of crops, manure, co-substrates and bio-wastes as used in a sample of 41 Austrian full scale crop digestion plants (Laaber et al, 2005)

¹ Instead of average values the statistic term median is used in calculations (weighted mean value)

² Mass of substrate (t.d⁻¹) instead of (m³.d⁻¹) is referred to the reactor volume (m³)

³ Net calorific value

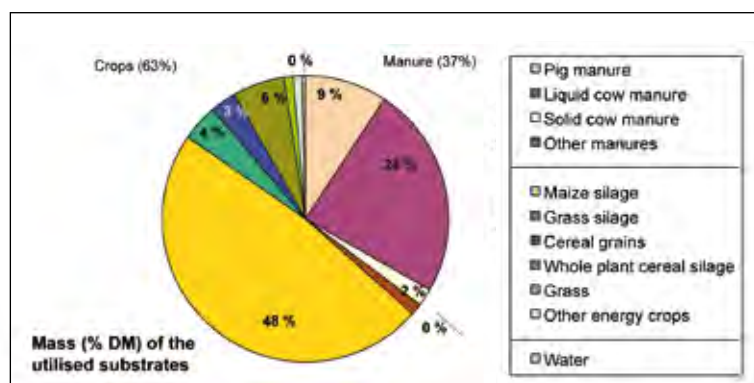
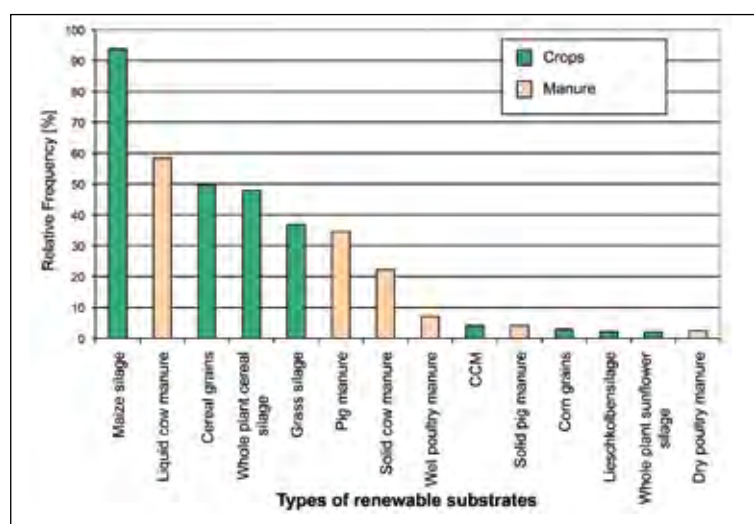

Figure 11: Average share of different substrates (%DM) in German biogas plants (FNR, 2009)



CCM is corn cob mix; Lieschkolbensilage is silage of corn cobs and leaves

Figure 12: Frequency of different substrates in German biogas plants (FNR, 2009)

than $1.1 \text{ m}^3 \cdot \text{m}^{-3} \cdot \text{d}^{-1}$. The majority of plants (80 %) found a market for 80 to 95 % of the combined electricity and heat produced, while the remaining only utilised 50 to 80 % of energy produced due to very limited heat utilisation (Weiland, 2004).

The breakdown of substrates in the 2009 study is indicated in Figures 11 and 12 and in Table 7. Maize silage is the dominant crop followed by whole plant cereal silage, grass silage, cereal grain and early rye silage.

Tab. 7: Average, medium and maximum percentage of the five most frequently used substrates in German biogas plants (FNR, 2009)

	Maize silage	Cereal Grains	Grass silage	Whole crop cereal silage	Early rye Silage
Average mass percentage of total substrate	50.0	3.1	10.5	10.7	9.8
Minimum (%)	7.0	0.25	0.53	0.29	0.36
Maximum (%)	98.3	23.5	51.5	29.3	53.5

5 Significance and potential of crop digestion

5.1 Crop digestion and agricultural sustainability

Crop digestion leads to increased activity in the agricultural sector by increasing demand for locally grown biomass. Furthermore, the cultivation of crops promotes investment in the rural economy and the production of diverse sustainable rural employment. Currently, most crops are grown as intensive monocultures. Annual monocultures are often associated with high rates of soil erosion. Some crops, like maize, deplete soil nutrients more rapidly than others, and might require significant levels of agrochemicals (fertilizer, pesticides); this can be minimised through recycling of digestate. High yield crops in Continental Europe may also depend on irrigation. The risks of water depletion and of pollution may occur. Nevertheless, if sustainability criteria are followed, (Cramer et al., 2006) the use of crops will lead to a reduction in GHG emissions through replacement of fossil fuels.

No single crop can cover all specific requirements of the various local conditions. Comprehensive investigations for the selection of optimised plantation systems for different habitats have been started in countries such as Germany, The Netherlands and Austria (FNR, 2008). Results so far indicate the influence of soil quality, climate, water availability, crop rotation and last, but not least, the time of harvesting on biomass yield, methane production potential and consequently the overall economic viability.

5.2 Biogas yield per hectare of crops

Most crops have been found to have similar methane yields per t of VS (Table 1). On the other hand, different crops give different biomass yields per hectare. Consequently, from an agricultural point of view a better measure to compare overall yield, is the energy yield per hectare of cultivated land (Table 8).

Due to its high yields (potentially up to $30 \text{ t DS} \cdot \text{ha}^{-1}$), maize is widely used in continental Europe as a substrate in many crop digestion facilities.

Root crops like beets (up to 20 t DS.ha⁻¹.year⁻¹) and potatoes (11 to 50 t DS.ha⁻¹.year⁻¹) can also achieve high yields per hectare, but are comparably seldom used for anaerobic digestion, mainly due to operational drawbacks associated with soil contamination and hence sand accumulation inside the digesters.

Grass (up to 15 t DS.ha⁻¹.year⁻¹) and clover (up to 19 t DS.ha⁻¹.year⁻¹) result in medium energy yields per hectare, but are commonly used on account of their wide availability, the fact that they are perennial and because they need relatively low level input during culti-

vation (Murphy and Power, 2009). Low input, high diversity mixtures of native grassland perennials are also associated with improved soil and water quality. In the long term, perennials may even outnumber annual monocultures in terms of biomass yield per hectare. Grasslands are net sequesters of carbon, can be produced on marginal lands and neither displace food production nor cause loss of biodiversity (Tilman et al, 2006; Korres et al. 2010).

Other grains are needed for crop rotation (e.g. rye), but they give lower biomass yield per hectare, compared for example to maize or beets.

As a consequence crops should be carefully selected, depending on local climate conditions, availability of irrigation water, resistance to diseases, and last but not least, biomass yield per hectare.

Tab. 8: Range of estimated crop, methane and energy yields per hectare

Crop	Crop yield ¹⁾ t DS. ha ⁻¹	Measured methane yield ²⁾ m ³ . t ⁻¹ VS	Calculated methane yield ³⁾ m ³ . ha ⁻¹
Maize (whole crop)	9–30	205–450	1,660–12,150
Wheat (grain)	3.6–11.75	384–426	1,244–4,505
Oats (grain)	4.1–12.4	250–365	922–4,073
Rye (grain)	2.1	283–492	535–930
Barley	3.6–4.1	353–658	1,144–2,428
Triticale	3.3–11.9	337–555	1,000–5,944
Sorghum	8–25	295–372	2,124–8,370
Grass	10–15	298–467	2,682–6,305
Red clover	5–19	300–350	1,350–5,985
Alfalfa	7.5–16.5	340–500	2,295–7,425
Sudan grass	10–20	213–303	1,917–5,454
Reed Canary Grass	5–11	340–430	1,530–4,257
Hemp	8–16	355–409	2,556–5,890
Flax	5.5–12.5	212	1,049–2,385
Nettle	5.6–10	120–420	605–3,780
Ryegrass	7.4–15	390–410	2,597– 5,535
Miscanthus	8–25	179–218	1,289–4,905
Sunflower	6–8	154–400	832–2,880
Oilseed rape	2.5–7.8	240–340	540–2,387
Jerusalem artichoke	9–16	300–370	2,430–5,328
Peas	3.7–4.7	390	1,299–1,650
Rhubarb	2–4	320–490	576–1,764
Turnip	5–7.5	314	1,413–2,120
Kale	6–45	240–334	1,296–13,527
Potatoes	10.7–50	276–400	2,658–18,000
Sugar beet	9.2–18.4	236–381	1,954–6,309
Fodder beet	11.2–20.8	420–500	4,233–9,360

5.3 Net energy yield per hectare of crops

High net energy yield per hectare is an indispensable prerequisite for good economic operation of a crop digestion plant. This includes high biomass yields and low energy requirement for plant cultivation, harvesting and processing.

For crop production, energy is required for ploughing, seedbed cultivation, fertilising, pesticide and herbicide application, harvest and transport (Table 9). Furthermore, considerable energy is required for the production of fertilisers, pesticides and herbicides. From practical experience, on average, about 50 % of the total energy requirement is associated with fertiliser production; smaller amounts are required for machinery (22 %), transport fuel (15 %) and pesticides (13 %). Besides crop production, further energy is required as process energy in the digestion process, for digestate post-treatment, transportation, and eventually for biogas upgrading.

Tab. 9: Estimated required energy input per hectare for the cultivation of different plants

Crop	Energy requirement (GJ . ha ⁻¹)
Potatoes	24.2
Beets	16.8–23.9
Wheat, barley, maize	14.5–19.1
Grass	12.73–20.6

¹⁾ Statistics Handbook Austria 2005. Statistik Austria, Vienna Austria, Cropgen, 2011 and KTBL, 2005.

²⁾ Data from Cropgen, 2011; from Murphy and Power, 2009; Korres et al. 2010; and Smyth et al., 2009.

³⁾ Assuming 90% volatile solid content

Tab. 10: Rough calculation of net energy yield and output / input ratios for selected examples of crops

	Maize	Potatoes	Fodder beet	Grass	Oilseed rape	Rye
Methane yield $\text{m}^3 \cdot \text{ha}^{-1}$	5,748	9,235	6,624	4,303	1,344	732
GJ $\cdot \text{ha}^{-1}$	217	349	250	163	51	28
Process energy demand for digestion GJ $\cdot \text{ha}^{-1}$	33	52	38	24	8	4
Energy requirement in cropping GJ $\cdot \text{ha}^{-1}$	17	24	20	17	17	17
Total energy requirement GJ $\cdot \text{ha}^{-1}$	50	76	58	41	25	21
Net energy yield GJ $\cdot \text{ha}^{-1}$	167	273	192	122	26	7
Output (GJ $\cdot \text{ha}^{-1}$) Input (tot. Energy)	4.3	4.6	4.3	4.0	2.0	1.3

For a rough calculation of the net energy yield in crop digestion, the mean values (crop yield $\text{t DS} \cdot \text{ha}^{-1} * 0.9 \text{ VS} \cdot \text{DS}^{-1} * \text{methane yield } \text{m}^3 \cdot \text{t}^{-1} \text{ VS}$) for maize, potatoes, fodder beet, grass, oilseed rape and rye can be used as examples (Table 10). These crops cover the range from highest (about $9,000 \text{ m}^3 \text{ CH}_4 \cdot \text{ha}^{-1}$) to lowest (below $1,000 \text{ m}^3 \text{ CH}_4 \cdot \text{ha}^{-1}$).

For comparison purposes it is assumed that the parasitic energy demand of the digestion process is 15 % of the energy produced. The energy demand (both for process and crop production) are subtracted from the primary methane yields to give the net energy produced per hectare. This varies between 7 – 273 GJ per hectare. The respective energy output / input ratios vary between 1.3 (rye) and 4.6 (potatoes).

Tab. 11: Gross and net energy per hectare associated with first generation biofuel systems from Smyth et al (2009)

	Gross Energy GJ $\cdot \text{ha}^{-1} \text{ year}^{-1}$	Net Energy GJ $\cdot \text{ha}^{-1} \text{ year}^{-1}$
Rape seed biodiesel (not considering by-products)	46	25
Optimised wheat ethanol (use of straw for thermal energy and digestion of stillage)	84	43
Palm oil biodiesel	120	74
Sugar cane ethanol	135	120

With the assumptions chosen, positive net energy production is achievable, even in the worst case with poor crop yields (e.g. rye). These values compare very favourably to the gross and net energy return associated with first generation liquid biofuel systems (Table 11). However the overall economic feasibility of the process depends on a high return on energy sales.

5.4 Profitability of crop digestion

From practical experience, financially viable operation of a crop digestion system can only be achieved if high crop and biogas yields can be combined with reasonably low crop costs, low capital and operating costs of the biogas facility and appropriate feed-in tariffs.

On-farm production of crops reduces the cost of substrate. Gate fees for waste-derived co-substrates can be of great benefit for financial feasibility, especially if the co-substrate increases methane yield per unit of feedstock and does not affect the potential for land application of digestate (Smyth et al., 2010). Economic viability must be carefully evaluated at an early stage of a project. Experience would suggest that the sale of heat is paramount to a successful biogas facility based on CHP. The CHP market needs to be assessed and ensured for the duration of the project. For example, a CHP facility in Denmark has over 100 domestic users of thermal energy; these users are contracted to a group distribution scheme. Entry to the scheme involves a nominal charge and an annual payment for thermal energy that is cheaper than the fossil fuel equivalent. However, to leave the scheme a significant financial contribution must be paid.

In facilities where crops are digested financial viability may be difficult to achieve. If it is considered for example that grass costs approximately $\text{€ } 25 \cdot \text{t}^{-1}$ for pit silage and produces about 140 m^3 of biogas (3.00 GJ; $325 \text{ kW}_e @ 40\% \eta_e$) then the feedstock cost is of the order of $\text{€ } c 7.7 \cdot \text{kW}_e \cdot \text{h}^{-1}$. Germany has an advantage in that the NaWaRo bonus gives $\text{€ } c 7 \cdot \text{kW}_e \cdot \text{h}^{-1}$ for crops on top of a basic compensation of $\text{€ } c 9 \cdot \text{kW}_e \cdot \text{h}^{-1}$. Other bonuses also exist, for

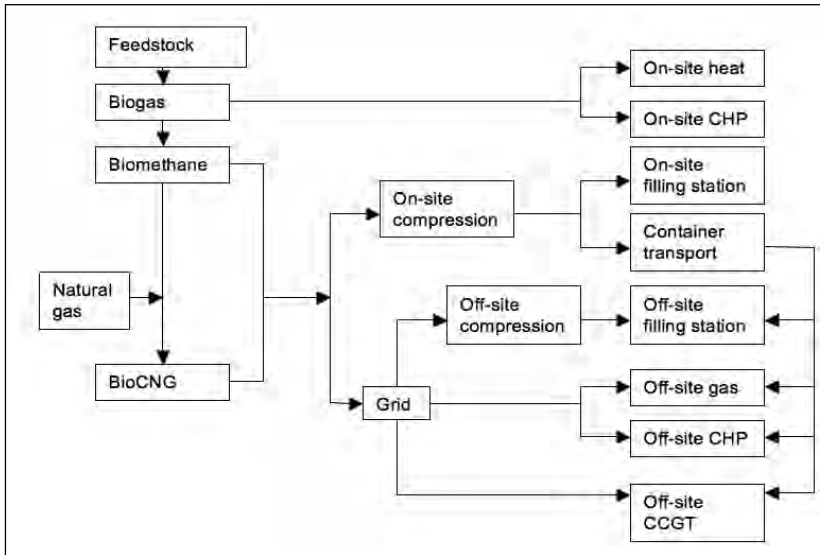

Figure 13: Pathways for use of biogas (Smyth et al. 2010)

example for minimisation of emissions, for grid injection and for use of heat. Typically for crop digestion values in excess of 18 € c . kW_eh⁻¹ are available in Germany. This has allowed an industry of approximately 6000 digesters to develop. In countries which do not have a bonus for crops and have a relatively low feed-in tariff it may be difficult to achieve financial sustainability unless other end uses of the biogas are available (Figure 13).

Grid injection offers significant advantages in optimisation of use of biomethane, in particular in the area of transport. Biomethane when blended with natural gas (termed bioCNG) can provide a low cost transport fuel.

6. Potential for biogas from crops

6.1 Future significance of biogas from biomass

In the early 20th Century many daily necessities such as energy, food, fodder, fertiliser and fibres were derived from agricultural biomass. As the 20th Century progressed, the traditional role of agriculture in energy supply diminished. Petrol and diesel driven vehicles replaced horses. However, with the progressive depletion

of fossil fuels and the requirement for sustainable renewable energy, biomass is again an important raw material. Biomass may be converted to energy through microbial or thermal routes. Microbial conversion, as exemplified by biogas production has several advantages. While thermal energy generation (in particular combustion) destroys the structure of the organic substrate, with a final residue of inorganic ash, bioconversion permits retention of valuable organic structures and the remaining by-products can be advantageously recycled as fertiliser or soil conditioner.

Closed nutrient cycles will become increasingly important especially when considering sustainability as assessed through monitoring greenhouse gas savings of bioenergy systems as compared to the displaced fossil fuel on a whole life cycle basis. Finding the optimal system in terms of crop yield, gross and net energy production per hectare, greenhouse gas reductions and sustainability is still a major challenge for the bioenergy sector.

Land available for crop production is limited. The surface of the earth is mostly covered by oceans (361 . 106 km²). Of the remaining area of 149 . 106 km², 55.7 % are covered by forests, 16.1 % (or 24 . 106 km²) is deemed pastureland and only about 9.4 % (or 14 . 106 km²) is arable land. The world's growing population requires growing quantities of food. This puts pressure on finite agricultural land resources which are required to produce feed for humans and animals, for biomass for industrial use, for alcoholic beverage production, and increasingly for energy production. Advantageously, biogas systems are very flexible. Biogas can also be produced from plants which are not used directly for human consumption; examples include grass. Soils which are marginal and unsuitable for food production can be used for the cultivation of crops.

6.2 Theoretical potential of biogas from crops

The world's annual energy demand stood at about 12,000 Mtoe (503 EJ) in 2010. A rough calculation underlines the potential of crop digestion. Assuming a net biogas energy yield of 150 GJ per hectare per year produced on 10% of all arable land ($1.4 \cdot 10^6 \text{ km}^2$ or $1.4 \cdot 10^8 \text{ ha}$) the potential production is 21 EJ from biomethanation of crops; this is 4.2% of world energy demand. This does not include the contribution from pasture land. In a country such as Ireland where 91% of land is under pasture, grass can make a very significant contribution. Using 2.5% of pastureland a biomethane yield equivalent to 5% renewable energy supply in transport can be supplied (Singh et al., 2010).

7. Conclusions and recommendations

No single technology or renewable energy source could provide all of the world's future energy supply. Anaerobic digestion is under-utilised today in comparison to technologies for producing liquid biofuels, such as ethanol or biodiesel. At issue is the change in energy vector from liquid to gas. Anaerobic digestion is a versatile technology that requires relatively low levels of parasitic energy demand and can use a wide range of crops including lignocellulosic material such as grass. The energy balance of biogas crop systems is shown to be superior to first generation biofuel technologies, for example for ethanol production.

Anaerobic digestion is a technology which can contribute substantially to the production of renewable electricity, renewable heat and renewable transport fuel. Anaerobic digestion allows for sustainable energy supply, rural employment, and security of energy supply. The biogas industry benefits greatly from policy and feed-in tariffs, as demonstrated by the German experience. The existing natural gas grid can provide the means for distribution of biomethane to both individual homes and businesses in many developed countries. The authors conclude that the following are of importance to a successful crop digestion industry:

1: Tariffs for anaerobic digestion of crops

Good feed-in tariffs or other means of financial support are currently essential to achieve a viable financially sustainable biogas industry. The German system offers tariffs for biogas based on a number of criteria, including a bonus if crops are used as a feedstock for biogas production. The high investor security provided by the German feed-in-tariff has been a success, resulting in rapid deployment of renewables, the entrance of many new actors to the market and a subsequent reduction in costs.

2: Alignment of renewable energy and agricultural policy

Family farm incomes have dropped significantly in recent years. Crops can afford a supplemental income for farmers while ensuring the production of sustainable biofuel and the maintenance of an aesthetically attractive countryside. A renewable energy tariff scheme coupled with an agricultural grant scheme provides an incentive to farmers to produce feedstock for biogas facilities and at the same time maintaining development of the rural economy.

3: Targets for biomethane production

For example, the National Biomass Action Plan for Germany has set targets for biomethane supply as a percentage of gas demand of 6% by 2020 and 10% by 2030. Denmark (which had a primary energy demand in 2009 of ca. 850PJ) has set a target of producing 20PJ of biogas by 2020. These targets are of great benefit to the biogas industry.

4: Use of biomethane in transport

Transport fuel may allow a good financial return on biogas and biomethane especially if feed-in tariffs are low. However, a biomethane infrastructure, such as injection points and gas compression stations, has high capital costs especially if a market for gaseous fuel is not in place. It is highly recommended to provide support to initiate a gaseous fuel infrastructure. Connecting biomethane with a captive fleet such as a bus service minimises investments for distribution of the gaseous fuel.

Citations

- BRAUN, R. (2007): *Anaerobic digestion – A multi faceted process for energy, environmental management and rural development*. In: Improvement of crop plants for industrial end users. Ranalli, P. Publisher, Springer.
- BUSWELL, A.M. and HATFIELD, W.D. (1936): *Bulletin No. 32, Anaerobic Fermentations*. State of Illinois, Department of Registration and Education, Division of the State Water Survey, Urbana, Illinois. Available from: <http://www.isws.illinois.edu/pubdoc/B/ISWSB-32.pdf>
- CRAMER, J.; WISSEMA, E.; LAMMERS, E.; DIJK, D.; JAGER, H. VAN BENNEKOM, S.; BREUNESSE, E.; HORSTER, R.; VAN LEENDERS, C.; WOLTERS, W.; KIP, H.; STAM, H. FAAIJ, H., KWANT, K.; HEMELINK, C.; BERGSM, A. G. AND JUNGINGER, M. (2006): *Project group sustainable production of biomass – Criteria for sustainable biomass production*. Available In: http://www.forum-ue.de/bioenergy/txtpdf/project_group_netherlands_criteria_for_biomassproduction_102006bonn.pdf
- CROPPING EUROPEAN PROJECT: <http://www.croppingsoton.ac.uk/> accessed 21 March 2011
- DIRECTIVE 2009/28/EC: *Directive of the European Parliament and of the Council of 23 April 2009 on the promotion of the use of energy from renewable sources and amending and subsequently repealing Directives 2001/77/EC and 2003/30/EC*; available In: <http://www.energy.eu/directives/pro-re.pdf>
- FNR (2008): *Standortangepasste Anbausysteme für Energiepflanzen*. Fachagentur Nachwachsende Rohstoffe e.V. (FNR), Hofplatz 1 D-18276 Gülzow
- FNR (2009): *Biogas-Messprogramm II - 61 Biogasanlagen im Vergleich*. Fachagentur Nachwachsende Rohstoffe e.V. (FNR), Hofplatz 1, D-18276 Gülzow. Website: <http://www.nachwachsenderohstoffe.de/>
- HOLMES, W. (1980): *Grass: Its Production and Utilisation*; British Grassland Society and Blackwell Scientific Publications: Oxford, U.K.
- KORRES, N.E.; SINGH, A.; NIZAMI, A.S. and MURPHY, J.D. (2010): *Is grass biomethane a sustainable transport biofuel?* *Biofuels, Bioproducts, Biorefinery*, 4: 310–325
- KTBL (2005): *Faustzahlen für die Landwirtschaft, 13. Auflage, Kuratorium für Technik und Bauwesen in der Landwirtschaft e.V. (KTBL), KTBL-Schriftenvertrieb im Landwirtschaftsverlag, Münster-Hiltrup, KTBL, Darmstadt, 2005 (ISBN 3-7843-2194-1), 1095 S.*
- KTBL (2009): *Brochure on biogas from energy crops*. In press. KTBL, D-64289 Darmstadt.
- LAABER, M.; KIRCHMAYR, R., MADLENER, R. and BRAUN, R. (2005): *Development of an evaluation system for biogas plants*. 4th Int. Symposium Anaerobic Digestion of Solid Waste, Copenhagen, Denmark.
- LUKEHURST, C.; FROST, P. and AL SEADI, T. (2010): *Utilisation of digestate from biogas plants as biofertiliser*. Available from <http://www.iea-biogas.net/publicationspublic.htm>
- MURPHY, J.D. and POWER, N. (2009): *An argument for using biomethane generated from grass as a biofuel in Ireland*. *Biomass and Bioenergy* 33: 504-512
- NIZAMI, A.S. and MURPHY, J.D. (2010): *What type of digester configurations should be employed to produce biomethane from grass silage?* *Renewable and Sustainable Energy Reviews*, 14: 1558–1568.
- PETERSSON, A. and WELLINGER, A. (2009): *Biogas upgrading technologies – developments and innovations*. Available from <http://www.iea-biogas.net/publicationspublic.htm>
- REINHOLD, F. and NOAK, W. (1956): *Laboratoriumsversuche über die Gasgewinnung aus landwirtschaftlichen Stoffen*. In: Liebmann H (ed) *Gewinnung und Verwertung von Methan aus Klärschlamm und Mist*, R. Oldenbourg, München, Germany
- SMYTH, B.; SMYTH, H. and MURPHY, J.D. (2010): *Can grass biomethane be an economically viable biofuel for the farmer and the consumer?* *Biofuels, Bioproducts, Biorefinery*, 4(5): 519 - 537
- SMYTH, B.; MURPHY, J.D. and O'BRIEN, C. (2009): *What is the energy balance of grass biomethane in Ireland and other temperate northern European climates?* *Renewable and Sustainable Energy Reviews* 13(9): 2349-2360
- SINGH, A.; SMYTH, B.M. and MURPHY, J.D. (2010): *A biofuel strategy for Ireland with an emphasis on production of biomethane and minimization of land take*. *Renewable and Sustainable Energy Reviews*, 14(1): 277-288.
- STEWART, D. J.; BOGUE, M.J and BADGER, D. M. (1984). *Biogas production from crops and organic wastes*. 2. Results of continuous digestion tests. *New Zealand J. Sci.* 27: 285–294.
- THAMSIRIROJ, T. and MURPHY, J.D. (2011): *Modelling mono-digestion of grass silage in a 2 stage CSTR using ADM1*. *Bioresource Technology*, 102: 948–959
- TILMAN, D.; REICH, P. and KNOPS, J. (2006): *Biodiversity and ecosystem stability in a decade-long grassland experiment*. *Nature* 441, 629-632
- WEILAND, P. (2004): *Erfahrungen deutscher Biogasanlagen – Ergebnisse einer bundesweiten Bewertung*. Paper presented at the Minisymposium „Biogasgewinnung aus nachwachsenden Rohstoffen“, University of Natural Resources & Life Sciences Vienna, IFA Tulln, Austria
- WEILAND, P. (2008): *Impact of competition claims for food and energy on German biogas production*. Paper presented at the IEA Bioenergy Seminar, Ludlow, UK, April 17th, 2008.
- WEILAND, P. (2010): *Flaschenhals Gärrestverwertung (Bottleneck digestate treatment)*. Presentation at the Symposium „Aufbereitung von Gärresten“ (Symposium „Digestate Treatment“), University of Natural Resources and Life Sciences Vienna, IFA Tulln, 30.September, Tulln, Austria.

Further reading

A review of the integrated process for the production of grass biomethane.

AS NIZAMI, N E KORRES, JD MURPHY (2009)
Environmental Science and Technology, 43(22): 8496–8508

Anaerobic digestion – A multi faceted process for energy, environmental management and rural development

R. BRAUN (2007)

In: Improvement of crop plants for industrial end users. Ranaoli, P. (Herausg.), Springer Verlag

Handreichung Biogasgewinnung und -nutzung.

FNR (2005). Fachagentur Nachwachsende Rohstoffe e.V. (FNR), Hofplatz 1, D-18276 Gülzow. Website: <http://www.nachwachsenderohstoffe.de/>

Faustzahlen Biogas

KTBL and FNR (2007). Kuratorium für Technik und Bauwesen in der Landwirtschaft (KTBL), D-64289 Darmstadt and Fachagentur für Nachwachsende Rohstoffe (FNR), Hofplatz 1, D-18276 Gülzow, (Editor), ISBN 978-3-939371-46-5

Energiepflanzenbau für Biogasanlagenbetreiber.

KARPENSTEIN-MACHAN, M. (2005); DLG-Verlag, Frankfurt, Germany

Energiepflanzen

KTBL (2006); Kuratorium für Technik und Bauwesen in der Landwirtschaft (KTBL), D-64289 Darmstadt (Editor)

Ökologische und ökonomische Bewertung nachwachsender Energieträger

KTBL Schrift 468. KTBL (2008), D-64289 Darmstadt; ISBN 978-3-939371-68-7

Risk governance guidelines for bio-energy policies

IRGC (2008). Risk Governance Council, Geneva, Switzerland. ISBN 978-2-9700631-0-0

Glossary, terms

Anaerobic Digestion (AD) Biomethanation is the bacterial degradation of organic substances under exclusion of oxygen. The degradation process is also called anaerobic digestion and delivers biogas, which typically contains between 50 and 70% methane, 20 to 45% carbon dioxide and some trace gases.

Combined heat & power plant (CHP) A co-generator driven by a combustion engine, fuelled with biogas, resulting in approx. 60 % heat and 40 % electrical power.

Digestate Digestate is the material that is discharged from the digester vessels at the end of the digestion period. It contains less digestible material including for lignin, minerals

and remnants of bacteria. Typically nutrients in the feedstock are conserved in the digestate and as such it is a good fertiliser.

Dry digestion (dry fermentation) Anaerobic digestion when the dry matter content exceeds about 30 % dry solids in the digester.

Dry Matter (DM) or Dry Solids (DS) Residual substance after complete elimination (drying) of water.

Fermentation (digestion) Anaerobic metabolic processes caused through microbial enzymatic activities.

Greenhouse gas (GHG) Gases which cause global warming; typically including for CO₂, CH₄ and N₂O

Hydraulic residence time (HRT) Mean statistical retention time of substrates in a bioreactor (sometimes called “retention time”).

Mesophilic Temperature range between about 30–42°C.

Thermophilic Temperature range between about 50–57°C.

TS - Total solids Total amount of insoluble matter in a liquid.

VS - Volatile solids Total amount of organic matter in a substance.

Abbreviations

CHP		Combined heat and power plant
d		Day
DM	[%]	Dry Matter
DS	[%]	Dry Solids
EJ	[10 ¹⁸ J]	Exajoule
GHG		Greenhouse gas
GJ	[10 ⁹ J]	Gigajoule
MJ	[10 ⁶ J]	Megajoule
Mtoe	[4.2 x 10 ⁷ GJ]	Million tons of oil equivalent
m _n ³		Volume at standard conditions of 0°C, 101.325 kPa
Pa	[1 N/m ²]	Pascal (1 bar = 10 ⁵ Pa)
PJ	[10 ¹⁵ J]	Petajoule
ppm		Parts per million
TJ	[10 ¹² J]	Terajoule
TS	[%]	Total solids
VS	[%]	Volatile solids
v/v	[%]	Percent referred to volume
Wobbe index	[MJ.m ⁻³]	Amount of energy introduced to the burner
w/w	[%]	Percent referred to weight

