

Status overview of torrefaction technologies

A review of the commercialisation status of biomass torrefaction



This publication provides an update of the status of commercialisation of biomass torrefaction. It contains both a review of recent research efforts and an overview of the progress made in commercialisation of the technology.

IEA Bioenergy

IEA Bioenergy: Task 32:
Biomass Combustion and Cofiring

Status overview of torrefaction technologies

A review of the commercialisation status of biomass torrefaction

Authors:

Marcel Cremers, DNV GL, Netherlands

Jaap Koppejan, Procede Biomass, Netherlands

Jan Middelkamp, DNV GL, Netherlands

Joop Witkamp, DNV GL, Netherlands

Shahab Sokhansanj, UBC, Canada

Staffan Melin, UBC, Canada

Sebnem Madrali, CanmetENERGY

Copyright © 2015 IEA Bioenergy. All rights Reserved

ISBN 978-1-910154-23-6

Published by IEA Bioenergy

Executive Summary

This report provides an update of the Status overview of torrefaction technologies, which was produced by IEA Bioenergy Task 32 in 2012. The reason for this action was the observation that commercialisation of torrefaction technologies has been more difficult than earlier anticipated.

The maturation and market introduction of torrefaction technologies has gone slower than anticipated 5 years ago, when it was expected that a significant fraction of the biomass pellets supplied today could have been replaced by torrefied pellets. It has been hard to fully prove the claims made earlier on product characteristics, and several companies have gone bankrupt due to inability to produce good quality product or due to a lack of buyers.

Nevertheless, it is clear that the companies involved have significantly improved their ability to produce high quality products, with pellets of comparable durability to conventional wood pellets. The torrefied pellets exhibit comparable supply costs, however end users should be convinced that the claimed superior handling and combustion characteristics do translate into an economic advantage that can counterbalance the perceived risk.

As for conventional wood pellets, price parity with coal is essential to enable commercial market introduction of torrefied biomass for co-firing. In the absence of a substantial price penalty for CO₂ emissions and with the low price level of coal, this implies that typically additional subsidy schemes should be in place.

Table of contents

EXECUTIVE SUMMARY	1
TABLE OF CONTENTS	2
1 INTRODUCTION	4
2 FUNDAMENTALS AND KEY ISSUES	5
2.1 TORREFACTION PROCESS	5
2.2 MASS AND ENERGY BALANCES	6
2.3 PELLETISATION.....	8
2.4 HYGROSCOPIC NATURE	9
2.5 SELF-HEATING	10
2.6 IGNITION OF DUST.....	10
2.7 GRINDABILITY	11
2.8 COMBUSTION BEHAVIOUR.....	11
2.9 LOGISTICS.....	12
3 TORREFACTION TECHNOLOGIES	14
3.1 ROTATING DRUM REACTOR.....	14
3.2 SCREW TYPE REACTORS	15
3.3 MULTIPLE HEARTH FURNACE (MHF) OR HERRESHOFF OVEN	16
3.4 FLUIDIZED BED REACTOR	17
3.4.1 <i>Bubbling bed reactors</i>	17
3.4.2 <i>Toroid or torbed reactor</i>	18
3.5 MOVING BED REACTOR	19
3.6 BELT AND VIBRATING GRATE REACTOR	20
3.7 MICROWAVE REACTOR.....	21
4 TORREFACTION TECHNOLOGY DEVELOPERS	22
4.1 TORR-COAL GROUP	25
4.2 TOPELL ENERGY BV	26
4.3 SOLVAY BIOMASS ENERGY	27
4.4 TEAL SALES INC.	29
4.5 AIREX ENERGY	30
4.6 RIVER BASIN ENERGY	32
4.7 ARIGNA FUELS	33
4.8 EARTH CARE PRODUCTS INC.	34
4.9 TORREC.....	36
4.10 TERRA GREEN ENERGY.....	37
5 CHALLENGES FOR MARKET IMPLEMENTATION	39
5.1 LIMITED STAFF DEDICATED TO TECHNOLOGY DEVELOPMENT	39

5.2	FEEDSTOCK FLEXIBILITY	39
5.3	TREATMENT OF TORREFACTION GASES	39
5.4	PERSPECTIVES ON PROCESS UPSCALING	40
5.5	PROCESS CONTROL	41
5.6	PRODUCT QUALITY/CONSISTENCY	41
5.7	DENSIFICATION AND PELLET DURABILITY	41
5.8	HEALTH AND SAFETY (HSE)	42
6	RECOMMENDATIONS	43
6.1	PRODUCTION SCALE UP	43
6.2	END USER CONFIDENCE	43
6.3	LOWER PRODUCT PRICE	44
6.4	PRODUCT STANDARDS	44
6.5	STANDARDS FOR SUSTAINABILITY AND TRACEABILITY	45
6.6	TORREFYING WASTES	45
7	CONCLUSIONS.....	46
7.1	RECENT TECHNOLOGY DEVELOPMENT	46
7.2	THE BUSINESS CASE	47
7.3	POLITICAL AND LEGISLATIVE CONSTRAINTS	47
8	REFERENCES	48

1 Introduction

In 2012, IEA Bioenergy Task 32 published the report "Status overview of torrefaction technologies". The report describes the process of torrefaction, an overview of torrefaction technologies, applications of torrefied biomass and the economic value of torrefied pellets. This report has been received in the public domain as a valuable report.

After a rapid initiation of the torrefaction technology up to 2012 the general public opinion currently is that torrefaction suffers from a stand-still. However, the torrefaction technology is in the development stage, and it is considered important to report on development steps that have been taken recently.

Therefore, Task 32 decided to update the 2012 torrefaction report. The current report includes an update of torrefaction developers, as well as their status and views on the torrefaction technology, its product and any opportunities and obstacles that favour or hamper further introduction of the technology and its product. This is mainly done by means of questionnaires and performing interviews with the developers.

It includes also some key results of the SECTOR project. SECTOR (Production of Solid Sustainable Energy Carriers from Biomass by Means of TORrefaction) was a large-scale European FP7 research project that focused on the further development of torrefaction-based technologies for the production of solid bioenergy carriers up to pilot-plant scale and beyond, and on supporting the market introduction of torrefaction-based bioenergy carriers as a commodity renewable solid fuel¹.

¹ <https://sector-project.eu/project-brief.10.0.html>

2 Fundamentals and key issues

This chapter explains the fundamental aspects on torrefaction, and the mechanisms that influence the quality of the fuel produced. In several cases reference is made to some of the key findings of the SECTOR project. This was a major EU FP7 funded research project of 21 partners from 9 European countries, aimed at addressing the key technical and non-technical issues that hamper commercialization of torrefaction technologies.

2.1 TORREFACTION PROCESS

Lignocellulosic biomass typically contains approx. 80 % volatile matter and 20% fixed carbon on dry mass basis. During the torrefaction process, solid biomass is heated in the absence of or drastically reduced oxygen to a temperature of approx. 250-320°C, leading to a loss of moisture and partial loss of the volatile matter in the biomass. With the partial removal of the volatile matter (about 20%), the characteristics of the original biomass are drastically changed. The tenacious fibre structure of the original biomass material is largely destroyed through the breakdown of hemicellulose and to a lesser degree of cellulose molecules, so that the material becomes brittle and easy to grind. The material then changes from being hydrophilic to becoming hydrophobic. With the removal of the light volatile fraction that contains most of the oxygen in the biomass, the heating value of the remaining material gradually increases from 19 MJ/kg to 21 or 23 MJ/kg for torrefied wood and eventually 30 MJ/kg in the case of complete devolatilization resulting in charcoal.

The torrefaction degree depends typically on the time that a (dry) biomass particle resides in the torrefaction reactor and on the temperature inside the reactor. The higher the temperature or the longer the residence time the higher the torrefaction degree. Torrefaction temperature and residence time however are not to be totally interchangeable [Strandberg et al., 2015].

Although there are some variations in the range of process conditions applied for the various reactor concepts, the basic concept for torrefaction and densification processes is the same and commonly incorporates heat integration, see Figure 2-1.

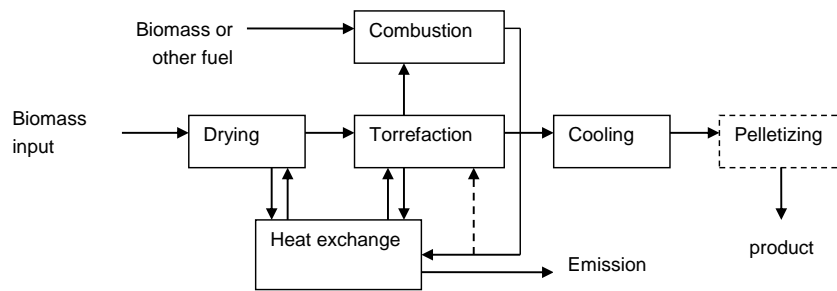

Figure 2-1 Overview of heat integration options.

The thermal energy required for the drying and torrefaction process is delivered by combustion of torrefaction gas, eventually assisted by an auxiliary fuel. In a properly designed and operated torrefaction system, the energy contained in the torrefaction gases may be sufficient to sustain both the drying process and the torrefaction process. However, this strongly depends on the moisture content of the incoming biomass (latent heat requirement) and the required degree of torrefaction (the degree of mass loss and the availability of combustible volatiles). It is therefore important to dry the biomass before it enters the torrefaction reactor, since moisture entering the torrefaction reactor results in more humid torrefaction gas which lowers the adiabatic flame temperature. For very wet torrefaction gas, there might not even be sufficient energy contained in the gas to reach a temperature for complete combustion (at least 900 °C required). For this reason, moisture content of incoming biomass to the torrefaction reactor should normally not exceed approx. 15%. However, depending on the torrefaction concept and the economics of the feedstock considerably higher moisture content may turn out to be beneficial. The net efficiency of an integrated torrefaction process is approx. 70 - 98%, depending on the reactor technology, concept for heat integration and the biomass type.

2.2 MASS AND ENERGY BALANCES

For typical process conditions and characteristics of raw biomass used and torrefaction degree, the energy contained in the volatiles released during the torrefaction process (torgas) is of the same order of magnitude as the heat required to drive off moisture contained in the feedstock.

Figure 4.2 illustrates the Energy Yield, defined as the lower heating value of the torrefied product divided by the total LHV of the input biomass against the moisture content of input biomass. It is assumed here that the volatile gases released during torrefaction are combusted to dry the input biomass and supplemented with combustion of additional biomass fuel. The thermal process efficiency depends on the removal of volatiles and the moisture content of the input biomass used.

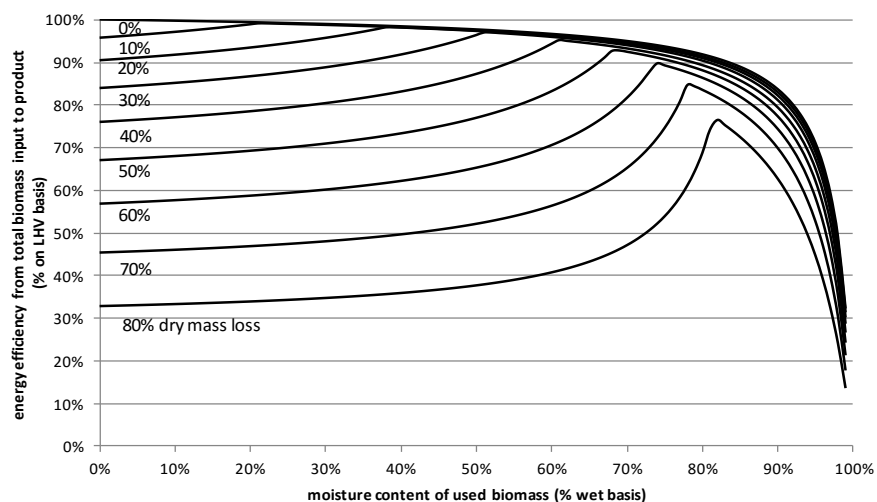

Figure 2-2 Theoretical Energy Yield of an integrated torrefaction process, assuming clean wood (0.5% ash content) as raw material and heat requirement of the drier of 2.9 MJ per kg of water evaporated (75% efficiency).

Figure 2-2 shows that for typical torrefaction conditions where about 20% of the dry mass is removed in the form of volatile gases (often named 'torgas'), the thermal energy efficiency of a torrefaction process with proper heat integration shows very high conversion efficiencies exceeding 90%, since the energy contained in the removed volatile fraction can be used to drive off the moisture in the dryer. The process efficiency drops with higher devolatilization rates (more than about 20-30%) and lower moisture content biomass, because the energy contained in the released volatiles is more than what is required for removing moisture in the biomass dryer. The process efficiency is also less than optimal for wet biomass fuels (e.g. green wood, fresh grasses, etc.) due to the inefficiency of the dryer.

For the demonstration facilities involved in SECTOR, energy balances were produced. The results are given in Table 2-1. These are in the same range as Figure 2-2.

Table 2-1 Main results and parameters from M&E balances of different technologies of pilot test plant in SECTOR project for pine torrefaction [Gil et al, 2014]

Partner	CENER	UmU	ECN
Torrefaction technology	Indirectly in- and externally heated rotating shaft	Rotating drum	Directly heated moving bed
Heat transfer type	Indirect heating	Indirect heating	Direct heating
Mass yield	79% db	75,7% db	81,3% db
Energy yield	90,5% db	87,9% db	87,6% db
Net thermal efficiency	92,1 %	83,6 %	92,4 %
Thermal energy Consumption	0,46 kWh/kg	0,30 kWh/kg	0,34 kWh/kg

2.3 PELLETISATION

By pelletizing torrefied biomass, a number of advantages can be achieved in transport, handling and storage in comparison to torrefied biomass chips as the intermediate product. While the volumetric energy density (in GJ per m³) of torrefied biomass chips is more or less equal to that of the original material (wood chips), the compression step increases this by a factor of 4-8 leading to significant cost savings in shipping and storage, shipping meaning transportation with truck, train or ocean vessel. The pelletized product can be pneumatically transported to intermediate storages or the coal pulverisers or hammer mills and is less sensitive to degradation and moisture uptake when compared to wood chips or pulverized fuels.

Torrefied biomass is more difficult to press into firm pellets than raw biomass. The energy consumption of the pelletisation process itself is higher per ton of torrefied biomass if compared to e.g. wood pellets (about 80-210 kWh/ton vs. 50-60 kWh/ton for wood pellets) [Stelte et al, 2012]. This depends on biomass type, moisture content and particle size, type of mill and pellet die chosen, and dimensions of the press channel. Preparing a strong pellet therefore requires optimization of the process conditions during torrefaction as well as pelletisation. Earlier a number of companies involved in torrefaction used binders such as glycerine, paraffin, molasses, lignin, bio plastics or condensable fraction of torrefaction gas. Adding the proper amount of water to the torrefied biomass and increasing the pelletizing die temperature lowers the compression energy and friction and results in stronger pellets) [Stelte et al, 2012].

2.4 HYGROSCOPIC NATURE

The drying and subsequent torrefaction processes removes all water from the original biomass. In addition, during the torrefaction process OH-groups are substituted by unsaturated non-polar groups, which results in a great loss of water adsorbing capacity. The hydrophobicity of torrefied material makes the fuel less sensitive for degradation (rotting), self-heating and moisture uptake.

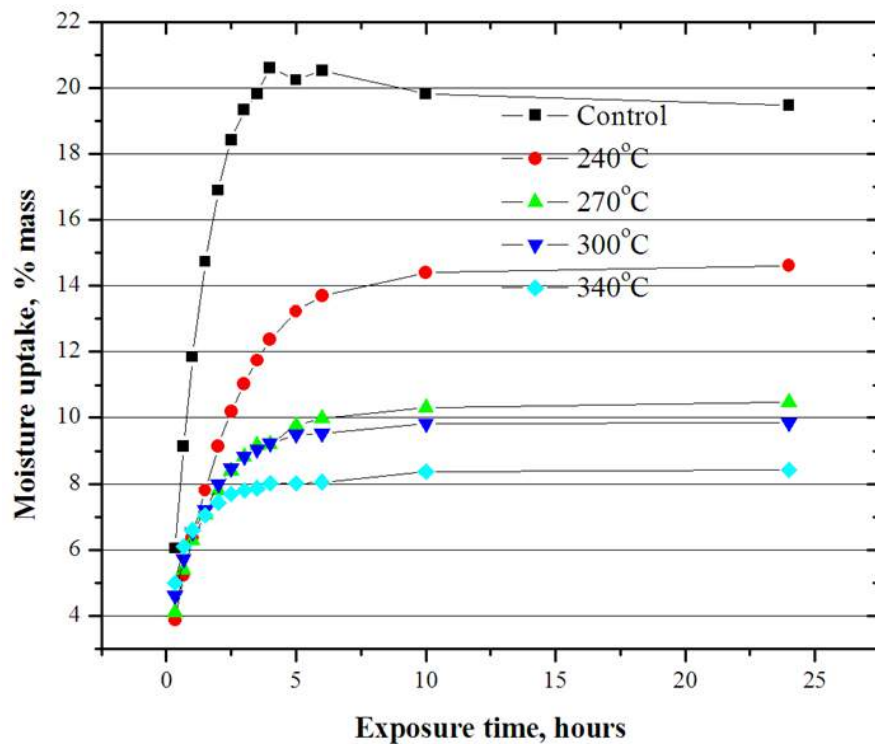

Figure 2-3 Hygroscopicity of 6 mm pellets made from torrefied wood at temperatures from 240-340°C. The control is regular white pellets, Tests were done at 30°C and 90% relative humidity (RH). UBC/CHBE, Feb. 2011.

Figure 2-3 illustrates the hygroscopic characteristics of one type of torrefied pellets (without binder or additive) as a function of time and relative humidity at a certain ambient temperature.

ISO Technical Committee 238 is developing testing standards for determination of hygroscopicity (sorption of relative humidity in air), absorbance of water and freezing characteristics. The hydrophobicity is not the focus of determining the weather-resistance of torrefied pellets but rather the effect on durability caused by hygroscopic sorption, water absorbance and destruction of the mechanical integrity of the pellets.

SECTOR experiments revealed that after long term exposure to humid air (90% rel. humidity), an increase in moisture content was observed from about 2.5-3 wt.% immediately after production up to 10-11.5 wt.% [Nanou et al, 2014a]. This increase in moisture content does not significantly affect the mechanical durability of properly pressed pellets, but pellets that already have a relatively low mechanical durability before exposure are further weakened.

2.5 SELF-HEATING

Similar to pellets produced from fresh biomass, one should take precautions to avoid excessive self-heating in a pile of pellets from torrefied fresh biomass. Research in SECTOR on self-heating showed that the temperature of freshly torrefied material first increases, mostly in the middle of a pile (e.g. 45-70°C was observed for beech wood, depending on biomass type) [Nanou et.al., 2014b]. Ignition temperatures of torrefied biomass species (forest residues, spruce, pine and poplar) appear to be within the same temperature range between 210-230 °C.

Cruz Ceballos et al. [Cruz Ceballos, 2015] showed that bio-char had a higher susceptibility for self-heating when compared to the original feedstock, as torrefaction increases carbon content and depletes volatile compounds resulting in an increase in available oxidation sites.

2.6 IGNITION OF DUST

One of the key concerns for large power plants is the risk of dust generation during storage and handling since there are concerns that the dust could be highly explosive as is the case for dust created during the handling of normal wood pellets.

In SECTOR, research was performed to address the risk of explosion from dust originating from torrefied biomass. The minimum ignition energy (MIE) of sample powders was determined using a modified Hartmann tube as the explosion vessel, following the European Standard EN 13821:2002. The results showed that particularly dust from torrefied spruce, raw spruce and dust produced by a cutter mill has relatively low minimum ignition energy of 3-10 mJ, while dust from torrefied biomass produced from other biomass types or produced in other ways usually exhibit a somewhat higher MIE [Albelha 2014].

Medina et al. [Medina, 2015] presents explosion characteristics of two torrefied wood types. The torrefied wood samples showed overpressures of around 9 bar for all biomass samples irrespective of size or sample composition. Derived laminar burning velocities ranged between 0.1-0.12 m/s, and were much higher than for coal (0.04 m/s). [Medina, 2015] concludes that a few typical torrefied biomass samples examined can be classified as St-1 dusts (moderately explosible) according to their K_{st} value. One therefore has to take adequate precautions. In order to avoid dust clouds, mist spraying may be needed in some cases.

2.7 GRINDABILITY

During torrefaction, the hemi-cellulose fraction which is responsible for the fibrous nature of biomass degrades, which improves its grindability and changes the particle shape after milling from needles to spheres. According to [Strandberg et al, 2015], typical reductions of 95% in milling energy requirements can be achieved. The particle shape is closer to coal particles and favors conveyance in conventional coal pneumatic feeding systems.

Hardgrove Grindability Indices of torrefied fuels vary between about 23 and 53. This can be compared to bituminous coals which are mostly around 40 for difficult to mill coals to values in excess of 70 for softer, more friable coals. [Ndibe et al, 2014]

2.8 COMBUSTION BEHAVIOUR

Combustion of torrefied material in a coal fired power plant will reduce the amount of inorganics in the overall fly-ash, simply because the torrefied fuel (just as the original raw biomass) contains significantly less amount of ash than coal (0.4% - 5% on a dry mass basis, compared to 5% - 20% for coals).

As for cofiring raw biomass, the higher volatility implies that if the same particle size distribution is used for cofiring torrefied biomass as for coal, a reduced mass of unburned carbon ends up in the fly ash. However this does not necessarily imply that the Loss on Ignition (LOI) in the fly ash also decreases, since (torrefied) biomass also contains significantly less ash than coal. In case coarser particles of torrefied biomass are used as a fuel, as is typically done when cofiring biomass with coal, the amount of unburned carbon in the fly ash increases.

CFD calculations were performed in SECTOR to examine the combustion behaviour of torrefied biomass in two typical pulverised coal fired boilers [Gulik et al, 2014]. These calculations showed that as a result of the higher amount of volatiles in the fuel, more fuel gas is produced when burning torrefied material causing the combustion reaction to extend higher up in the combustion chamber. When coal is completely replaced by torrefied biomass, the flame size can increase up to about 25%. The torrefied biomass flame will also start more quickly and may grow backwards towards the burner. These issues are all manageable in practice.

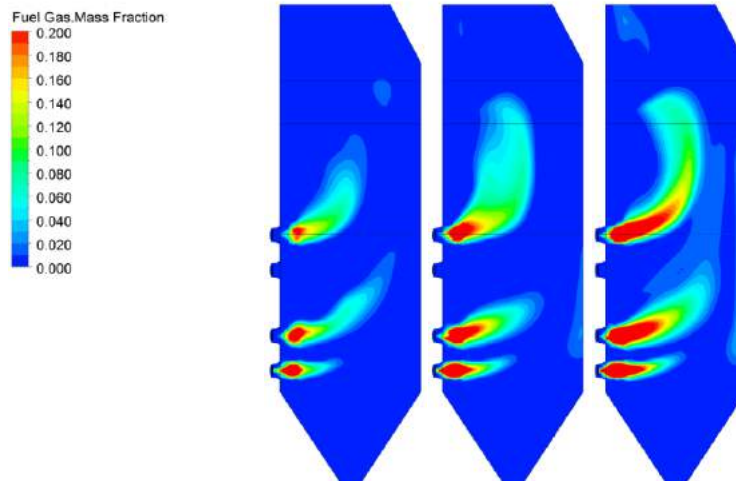

Figure 2-4 Simulated fuel gas mass fraction during combustion in a typical PC boiler: left: 100% hard coal, middle: 50% hard coal/50% torrefied biomass, right: 100% torrefied biomass.

Regarding emissions, it can be observed that (torrefied)-woody biomass with coal lowers SOX emissions, mainly as a result of dilution. NOX emissions have a more complex dependency on the nitrogen content, with additional influence from furnace and burner configurations. Due to the lower nitrogen contents in torrefied biomass, it is typically possible to reach lower NOX emissions.

There may be other impacts on power plant integrity such as superheater corrosion, ash deposition, ESP or SCR performance, etc. It is anticipated that these effects are similar or even better for torrefied biomass and raw biomass, as the inorganic composition of the fuel is not adversely affected during torrefaction[Gulik et al, 2014]. Some recent research has even shown that the torrefaction process may even result in a reduction of chlorine content up to 90% [Keipi et al, 2014]. This reduces the corrosion risk drastically.

2.9 LOGISTICS

Currently, torrefied material does not have a safety classification under International Maritime Organization (IMO) and cannot be transported by ocean vessels without special permission since the product has similarities with charcoal, which is prohibited to be transported in bulk. Based on extensive safety tests carried out, the US Department of Homeland Security has earlier issued a 3-years permit to allow for shipment of torrefied biomass. It is however needed that torrefied biomass can be shipped under clear regulations. Adequate product standards are currently developed in ISO that should provide confidence to end users that the torrefied products offered meet the customer requirements [Alakangas, 2014].

Within SECTOR, a Material Safety Data Sheet was developed to facilitate trade between business partners [Hoeft 2013].

Whether registration under REACH (EC No. 1907/2006) for torrefied material is required, cannot be unequivocally determined at present. On one hand the feedstock, solid biomass either from lignocellulose plants, or from agriculture residues, requires it. But by going through a heat treatment in an oxygen deficient environment, the resulting product is comparable to coal, which is also not under the obligation to register and covered by the regulation in Annex V/7.

3 Torrefaction Technologies

Different reactor technologies which were originally developed for other applications have been modified to perform torrefaction. Some torrefaction technologies are capable of processing feedstock with only small particles such as sawdust whereas others are capable of processing large particles. Only a few reactor types can handle a wider range of particle sizes. This means that selection of technology needs to be done based on the characteristics of the feedstock, or alternatively, the feedstock needs to be pre-processed before entering the torrefaction reactor. The need for size reduction equipment, such as scalpers for handling over-sized material or sieves for extraction of small particles will increase capital as well as operating cost of a torrefaction facility. This must be offset against the lower costs of feedstock that requires such pre-processing.

Table 3-1 provides an overview of the most important reactor technologies and the companies involved.

Table 3-1 Overview of reactor technologies and some of the associated companies

Reactor technologies	Companies involved
Rotating drum reactor	Andritz (AT), CENER (SP), EarthCare Products (USA), Teal Sales Inc (USA), Torr-Coal (NL)
Screw reactor	Agri-tech Producers (USA), Arigna Fuels (IR), BioEndev (SWE), Solvay Biomass Energy (USA)
Herreshoff oven / multiple hearth/tray reactor	CEA/CMI-NESA (FR/BE), Integro Earth Fuels (USA), Terra Green Energy (USA), Wyssmont (USA)
Fluidized bed reactor	Airex (CAN), Bioenergy Development & Production (CAN), Topell (NL)
Microwave reactor	Rotawave (UK)
Moving/fixed bed	Andritz/ECN (DK/NL), AREVA (FR), Grupo Lantec (SP), LMK Energy (FR), New Earth Renewable Energy Fuels (USA), Torrec (FI)

The most important reactor technologies are described below.

3.1 ROTATING DRUM REACTOR

The rotating drum is a continuous reactor and it can be regarded as proven

technology for various applications. For torrefaction applications, the biomass in the reactor can be either directly or indirectly heated using superheated steam or flue gas resulting from the combustion of volatiles. The torrefaction process can be controlled by varying the torrefaction temperature, rotation speed and length and slope angle of the drum.

The drum rotation causes particles in the bed to mix properly and exchange heat, but it also initiates attrition which results in additional fines. Rotating drums have been thought to have a limited scalability and therefore higher capacities have thought to be achieved by modular setup. At the same time for rotary drum drying of wood chips, scaling has been proven, with scaling up to 600 ktons/year in one drum. This might also be a way to go for torrefaction, but needs to be proven in the field.

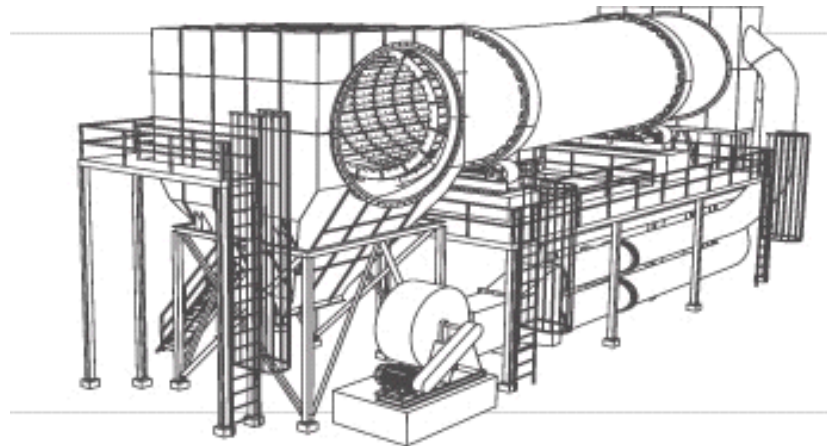

Figure 3-1 Rotating drum reactor

3.2 SCREW TYPE REACTORS

A screw type reactor is a continuous reactor, consisting of one or multiple auger screws that transport the biomass through the reactor. The reactor technology can be considered as proven technology and it can be placed both vertically as well as horizontally. A screw reactor is generally heated indirectly using a medium inside the hollow wall or hollow screw. There are, however, variations of the reactor design where heat is applied directly when using a twin screw system. A disadvantage of indirectly heated screw reactors is the potential formation of char on the hot zones. Further, the addition of heat in a screw reactor is rate-limited because of the limited mixing of the biomass. The residence time inside the reactor is determined by the length and rotation speed of the screw. A screw reactor is relatively inexpensive, but the scalability is limited as the ratio of screw surface area to reactor volume decreases for larger reactors. However, some reactor designs include highly efficient agitation gear for improved heat transfer, which enables larger reactor volumes.

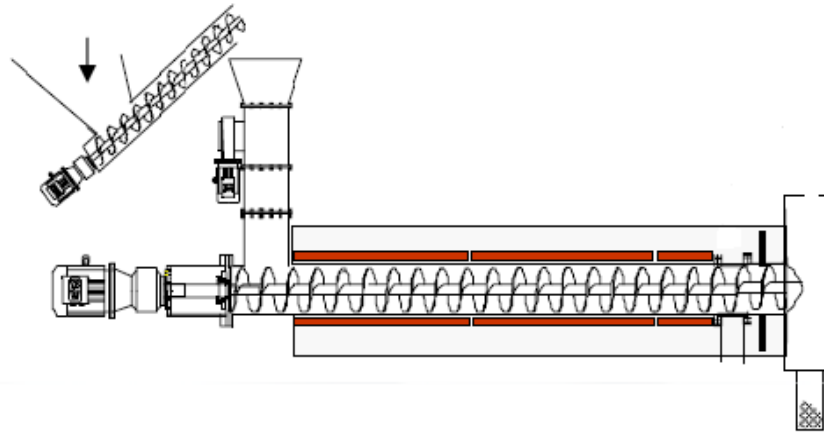

Figure 3-2 Auger screw type reactor

3.3 MULTIPLE HEARTH FURNACE (MHF) OR HERRESHOFF OVEN

This is a continuous reactor, consisting of multiple layers. It has been proven for various other industrial applications. On every individual layer, a single phase in the torrefaction process takes place. On the subsequent layers, the temperature gradually increases from e.g. 220 °C to 300 °C. Biomass enters from the top side of the reactor on a horizontal plate and it is pushed mechanically to the inside. It then falls down through a hole in the plate on a second plate, where biomass is pushed mechanically to the outside, where it falls through another hole, etc. The process is repeated over multiple layers, causing uniform mixing and gradual heating. Heat is applied per individual reactor layer directly using internal gas burners or on steam injection. In the upper reactor layers biomass is dried, whereas in the lower layers torrefaction takes place. The MHF reactor can be scaled up to a diameter of 7 to 8 meter, which results in relatively low specific investments (expressed in Euro per ton/h of product) for large scales. The burners may use natural gas or suspension burners for wood dust originating from the feedstock. The use of natural gas (being a fossil fuel) will have impact on the GHG balance for the torrefied product.

The MHF technology can process a wider variety of feedstock particle sizes, ranging from saw dust to larger chips and even scraps. The technology is well suitable for research purposes, since each step of the torrefaction sequence can be conveniently accessed for material and gas sampling. In addition, accurate adaptive temperature control and injection of additives is feasible. Typical processing time is 30 minutes from top to bottom, requiring high specific reactor volumes.

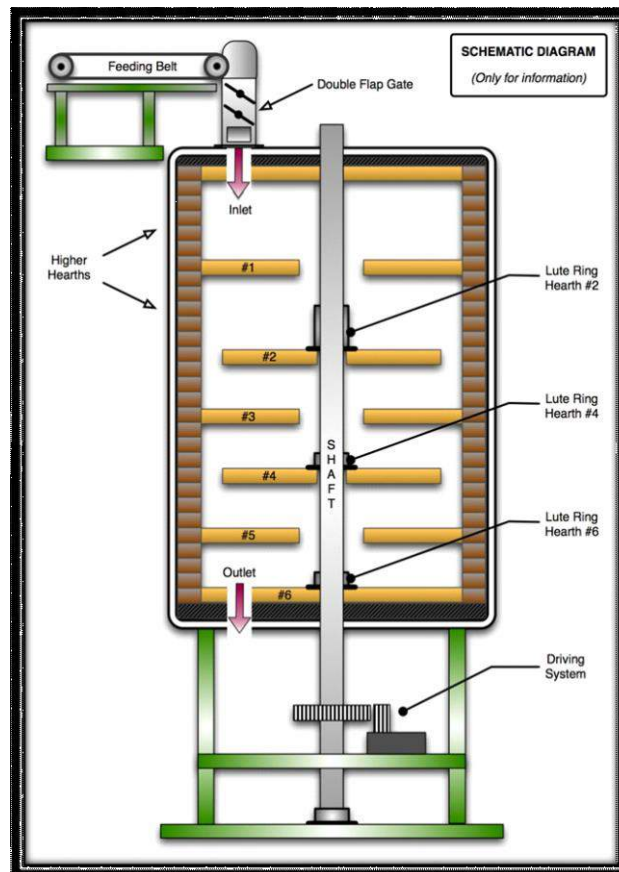

Figure 3-3 Multiple Hearth Furnace (MHF)

3.4 FLUIDIZED BED REACTOR

The fluidized bed reactor technology can be considered as proven technology for various industrial applications, including combustion. Different types of fluidized beds are currently applied for torrefaction, including bubbling fluidized beds and toroid fluidized beds. An important characteristic of fluidized beds in general is the intense contact between the solid and the gas phase, providing a high heat transfer rate between the two phases. This is an important reason why a number of torrefaction developers have adopted the fluidized bed technology.

3.4.1 Bubbling bed reactors

In bubbling bed reactors the solid phase is gently fluidized by the gases entering or and/or formed in the lower part of the bed, creating a relatively dense fluid of the solids, resulting in a rather compact reactor design. Bubbling fluid beds have good heat transfer characteristics, though the absolute levels are lower when compared to circulating or toroid fluidized beds. As a result, solids in a bubbling bed reactor can be heated in a gentle and controlled way.

A less favorable characteristic of the technology is the wide spread in residence time for the particles. As a result, bed temperature is a key parameter for producing an evenly torrefied product.

3.4.2 Toroid or torbed reactor

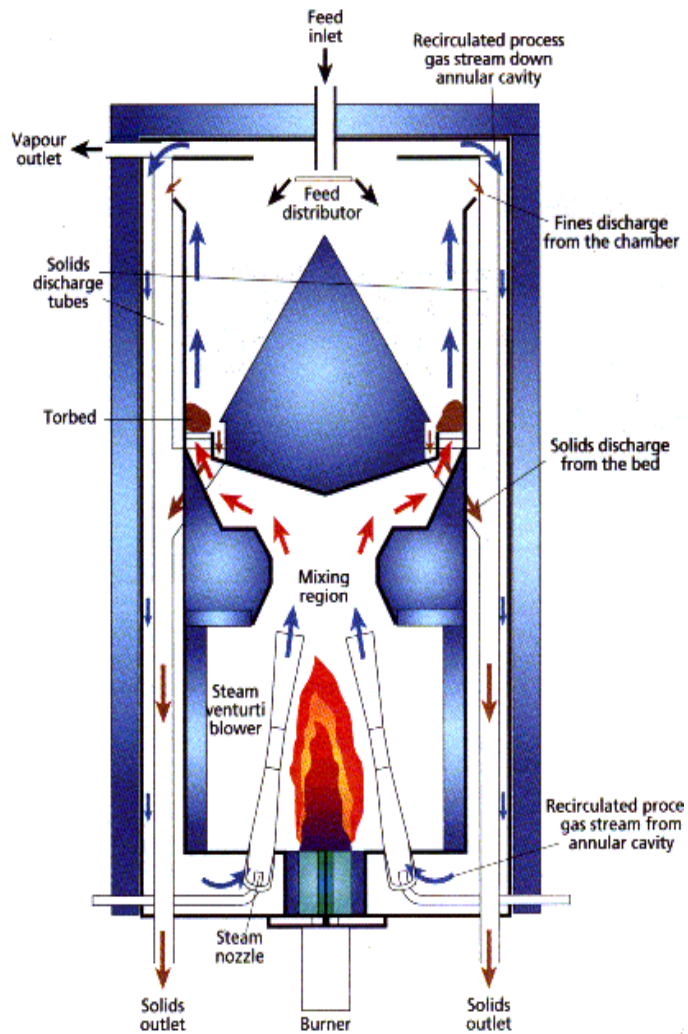

Figure 3-4 Torbed reactor

In a toroid or torbed reactor, a heat carrying medium is blown from the bottom of the bed with high velocity (50 - 80 m/s) past stationary, angled blades. This gives the biomass particles inside the reactor both a vertical and a horizontal movement, resulting in toroid swirls which very rapidly heat the biomass particles on the outer walls of the reactor. This relatively intense heat transfer enables torrefaction with short residence times (around 80 sec), which results in relatively small reactor sizes. The intense heat transfer could also be used to operate the reactor in a controlled way at elevated temperatures (up to 380 °C), resulting in higher loss of volatiles. This gives the technology a particular flexibility in preparing product for different end use markets. However, the process is sensitive to variation in particle size of the feedstock.

3.5 MOVING BED REACTOR

This continuous reactor consists of an enclosed reactor vessel, where biomass enters from the top and moves down gradually while the torrefaction process takes place as a result of a heat carrying gaseous medium, which enters at the bottom and moves to the top of the reactor. The reactor does not entail any moving parts. At the reactor bottom, the torrefied product leaves the reactor and is cooled down. At the top of the reactor, gaseous reaction products (volatiles) are collected. The torrefaction process conditions are similar to many other technologies (residence time 30 - 40 minutes; process temperature approximately 300 °C).

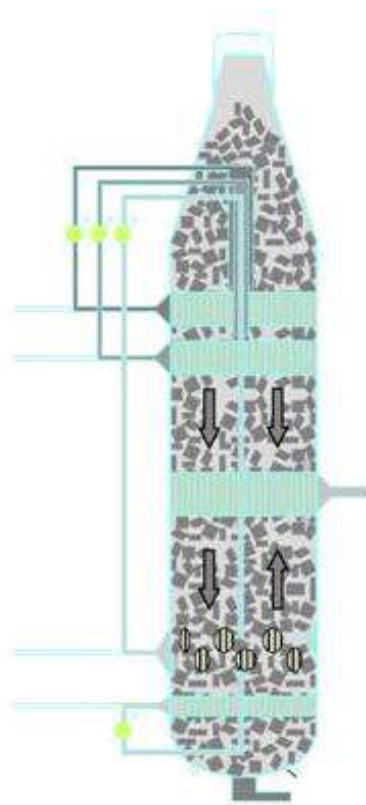

Figure 3-5 Moving compact bed

Due to the absence of proper mixing of biomass particles, there is a risk of channelling of the heat carrying medium through the bed, which may lead to a non-uniform product at the reactor bottom. Although this effect has not yet been observed at a 100 kg/h demonstration scale, it may be a significant risk for larger facilities: vertical gas flow "tunnels" may cause an un-even temperature distribution across the diameter of the reactor. This may be further enhanced by variations in the particle size of the feedstock.

The degree of filling of this reactor is relatively high if compared to many other designs, since the full reactor volume is used for holding the biomass. As a result, the reactor volume is relatively low but the pressure drop over the bed

is relatively high, particularly when processing smaller (<5 mm) biomass particles. This can be partly avoided by sieving the biomass input material, however, the formation of smaller particles inside the reactor due to attrition cannot be avoided, particularly in the bottom of the reactor where the pressure is highest.

3.6 BELT AND VIBRATING GRATE REACTOR

Belt and vibrating grate dryers can be considered as proven technology for biomass drying applications. While biomass particles are transported using a moving, porous belt or a vibrating grate, they are directly heated using a hot gaseous medium. In a belt dryer reactor, usually multiple belts are placed on top of one another. While biomass particles fall from one belt on the other, mixing of the particles takes place, resulting in a more homogeneous product. Vibrating grate reactors are designed in a similar way.

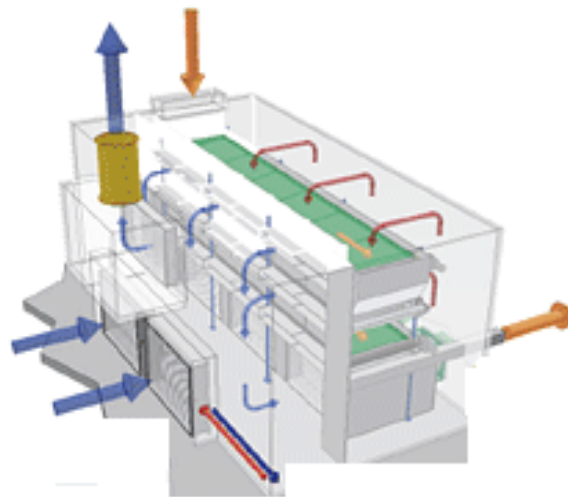

Figure 3-6 Belt dryer

By controlling the belt speed or the grate vibration frequency, the residence time for all particles inside the reactor can be well controlled, particularly for belt reactors. These can be considered a perfect plug flow reactor, in contrast to several other reactor concepts where there might be substantial spread in residence time, leading to either charred particles or not yet properly torrefied particles from the same reactor.

A potential disadvantage of the technology is clogging of the open structure of the belt or grate by tars or small particles. Further, the volume limited throughput makes the reactor less suitable for biomass materials with low bulk densities. Also, the options for temperature control inside the reactor are limited since the process can only be controlled with the temperature of the gas entering the reactor and the velocity of the belt or the vibration frequency

of the grate. Specific investment costs for this reactor technology are relatively low.

3.7 MICROWAVE REACTOR

An alternative technology for producing torrefied biomass is based on the use of microwave energy for heating of the biomass. Major advantage would be the homogenous heating (from the inside) of the material, which enable it to use a wider range feedstock particle sizes. A key disadvantage, however, is that electricity is required for the microwave technology, which is difficult to generate at acceptable efficiencies from the torrefaction gas. This negatively influences the energy efficiency of the process. Alternatively, green electricity could be applied, but this will come at substantial costs.

4 Torrefaction technology developers

This section provides an international overview of major project initiatives in Europe and North America. Table 4-1 shows an overview of about half of the torrefaction initiatives in Europe and North America. It is estimated that there are over 50 companies involved in developing torrefaction technologies, with various efforts and at a wide range of involvement and development levels.

Compared to 2012, a number of new entrants have appeared, whereas a number of developers that were mentioned in the 2012 report have disappeared or the status is unknown (sleeping).

Some developers are backed by major companies and they are developing torrefaction in cooperation within these companies. These are mostly original equipment manufacturers of biomass and or thermal treatment/conversion equipment. Other developers are relatively small (< 10 employees) and have a limited financial basis, resulting in the need to attract external investors. These investors are typically venture funds, governmental bodies, end-users and banks (lenders).

Finally, an increasing number of research institutions have their own torrefaction pilot facilities at various scales. They have a number of employees performing research work and in some cases they are offering test services to external parties. A large number of scientific documents has been published over the last 10 years and this number has increased rapidly since around 2010.

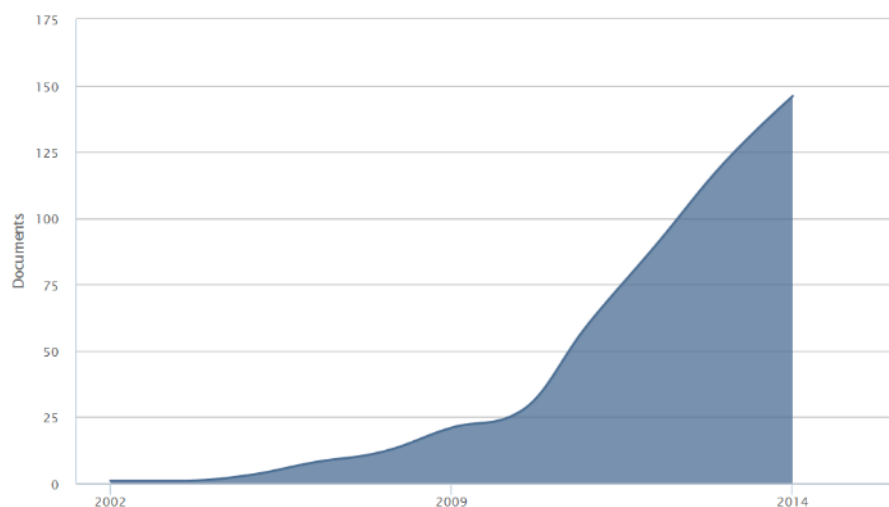

Figure 4-1 Number of documents published that include the word "torrefaction" in the title, abstract or keywords, per year 2002 until and with 2014. Derived from Scopus.

The total number of documents reached 490, spread over around 160 research institutes, universities and companies. Of these 490 documents, over 90% are articles (published or in press) or conference proceedings (published or in press). The rest are in articles and proceedings in review, book chapters, notes, editorials and short surveys. Most articles originate from the United States.

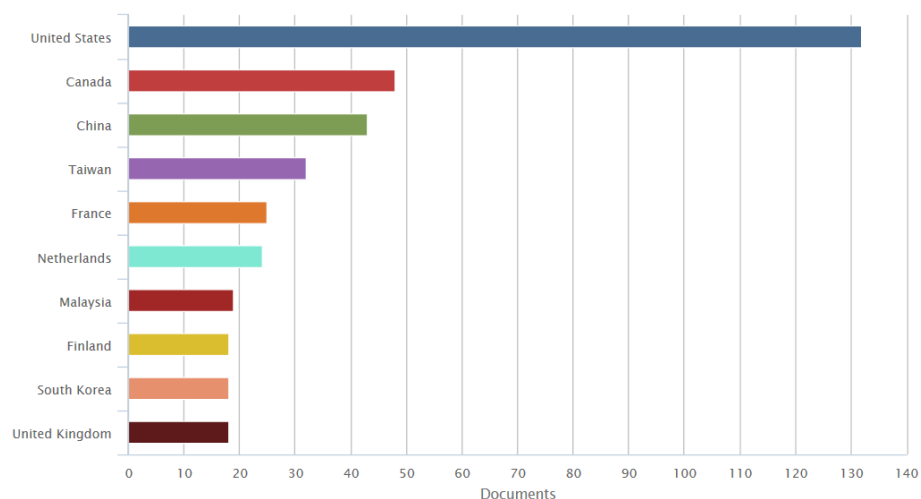

Figure 4-2 Documents counts by country for scientific articles that include the word "torrefaction" in the title, abstract or keywords, per year 2002 until and with 2014. Derived from Scopus.

Data search from LexisNexis data (patent result) provides 135 "torrefaction" patent results, with the majority (89 out of 130) post-2010, of which 33 in 2012 and 27 in 2013.

Table 4-1 presents the status of a number of major developers that have constructed a pilot, demonstration or commercial facility. The table is based on the authors experience and knowledge in the torrefaction market. The table is produced such to achieve the highest degree of accuracy and it is based on actual site visits, personal communication with key persons and questionnaires.

Table 4-1 Overview of some torrefaction initiatives as of 2015, based on technology and facility scales

Developer	Technology	Location(s)	Production capacity (ton/a)	Scale and status Pilot scale: 50 kg/h - 500 kg/h Demo scale: > 500 kg/h - 2 ton/h Commercial scale: > 2ton/h)	Full integration (pre-treatment, torrefaction, combustion, heat cycle, densification)	Status
Clean Electricity Generation (UK)	Oscillating bed	Derby (UK)	30,000	Commercial scale	Yes	Available/operational
Horizon Bioenergy (NL)	Oscillating belt conveyor	Steenwijk (NL)	45,000	Commercial scale	Yes	Dismantled
Solvay (FR) / New Biomass Energy (USA)	Screw reactor	Quitman (USA/MS)	80,000	Commercial scale	Yes	Available/operational
Topell Energy (NL)	Fluidised bed	Duiven (NL)	60,000	Commercial scale	Yes	Mothballed
Torr-Coal B.V. (NL)	Rotary drum	Dilsen-Stokkem (BE)	30,000	Commercial scale	Yes	Available/operational
Airex (CAN/QC)	Cyclonic bed	Bécancour (CAN/QC)	16,000	Demonstration scale		Available/operational
Agri-Tech Producers LLC (USA/SC)	Screw reactor	Allendale (USA/SC)	13,000	Demonstration scale	Yes	Scheduled to be built
Andritz (AT)	Rotary drum	Frohnleiten (AT)	10,000	Demonstration scale	Yes	Out-of-service
Andritz (DK) / ECN (NL)	Moving bed	Stenderup (DK)	10,000	Demonstration scale		Unknown
BioEndev (SWE)	Dedicated screw reactor	Holmsund, Umea (SWE)	16,000	Demonstration scale	Yes	Available (2015)
CMI NESA (BE)	Multiple hearth	Seraing (BE)	Undefined	Demonstration scale		Unknown
Earth Care Products (USA)	Rotary drum	Independence (USA/KS)	20,000	Demonstration scale		Available/operational
Grupo Lantec (SP)	Moving bed	Urnieta (SP)	20,000	Demonstration scale		Unknown
Integro Earth Fuels, LLC (USA)	Multiple hearth	Greenville (USA/SC)	11,000	Demonstration scale		Unknown
LMK Energy (FR)	Moving bed	Mazingarbe (FR)	20,000	Demonstration scale		Unknown
River Basin Energy (USA)	Undefined	Laramie (USA/WY)	Undefined	Demonstration scale		Available/operational
Teal Sales Inc (USA)	Rotary drum	White Castle (USA/LA)	15,000	Demonstration scale		Available/operational
Torrec (FI)	Moving bed	Mikkeli (FI)	10,000	Demonstration scale		Available/operational
Agri-Tech Producers LLC (US/SC)	Screw reactor	Raleigh (USA/NC)	Undefined	Pilot stage		Available/operational
Airex (CAN/QC)	Cyclonic bed	Rouyn-Noranda (CAN/QC)	Undefined	Pilot stage		Available/operational
Airex (CAN/QC)	Cyclonic bed	Trois-Rivières (CAN/QC)	Undefined	Pilot stage		Available/operational
Arigna Fuels (IR)	Screw reactor	County Roscommon (IR)	Undefined	Pilot stage		Available/operational
CENER (SP)	Rotary drum	Aoiz (SP)	Undefined	Pilot scale		Available/operational
Terra Green Energy (USA)	Multiple hearth	McKean County (USA/PA)	Undefined	Pilot scale		Available/operational
Wyssmont (USA)	Multiple hearth	Fort Lee (USA/NJ)	Undefined	Pilot scale		Unknown
CEA (FR)	Multiple hearth	Paris (FR)	Undefined	Laboratory scale		Available/operational
Rotawave, Ltd. (UK)	Microwave	Chester (UK)	Undefined	Laboratory scale		Unknown
Bio Energy Development & Production (CAN)	Fluidised bed	Nova Scotia (CAN/NS)	Undefined	Unknown		Unknown

In the sections below, more detailed information is provided for a number of these companies, based on bilateral contacts. These companies have various states of development and experience (scale, run hours, production) with completely integrated systems (milling, drying, torrefying, densifying).

4.1 TORR-COAL GROUP

Torr-Coal was established in 2005 to start the research and development activities for her torrefaction technology. In 2009 the company has built her first torrefaction plant on an industrial scale in Dilsen-Stokkem (B) which started production in the last quarter of 2010. Recently the Group started with her new shareholder the roll-out of her technology. The company is headquartered in Sittard, the Netherlands.

Torr-Coal has developed their own torrefaction process which is based on a rotating drum reactor. Torr-Coal has built a torrefaction installation in Dilsen-Stokkem (Belgium) with a production capacity of 30 kton/a (4 ton/h), with wood as feedstock. The torrefaction installation applies a rotating drum. In 2011, 2012 and 2013, the plant produced torrefied biomass (powder). The (powder) product has been applied as co-firing fuel in a powder coal fired CHP plant and entrained flow gasification installation on a continuous basis. As feedstock, a mixture of deciduous and coniferous woodchips (according ISO 17225-1: 1.1.1.5 blends and mixtures of whole trees without roots) was applied.

In the meanwhile, Torr-Coal has also installed a pellet mill (1 ton/h) and produces 6 mm pellets with that pellet mill. The reason for choosing a 6 mm pellet mill was its availability. In 2015 Torr-Coal Group will start the production of bio-coal based on SRF as feedstock. The Torr-Coal Group has developed a special technology for this purpose and patented this technology worldwide.

In March 2015 A. Hak Renewable Energy became a major shareholder of the Torr-Coal Group. This step entirely fits into A. Hak Renewable Energy's objective of contributing to a 'bio-based economy'. She will take on the role of being an EPC partner in the process of creating installations on locations with an abundance of biomass.



Figure 4-3 The torrefaction demonstration plant of Torr-Coal in Dilsen-Stokkem

4.2 TOPELL ENERGY BV

Topell Energy is a privately funded Dutch clean technology company that has developed a patent-protected process for the torrefaction of biomass. The company was established in 2008, with its headquarters in Hoofddorp, the Netherlands. Topell Energy has less than 10 employees, all of them dedicated to torrefaction.

Topell Energy applies a fluidized bed technology. The technology is proven at a commercial scale demonstration plant in Duiven, The Netherlands. This plant was built in 2010 and commissioned in 2011. In 2012 the first product was produced and tested in several power plants. However, the plant was not operating at its design capacity. In the first half of 2013 Topell Energy implemented a redesign and in the second half of 2013 the plant was re-commissioned and ramped-up to its designed production capacity.

In a consortium together with utilities RWE, Vattenfall and GDF SUEZ, Topell Energy also completed a large scale co-firing test in the Amer 9 power plant of RWE Essent in the Netherlands. According to Topell, this test proved that Topell's pellets can replace coal in pulverized coal power plants, without the need for infrastructural changes at the power plant.

Topell Energy has postponed the production at its demo plant in September 2014, due to the absence of a new co-firing support system for biomass in the Netherlands. The plant is currently mothballed.

Topell's technology has been recognized as a breakthrough technology which enables large scale deployment of a biobased economy. The company has received awards from the Cleantech Group, the World Economic Forum, Bloomberg New Energy Finance, the World Wildlife Fund and others.



Figure 4-4 The torrefaction demonstration plant of Topell Energy in Duiven, the Netherlands (photo courtesy of Topell Energy)

4.3 SOLVAY BIOMASS ENERGY

Solvay Biomass Energy is a renewable energy company that specializes in developing and operating torrefied wood pellet facilities. It has been established in 2014 and is located in Houston, Texas, USA.

Solvay Biomass Energy is a joint venture between Solvay Energy Services and New Biomass Holding. New Biomass Holding a green energy developer that developed and operates the wood torrefaction facility in Quitman, Mississippi.

Solvay Biomass Energy (SBE) has approximately 45 employees, including the ones at the BTH Quitman Hickory plant, with all of them dedicated to torrefaction.

SBE has been created with the aim of developing torrefied products and develop, invest and operate new torrefaction production facilities. Solvay brings the industrial expertise of a multinational chemical company.

The Quitman plant has been expanded to increase the torrefaction and white pellet capacity in order to produce high energy pellets. From 2012 publication, two 2nd generation torrefaction reactors have been implemented and put into operation at Quitman plant.



Figure 4-5 The torrefaction reactor of Solvay Biomass Energy



Figure 4-6 One of the hot oil systems at the Solvay Biomass Energy plant

4.4 TEAL SALES INC.

TSI Incorporated was established in 1992 and has its headquarter in Lynnwood, WA, USA. The company has around 100 employees, but none of them is 100% dedicated to torrefaction. TSI is already very active in the biomass to energy industry as a supplier of rotary drum dryers, furnaces and pollution control equipment to industrial wood pellet and bioenergy plants and has supplied major equipment to large biomass processing plants.

TSI started a torrefaction development program based on its dryer technology in 2010. Essentially the approach was to build a dryer that would exclude oxygen. TSI started with a pilot unit close to the office in Lynnwood and used this for about three years to develop and optimize the technology. The resulting technology has received full patent protection in the US and patents have been applied for in other major markets around the World.

The process comprises a rotary drum with drop box, cyclones and a gas duct system and fan, much like a conventional dryer. The gas stream however is in a closed-loop and it is heated via a heat exchanger. Excess torrefaction gas is bled off and used as fuel in the heat energy system. The design is intended to be coupled with a dryer, therefore the feedstock is pre-dried before being torrefied.

Currently TSI has one operating system with about 2 ton/h capacity at a sugar mill in White Castle, Louisiana. TSI has delivered the dryer, torrefier and cooler. TSI is in the process of building a 250,000 ton/a plant for the same client, at the same location. Multiple other projects are under active discussion.



Figure 4-7 Rotary drum torrefaction island delivered by TSI.

4.5 AIREX ENERGY

Airex Industries was established in 1975 as a designer, manufacturer and installer of specialized equipment in the industrial sector, including dust collectors, industrial ovens and ventilators. Airex Energy (established 2014) is a spinoff of Airex Industries and it is specialized in the design and manufacturing of torrefaction/carbonization equipment for torrefied biomass and biocoal. Airex Energy has 5 employees and is located in Laval, Qc. Canada. Primary goal of the company is to sell torrefaction equipment (own design/engineering) rather than working on an EPC basis or becoming a large producer of torrefied material.

Airex has started about 5 years ago with an internal research and development program on torrefaction. This resulted in development of CarbonFX technology. The current torrefaction facility with 250 kg/h input biomass capacity is located in Rouyn-Noranda, Qc, Canada. It has been in operation since March 2011 and has until now over 2,500 hours of operation. A second unit with a capacity of 125 kg/h input biomass has been installed in March 2015 at the research center Innofibre in Trois-Rivières, Qc, Canada.

The CarbonFX process includes two-stage drying using hot flue gas. Torrefaction takes place in cyclonic reactor with torrefaction time of couple of seconds at temperature ranges between 290 – 365 °C. The volatiles are converted to heat in the combustor and the resulting heat is used to dry the biomass. The CarbonFX reactors are said to be compact, scalable (multiple reactors in parallel) and allows for the production of a wide range of products, from lightly torrefied material to highly carbonized biocoal.



Figure 4-8 Cyclonic reactor and combustor of the Airex installation.

In the course of 2014, Airex has been successful to raise \$10M to build a demonstration plant with a capacity of 2 ton/h in Becancour, Qc. Canada. Plant construction has been completed and operation has started in October 2015.



Figure 4-9 Airex demonstration plant, Becancour.

4.6 RIVER BASIN ENERGY

River Basin Energy (RBE) was established in 2008 and has its headquarters in Denver, Colorado, USA. It has less than 20 employees, all of them being dedicated to torrefaction.

RBE currently operates a demonstration plant in Laramie Wyoming, USA.

RBE will build a bio-coal production facility within the largest terminal for coal and iron-ore in Europe, operated by the Europees Massagoed Overslagbedrijf (EMO).



Figure 4-10 River Basin Energy torrefaction facility at the Western Research Institute

4.7 ARIGNA FUELS

Arigna Fuels was established in 1984 it is headquartered in Arigna, County Roscommon, Ireland. It has 55 employees of which 4 are dedicated to torrefaction. Arigna Fuels is a family business dedicated to the production of quality smokeless fuels to the domestic market in Ireland and the UK.

Arigna selected torrefaction as their preferred biomass thermal conversion technique as the products have a similar energy density and heating value as their existing branded product range (Ecobrite and Cosyglo), with improved environmental credentials compared to mineral solid fuels, but also reduced emissions when compared to wood fuels for domestic heating. Also a reduction in carbon tax is anticipated for thermally processed biomass fuels in Ireland.

The company in association with Enterprise Ireland has built a torrefaction plant based on a highly modified screw auger design, with indirect heating from thermal oil.

Arigna has already a pilot reactor in operation and it has recently been in the process of constructing a demonstration facility. As of October 2014 the torrefaction plant is in the commissioning stage and it is said to be capable of processing a wide range of biomass types. The research/ QC laboratory is equipped for fuel analysis and characterization.

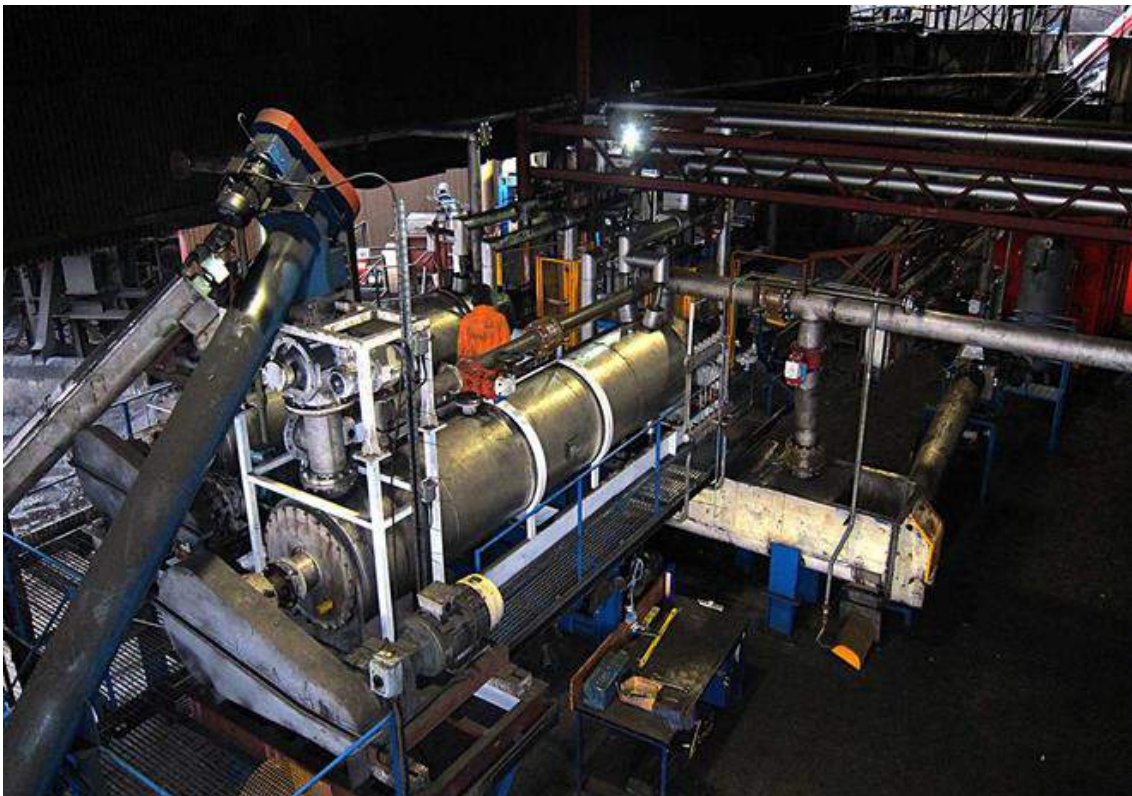

Figure 4-11 Modified screw reactor of Arigna Fuels.

4.8 EARTH CARE PRODUCTS INC.

Earth Care Products, Inc. (ECP) is located in Independence, Kansas and has been in business of designing and supplying industrial processing, dehydration and combustion equipment for biomass since 1992. The total number of employees is 12 of which at least 6 employees are dedicated to torrefaction. Earth Care Products Inc. provides solutions for industrial dehydration and biomass densification systems with its patented Z8 Rotary Dryers, combustion systems, material handling and state-of-the-art control systems. It provides Engineered Biomass Solid Fuels through its proprietary torrefaction systems and ACTOF® (Ablazing Clean Torrefied Organic Fuel).



Figure 4-12 Earth Care Products Inc.

ECP's mobile torrefaction system has a production capacity of 60 ton/d or 20,000 ton/year and future plans for scaling up includes fixed plants up to 18 - 19 ton/h capacity. The ECP proprietary torrefaction process consists of three main stages: drying, torrefaction and cooling. During the drying, the biomass feedstock less than 1/4" thick by 1.5" X 1.5" and around 40% moisture content are fed into the direct convection type Z8 Rotary Dryer. The heat for the dryer is supplied by the Biomass Burner which is a vertical dry cell biomass-fired burner. Turbulence created within the dryer leads to efficient and uniform drying of biomass chips at 3% to 4% moisture content and around 120°F to 130°F.

The torrefaction process involves a rotary drum with a small angle of positive inclination. The drum rotates within an insulated shell through which the hot gases flow by means of an induced draft. Torrefaction temperature is maintained within the torrefaction reactor without air flows inside the reactor, which ensures an oxygen-starved environment. The biomass undergoes devolatilization and small amount of mass loss owing to the VOC's released. The VOC's generated are conveyed back to the Biomass Burner where they are incinerated. The hot gases providing heat to the reactor by conduction is conveyed to the dryer thus minimizing heat loss and improving the process efficiency.

The torrefied biomass is then transferred to the airtight cooling stage. The cooler consists of a screw conveyor held inside a continuously-circulated water jacket. Water at ambient temperature is circulated through the jacket. Once the torrefied biomass is cooled to required temperature, it goes into a densification unit to increase its bulk density by 50% to 75% in pounds per cubic foot. Size and shape of densified product can be tailored to shipping and storage needs.

4.9 TORREC

The company Torrec Oy is established in 2013. Torrec Oy is a private company with 3 employees, which has been established to develop and commercialize the torrefaction technology based on the ideas of main shareholders.

The process technology of Torrec is based on the long experience of the main partners in three different areas:

- 1) thermal modification of sawn lumber (so called Thermowood process)
- 2) chip handling in pulp & paper processes and
- 3) pelletizing of by-products of thermally modified wood (mainly shaving and saw dust).

In 2014 Torrec Oy realized a demonstration project in Mikkeli, nominal capacity of which is about 1 ton/h and the total cost of the plant has been about 1.5 M€. The demo plant has been in operation since August 2014 and has proved the potential of the technology.



Figure 4-13 Torrec torrefaction facility.

4.10 TERRA GREEN ENERGY

Terra Green Energy (TGE) is a renewable fuels technology development company specifically focused on the development of a biomass pre-treatment technology called torrefaction. TGE was organized in 2009 by ARB, the majority owner of Terra Green Energy, LLC (TGE). ARB is a private investment firm that invests in environmental opportunities including companies, funds and public-private partnerships in the renewable energy, water, sustainable agriculture, and waste to value sectors.

TGE has designed and constructed a small scale torrefaction demonstration facility located in McKean County, Pennsylvania, USA. Commissioning commenced in the fall of 2014. The demonstration unit, with an output capacity of approximately 12 tons per day, includes an initial grinding step for pre-sizing the raw, green biomass followed by a pre-drying step by rotary drum dryer to reduce moisture to between 12% and 15%, a shaker/screener for removal of foreign materials which cause elevated ash in the finished product, a proprietary torrefaction reactor, and a biomass combustion unit to supply heat for both pre-drying and torrefaction. In addition, the biomass combustion unit insures the complete destruction of the torrefaction gases and recovery of its heat content.

TGE's torrefaction technology has been specifically designed in capacity and flow for use in or near the sources of biomass. The system's design, which allows it to operate without fossil fuels, is specific for smaller sized torrefaction locations with an ability to operate efficiently on a wide range of forestry residues, waste wood products, and on-purpose grown woody energy crops. Each unit will possess an output capacity in the range of 60,000 to 100,000 tons per year. Utilizing a 'distributive model' approach where multiple facilities across a region draw biomass from relatively short distances minimizing transportation costs without loss of production efficiencies.

Terra Green Energy's torrefaction technology is said to offer the following characteristics:

- Based on vertical, multiple hearth technology, which is mentioned by TGE as a viable technological approach to torrefaction, and has been applied by others
- The TGE technology is based upon a proprietary reactor design
- No fossil fuels used at any point or at any time in the TGE process
- Ability to utilize very low value biomass fuels as supplemental fuel such as bark and woody waste materials
- With a small footprint and cookie cutter reproducible design made multiple units across a geographical region viable
- Low manpower requirement as the entire system can be operated by one (1) operator in the computerized control room, one (1) process employee, and one (1) material handler
- Focused on niche market in or near forestry communities where sustainable quantities of renewable biomass are located
- Thousands of potential viable sites given the need for only 200,000 green tons per year and that these volumes can come for a combination of sources of forestry materials and on-purpose grown energy crops such as hybrid willow
- Low operating cost given low horsepower requirements for sizing and that no fossil fuels are used at any point or at any time in the process
- Fully integrated unit both thermally and control system
- Capable of processing both forestry materials and on-purpose grown woody bio-crops given the inclusion of a system for the proper pre-sizing all materials prior to entry into the torrefaction system followed by a subsystem for the mechanical removal of ash generating materials



Figure 4-14 TGE Torrefaction Reactor System.

5 Challenges for market implementation

This chapter summarizes the key findings from a consultation round that was performed by DNV GL among torrefaction technology developers. The information round focused on technological and legislative challenges for market implementation of torrefaction technologies that these companies faced. The results are based on answers of 11 technology developers.

5.1 LIMITED STAFF DEDICATED TO TECHNOLOGY DEVELOPMENT

Many companies that try to develop a torrefaction technology are relatively small, which makes it difficult to achieve progress rapidly. The staff dedicated to torrefaction varies from none to 45. A typical figure for operating a 30 - 50 kton/a facility, including overhead, is 10-15.

5.2 FEEDSTOCK FLEXIBILITY

Most of the torrefaction technology developers have tested different feedstock types in lab scale plants. However, demonstration scale facilities are typically using wood derived products (of varying qualities). Some demonstration facilities apply relatively low quality feedstock (including bark) mainly resulting from the high cost barrier of clean wood chips. At least one installation applies agro-residues (trash from sugar cane) at a (semi)-continuous scale and as only feedstock.

The use of agro-residues with low bulk density such as hay or straw requires larger reactors compared to woody biomass, which leads to increases in capital cost and operational difficulties. As the fuel flexibility of most torrefaction reactors is limited in terms of biomass sizing, density and moisture content, proper pre-treatment (minimizing, drying, sieving) is typically required. Therefore, biomass pre-treatment is typically designed for a specific feedstock type.

Typical input particle size is 5 to 20 mm and the moisture content of input material for the reactor must not exceed a value of 15% to avoid incomplete combustion of the torrefaction gases and to minimize the process residence time. In addition, varying moisture content at the reactor inlet complicates process control.

New innovations are ongoing that further combine torrefaction with innovative biomass treatment processes like washing out of salts.

5.3 TREATMENT OF TORREFACTION GASES

The torrefaction gases released from the torrefaction process consist of CO₂, CO and various organic compounds such as acetic acid, formic acid, methanol, phenols, furfural and other light organics, see Figure 5-1.

Volatile yield by torrefaction of willow

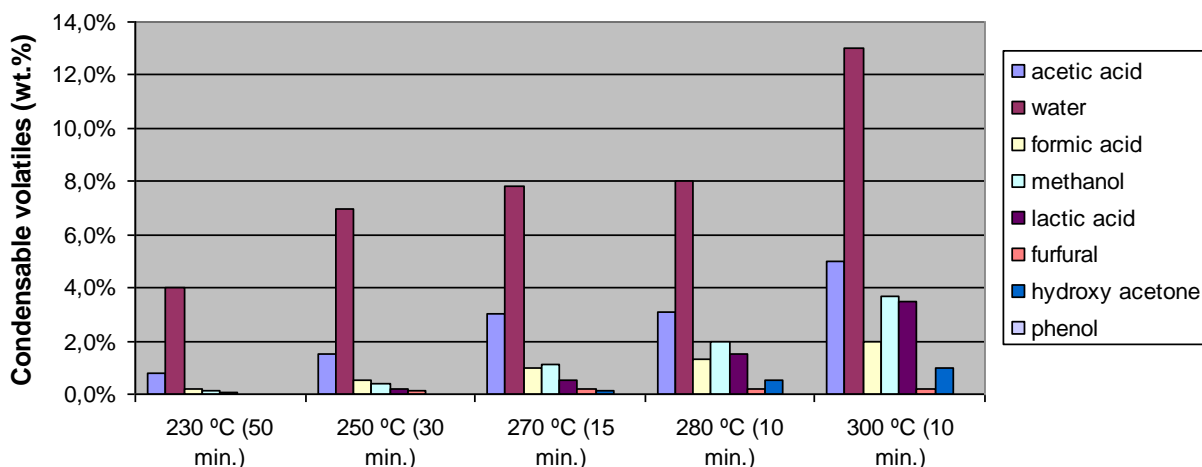

Figure 5-1 Composition of volatiles released during torrefaction of willow at different temperatures (Prins, 2005)

The torrefaction gas is normally de-dusted using a cyclone, before being used as a fuel to dry incoming biomass. More heavy tars present in the torrefaction gas may condense in the ducts upstream of the burner, resulting in operational problems. For this reason torrefaction gas ducts need to be insulated.

All main developers reuse the torrefaction gas by means of combustion in a separate combustion unit. The heat from the flue gas leaving the combustion unit is then used in the process and circulates through the dryer to dry the wet biomass directly or indirectly.

For proper operation of the torrefaction gas burner, sufficient residence time, mixing with combustion air and flame temperature (>900 °C) are required. NO_x emissions are generally low due to the modest combustion temperature of the gas.

In case substantial amounts of F, S or Cl are present in the feedstock, treatment of the burner flue gases using an active carbon filter or wet precipitator may be required. For clean biomass fuels however, a dust filter may be sufficient. This however depends on the exact layout and the temperature of the flue gas (possibility of fire).

5.4 PERSPECTIVES ON PROCESS UPSCALING

Depending on the reactor type, it can be a serious challenge to scale up a torrefaction processes from pilot (typically 20-600 kg/h) to commercial scale (5-10 ton/h or larger). Developers have different approaches to scale-up. Some apply modular trains with typical production capacities that are in the range of 3-6 ton/h, while others scale to a higher or even very high (>30 ton/h) reactor capacity.

In case of screw reactors, moving bed reactors or belt conveyors, the limited scalability will often require multiple production lines in parallel. For example, a scaled up moving bed might lead to the unwanted "tunnel" effect, resulting in an uneven heat distribution over the reactor. When scaling up a screw reactor, the ratio between screw surface area and reactor volume decreases, resulting in efficiency loss. For a drum reactor the scalability is somewhat uncertain. Originally it was thought that scalability for drum reactors was limited and a modular set-up should be required. Larger rotary drum reactors are not yet available for torrefaction; however, as they are

available for drying, there are indications that there might still be some potential for application in torrefaction processes. This needs to be proven.

5.5 PROCESS CONTROL

The control of the temperature profile and residence time of the solid biomass during the torrefaction process is crucial for an efficient process and optimal product quality. The ability to control these parameters varies between the different torrefaction concepts.

To enable operation the torrefaction plant on a continuous basis, lessons learned are to be implemented. Issues that have been solved by several developers include leakage of seals and failure of equipment.

5.6 PRODUCT QUALITY/CONSISTENCY

In all cases, a well-controlled biomass particle size and composition (usually clean wood) leads to better process controllability and product quality. When switching to other feedstock, obtaining adequate process controllability may become an issue.

The consistency of the product is often a challenge; as the torrefaction process involves many parameters, like uneven biomass quality, heat transfer rate, reactor temperatures, residence time, particle size distribution, thermal properties of the biomass material, it appears still a challenge to obtain a well-defined homogeneous product. A typical range of +/- 2 MJ/kg in the end-product may be allowed for. Nevertheless, only 2 out of 11 respondents see product quality as a major restriction for successful entry of torrefied biomass in the market.

5.7 DENSIFICATION AND PELLET DURABILITY

Densification is important as it optimizes product properties in terms water resistance, durability and the use of binders: what are the best conditions to produce a product that meets criteria for handling properties. Most of the developers have included biomass densification in their torrefaction plant layout over time. Some, however, have included densification earlier in the development trajectory than others.

Research in SECTOR showed that in spite of the hydrophobicity of individual biomass particles that are torrefied, torrefied biomass that is not properly densified to a high durability pellet, may seriously deteriorate when exposed to rain. This is attributed to surface cracks which allow water to enter the particle and deteriorate the mechanical quality (e.g. through freeze-thaw cycles). Another problem with pellets of too low mechanical durability is dust formation during handling, which may cause health and safety related problems (e.g. dust explosions). Densification of torrefied biomass has significantly improved over the last 2-3 years due to a better understanding of the relation between biomass characteristics, torrefaction process conditions, and densification process parameters. This is also confirmed by the SECTOR project, where pellet durability has increased to levels exceeding 97%.

Table 5-1 Optimization of mechanical durability of torrefied pine and straw pellets at CENER (SECTOR, 2015)

Date	Durability	Pine	Date	Durability	Straw
October 2012	88.8		February 2013	84.2	
January 2013	92.3		September 2013	94.3	
June 2013	94.7		October 2013	96.6	
November 2013	95.7		November 2013	97.6	

There is currently no standard size for torrefied biomass. Some developers apply 6 or 8 mm presses, whereas others have chosen for briquetting (extrusion or egg-shaped).

Some developers mentioned that it took a few years in order to have the densification process under control, such to ensure a more or less constant product quality.

5.8 HEALTH AND SAFETY (HSE)

Torrefied biomass has the tendency to be brittle. The dust can be very fine and is difficult to capture with a water spray. Smouldering of biomass in torrefaction installations has happened and in at least one case a fire was caught in a silo that contained torrefied biomass. However, from all developers that responded to our request only 2 out of 11 indicated that HSE would be a major restriction for successful entry of torrefied biomass in the market.

6 Recommendations

The above mentioned challenges for accelerated market implementation can be addressed in several ways by either market or government organizations. This section provides some recommendations.

6.1 PRODUCTION SCALE UP

9 out of the 11 respondents indicated that production scale up is one of the most important challenges to enable torrefied biomass being competitive with white wood pellets.

The optimal approach for a commercial torrefaction installation in terms of size, torrefaction degree, etc. depends on several technical and economic factors, such as the type of feedstock available, requested product specifications, technical design limitations of the reactor technology, the achievable degree of process control, options for heat integration and emissions. Economic aspects include the cost of biomass, cost of pre-treatment, mass loss of product during torrefaction, achievable process throughput and product sales price. Understanding and developing the optimal combination of these factors requires time and money. At the same time, the first commercial clients typically request product in quantities which easily require up-scaling of an available pilot plants by typically a factor of 100. In order to limit the risks and the development effort in debottlenecking while scaling up, the first commercial installations are currently designed for using clean biomass.

Some initiatives have realized demonstration scale facilities, whereas others are still working on pilot scale. It is crucial that developers succeed in upscaling their technologies to full industrial scale facilities that will be able to serve large utilities with substantial amounts of pellets. As this is a difficult step in terms of financing and risk management, a number of developers are re-focusing on the market and now consider smaller consumers to become the primary off-takers for torrefied biomass on short term. These customers require smaller quantities of fuel, which better complies with current capacities of demonstration plants.

The total cumulative torrefied product quantity that has been produced is estimated at 70-120 kton thus far. This is very limited compared to the cumulative claimed nameplate production capacity which exceeds 200 ktons/year (see table 4-1). It can thus be concluded that the claimed production capacity is not fully utilized.

6.2 END USER CONFIDENCE

End-users were originally anticipated to be large coal firing utilities. In Europe (EU 28) alone, 285 Mt of hard coal and 421 Mt of lignite were consumed in 2014 [33], An average co-firing share of 10% would result in a European market of approx. 70 Mt per year. Nevertheless, market conditions (e.g. CO₂ prices, needed amounts) and chosen lock-in solutions from potential co-firing customers (that have already invested to accommodate white pellets) require a careful policy approach to support market introduction. Important factors here are the CO₂ emissions and possible savings, and the economic aspects for different end-user markets. In countries where the interest in biomass cofiring is just starting (e.g. South Africa, Japan, Korea), opportunities for cofiring torrefied biomass could be more attractive.

In addition, the expectations raised by the torrefaction industry around 2010 have not yet been met. The torrefaction industry has failed to demonstrate both economic and technical viability of torrefied biomass fuels in comparison to white wood pellets, and customer confidence along the

supply chain is urgently needed. This includes benefitting from the enhanced product specifications compared to white pellets. Small scale customers however may require agreement from their boiler producers to regard biocoal as a technically acceptable fuel for reasons of warranty. Research in SECTOR has shown that some adaptations to boiler technology are required in order to optimally accommodate torrefied fuels.

Most of the torrefied product available today from the torrefaction technology developers is used for lab tests (9 out of 9 respondents) and at coal plants (6 out of 9 respondents). These co-firing trials typically range from 1,000-3,000 tons, but there are also few examples of continuous use in a coal plant. Additionally, tests have been performed in a (coal) gasifier (4 out of 9 respondents), boilers smaller than 1 MWth (4 out of 9 respondents) and used for further upgrading (4 out of 9 respondents).

6.3 LOWER PRODUCT PRICE

6 out of the 11 respondents indicated that a lower product price is one of the most important aspects to enable torrefied biomass being competitive with white wood pellets.

The main driver for development of torrefaction technologies is the anticipated commercial returns. In the negotiations of prices between the most important off-takers (energy companies) and the torrefaction companies, uncertainties about milling behaviour, combustion behaviour, storage aspects, self-heating and safety aspects play an important role. As a result, there is uncertainty about potential cost savings at the power plant, which lowers the price benefit for the fuel. While R&D work is ongoing for smaller scale experimental work (e.g. in the areas of milling and combustion characteristics), additional full scale co-firing trials of multiple days should be performed to test the handling and storage behaviour, for a single test at least 5,000 tons will be needed.

It is obvious that many developers are struggling to bring their initiative to the next level. The financing for this next level is often closely related to a (missing) contract for guaranteed off-taking of the torrefied material for a significant period of time. The chicken-and-egg analogy is still applicable. Diversification to other end user markets is considered by some developers to assist in resolving this issue.

6.4 PRODUCT STANDARDS

Only 1 out of the 11 respondents indicated that a product standard is one of the most important aspects to enable torrefied biomass being competitive with white wood pellets. However 5 out of the 11 respondents indicate that not having a product standard is a major restriction for a successful entry of torrefied material in the market.

In order to accelerate the market for torrefied products, end users should obtain sufficient confidence in the quality of the products procured. Product standards are under development for increasing transparency between producers and end users and for the use of product to gain acceptance in the market.

Current standards for biomass often do not include the option of torrefied products. It is known that in this situation, end users set unreasonable product standards which can hardly be met by the producers. It is therefore important that torrefied products are properly included in existing harmonization efforts for new CEN, ISO and national standards, where the various product quality specifications are defined through constructive interaction between producers and end users of the material.

Currently ISO TC 238/WG 2 is working on a product standard: Solid biofuels - Fuel specifications and classes - Part 8: Graded thermally treated and densified biomass fuels. This product standard will include industrial and non-industrial use.

6.5 STANDARDS FOR SUSTAINABILITY AND TRACEABILITY

In order to benefit from the reduced logistical costs of torrefied material, it is likely that torrefaction installations will be built in areas with large biomass resources. The upcoming ISO 248 sustainability standard for bioenergy which covers the entire supply chain therefore needs to include torrefied materials.

With regard to various sustainability standards, the ISO 248 standards under development for 'Quality Control and Quality Assurance' will form the basis for traceability. After torrefaction, the origin of the biomass used is difficult to identify, particularly when biomass from multiple sources is torrefied in the same process. This would imply that administration of resources and products need to be accurately performed and this is where international product certification standards will play a role.

6.6 TORREFYING WASTES

In the past few years, torrefaction of waste has not been a major topic for torrefaction developers. The main focus with respect to feedstock was on wood (chips) and to certain extends on agro-residues. However, some recent research indicated that through the torrefaction process, a significant amount of chlorine (up to 90%) can be removed from the original biomass(Keipi). This would imply that chlorine related corrosion impacts can be significantly reduced through the torrefaction process.

7 Conclusions

Torrefaction significantly improves the suitability of biomass for co-firing in coal fired power plants and has the potential to enable higher co-firing percentages at reduced cost.

7.1 RECENT TECHNOLOGY DEVELOPMENT

The maturation and market introduction of torrefaction technologies has gone slower than anticipated 5 years ago, when it was expected that a significant fraction of the biomass pellets supplied today could have been replaced by torrefied pellets. It has been hard to fully prove the claims made earlier on product characteristics, and several companies have gone bankrupt due to inability to produce good quality product or due to a lack of buyers. The average score in the questionnaire on achievement of success in technology development was a 5.7 out of 10.

As of 2015 however, some important progress can be observed. The torrefaction technology has been proven on pilot scale and a number of demonstration and (semi)commercial facilities have been realized. The companies involved have significantly improved their ability to produce high quality products, with pellets of comparable durability to conventional wood pellets. The torrefied pellets exhibit comparable supply costs, however for the end user it provides superior handling and combustion characteristics. Total cumulative production figures are estimated at 70-120 ktons of torrefied product to date. The product has been used in coal plants, gasifier(s) and non-industrial facilities, although in very few cases for an extended period of time. Some developers, however, have re-focused on the market for torrefied material: they consider smaller domestic or industrial markets more promising than large scale utilities.

The most important technical challenges in the development of torrefaction processes relate to achieving constant and well controlled product quality, scaling up the process and product densification. Most progress has been made on the ability to densify the material to a durable pellet or briquette which can be handled without generation of large amounts of highly explosive dust, although few developers have produced significant amounts (>10 ktons) of torrefied pellets or briquettes yet. Although demonstration and (semi)commercial facilities are running now, finding the optimal process conditions for producing a stable and high quality end-product are ongoing.

Around 150 universities, research institutes and companies have published scientific documents (articles & conference proceedings) since 2002, totalling over 450 scientific documents, most of them from the United States. Most of the R&D up-to-date is done with clean wood and the first demonstration scale installations are operated on woody biomass as well.

Torrefaction of agro-residues appears to be more complicated due to the challenging physical and chemical characteristics. This would only make it feasible to develop suitable torrefaction processes in case significantly lower prices for the input material can be secured. So far, the developments on using agro-residues are limited.

There are still a few dozen of torrefaction developers, although the ones with a (semi)commercial facility with a production capacity of some ten-thousands of tons per year are less than 10. Some developers have become less active in the field (sleeping), whereas there are also new entrants. A number of realization projects are in the pipeline, typically ranging up to 250,000 tons per year production capacity.

7.2 THE BUSINESS CASE

The economic benefits of the use of the product against wood pellets were evaluated in various studies [Koppejan et al, 2012; Koppejan et al , 2015]. Depending on production location (EU or Canada/US, resource supply distance, torrefaction plant size, product distribution distance in Europe and scale of the end user, the costs of delivery varies between 10-17 Euro per GJ, with comparable supply cost figures of torrefied and white pellets for the large set of permutations simulated. For longer transportation distances, the additional costs of the torrefaction process can be compensated by savings in transportation costs.

In addition, it is likely that the similarity to coal will enable higher co-firing percentages for torrefied pellets as compared to regular wood pellets (or even complete fuel switching), without significant modifications to a power plant.

The actual market price of torrefied pellets however is not determined by the cost price, but by product substitution value, including perceived risks. With low prices for coal and CO₂ penalties and a high perceived risk, there is limited willingness to pay reasonable prices for torrefied pellets. Only if significant commercial production starts up and trade volumes increase, a true market value of torrefied pellets or briquettes will be established.

In the past few years the (commercial) position of torrefied biomass against white wood pellets for application in large scale power plants has not improved. White wood pellet application in large power plants has achieved significant volumes and facilities that enable the use of white wood pellets are meanwhile considered proven technology. Further it is important to realize that there is only a real benefit if the associated investments for modifying a plant to enable the use of wood pellets can be avoided.

Moreover, the pressure on fuel costs in the power industry is huge. As a result, some developers are re-focusing on smaller scale applications for torrefied biomass. For these domestic or small industrial scale applications current fuel price levels may be more attractive to introduce torrefied biomass. In addition, these applications require smaller torrefaction plant capacities, making discussions with financiers easier.

7.3 POLITICAL AND LEGISLATIVE CONSTRAINTS

Price parity with coal is essential to enable commercial market introduction of torrefied biomass for cofiring. The relatively low CO₂ price is however a major hurdle for the business case, as the CO₂ penalty alone is insufficient to switch from coal to torrefied biomass. Although the EU tries to increase the market price of CO₂ by 'backloading EU emission allowances for CO₂, the actual effect is still limited for the time being. For this reason only in countries with additional cofiring support schemes (e.g. UK, Netherlands, Belgium), cofiring or 100% conversion could still grow significantly in the couple of years.

It is important that CO₂ emission allowances are tightened in order to increase CO₂ prices, and that additional support schemes are put into place by individual EU member countries to facilitate cofiring of (torrefied) biomass. Further, torrefied biomass needs to be accepted within regulatory frameworks. Currently, no clarity exists on fiscal subsidy schemes for torrefied biomass. The question is how it will be treated by governments and regulatory frameworks.

8 References

- Abelha P. and Biesbroek A., "D6.5 Report on dust explosion and emission risks," SECTOR, 2014
- Alakangas E., "D8.3 Graded thermally and densified biomass fuels Development of the ISO 17225-8 standard," SECTOR, 2014
- Bergman, P.C.A., 2005, Combined torrefaction and pelletization -The TOP process, ECN report ECN-C--05-073, 2005
- Ciolkosz, D., Wallace, R., A review of torrefaction for bioenergy feedstock production, *Biofuels, Bioprod. Bioref.* 5:317–329 (2011)
- Cruz Cebalos D.C., Hawboldt K., Helleur, R., Effect of production conditions on self-heating propensity of torrefied sawmill residues, *Fuel* 160 p227-237, 2015
- Gil, W. Stelte, P. Nanou, L. Pommer and M. Rudolfsson, "D4.6 Mass and energy balances of different densification concepts," SECTOR, 2014
- Gulik G. J. v. d., Koppejan J., Kakietek S., Burnham-Slipper H. and Quick W., "D7.8 Extrapolation of co-firing results to large scale boilers using CFD calculations," SECTOR, 2014
- Hoefl M., "D8.2 Requirements for a MSDS for torrefied material," SECTOR, 2013.
- ISO 17225-1 Solid Biofuels – Fuel Specifications and Classes – Part 1: General Requirements.
- Keipi T, Tolvanen H, Kokko L, Raiko R (2014) The effect of torrefaction on the chlorine content and heating value of eight woody biomass samples. *Biomass Bioenergy* 66:232–239.
- KEMA, 2008. Statusdocument Bio-energie 2008. In opdracht van SenterNovem.
- KEMA, 2010, Statusoverzicht en impactanalyse van torrefaction in Nederland, for AgentschapNL, report nr. 30920555-Consulting 10-0508
- KEMA, 2011: Overview of the European torrefaction landscape, Ronald Meijer, EPRI Biomass Torrefaction Workshop, April 13-14, 2011, Pensacola, FL, US
- KEMA, 2012a, Status of North American and European torrefaction initiatives, Presentation at the World Sustainable Energy Days 2012, Wels, Austria.
- KEMA, 2012b, Cracked biomass, Article submitted to *Renewable Energy World* magazine, April 2012
- KEMA, 2012c, Private Communications, April 2012
- Koppejan, J. 2009. Beschikbaarheid van Nederlandse biomassa voor elektriciteit en warmte in 2020. Nov 2009. SenterNovem.
- Koppejan, J., Sokhansanj, S., Melin, S., Madrali, S., 2012, Status overview of torrefaction technologies, Final Report, IEA Bioenergy Task 32, Dec 2012
- Koppejan J., 2014, "Development of torrefaction technologies and impacts on global trade, report of a workshop at the Central European Biomass Conference," IEA Bioenergy task 32, Jan 2014

- Koppejan J., 2015, Torrefaction Technology Report, SECTOR, Deliverable No. D10.2, 2015
- LAP2 (2009 -2021) (Dutch waste management plan), www.infomil.nl .
- Clara Huéscar Medina, Herodotos N. Phylaktou, Gordon E. Andrews, Bernard M. Gibbs, Comparison of explosion characteristics of torrefied and raw biomass, Univ. of Leeds, presented at European Biomass Conference, 2015
- Nanou P., Lemus J. and Pommer L., "D6.4 Final report on pellet characteristics after renewed tests with optimised torrefied materials," SECTOR, 2014a.
- Nanou P., Lemus J. and Pommer L., "D6.4 Analysis reports on self-ignition and exothermal behaviour," SECTOR, 2014b.
- Ndibe C., Vonk G., Maier J., Marek E., Biesbroek E., Vilela C. M., Kalivodova J., Carbo M., Livingston B., Nordin A., Strandberg M., Pommer L., Burman J., Wennström P., Khwaja and Salik, "D7.9 Milling, co-milling and feeding characteristics in co-firing and co-gasification," SECTOR, 2014
- NTA 8003. Classificatie van biomassa voor nuttige toepassing. Nederlandse Normalisatie Instituut.
- Prins, M.J. 2005. Thermodynamic analysis of biomass gasification and torrefaction. PhD Thesis. Technische Universiteit Eindhoven.
- Repellin, 2010, Energy requirement for fine grinding of torrefied wood, Biomass and Bioenergy 34 (2010) 923 – 930
- Schakel W., 2011, Economical analysis co-firing torrefied pellets in coal plants, University of Utrecht
- Stelte W., Dahl J., Nielsen N.P.K., Hansen H.O., 2012, Densification concepts for torrefied biomass, IEA Bioenergy Task 32 / Sector workshop, Milan, 2012
- Strandberg M., Olofsson I., Pommer L., Wicklund-Linström S., Åberg K., Nordin A., Effects of Temperature and Residence Time on Continuous Torrefaction of Spruce Wood, Fuel Processing Technology 134, 387-398, 2015
- Uslu A., Faaij A. P.C., Bergman P.C.A., Pre-treatment technologies and their effect on international bioenergy supply chain logistics. Techno-economic evaluation of torrefaction, fast pyrolysis and pelletization, Energy 33 (2008) 1206– 1223
- Vergunningsaanvraag Topell B.V. Locatie Duiven. Provincie Gelderland.
- Vergunningsaanvraag Stramproy Green Investment B.V. Locatie Steenwijk. Gemeente Steenwijkerland.
- Vergunningsaanvraag Torr-Coal. Locatie Dilsen-Stokkem. Provincie Limburg, België.
- Vahrenholt, F. Gassner, H. 2010. The Growth Strategy of RWE Innology –Role of RES in RWE's strategy. VGB PowerTech 2010.
- Yan, W., et al., "Thermal pretreatment of lignocellulosic biomass," Environ. Progress and Sustainable Energy 28 (3) 435-440 (2009).

IEA Bioenergy



Further Information

IEA Bioenergy Website
www.ieabioenergy.com
www.ieabioenergytask32.com

Contact us:
www.ieabioenergy.com/contact-us/