

Thomas Nussbaumer and Stefan Thalmann
Verenum, Zürich, Switzerland

Sensitivity of System Design on Heat Distribution Cost in District Heating

prepared for the

International Energy Agency IEA Bioenergy Task 32
and the
Swiss Federal Office of Energy

Zürich, 19 December 2014

ISBN 3-908705-27-4



Thomas Nussbaumer, Stefan Thalmann

Sensitivity of System Design on Heat Distribution Cost in District Heating

IEA Bioenergy Task 32, Swiss Federal Office of Energy, and Verenum, Zürich 2014

ISBN 3-908705-27-4

Distribution: www.verenum.ch

www.ieabioenergytask32.com

www.bfe.admin.ch/forschung/biomasse

Disclaimer: The present report has been prepared for the International Energy Agency IEA Bioenergy Task 32 (IEA) and the Swiss Federal Office of Energy (SFOE). IEA and SFOE do not accept any liability for the information contained in the report. All statements reflect the opinion of the authors and are not necessarily agreed to by the contracting authorities. All information has been compiled from sources believed to be reliable. Nevertheless, the authors and their organisations do not accept liability for any loss or damage arising from the use thereof. Using the given information is strictly your own responsibility.

Content

Abstract	5
1 Introduction	7
1.1 Advantages of district heating.....	7
1.2 Disadvantages and barriers for further implementation	7
1.3 Aim.....	8
2 History and current situation	9
2.1 District heating in IEA countries	9
2.2 Situation in Switzerland.....	10
3 Method	11
4 Assumptions	13
4.1 Parameters for economic assessment.....	13
4.2 Piping design	17
4.3 Model district heating system.....	19
5 Results	20
5.1 Heat distribution losses.....	20
5.1.1 Influence of the insulation class (Figure 8)	20
5.1.2 Influence of the temperature difference (Figure 9)	20
5.1.3 Influence of the full-load hours and as a consequence the linear heat density (Figure 10).....	22
5.1.4 Influence of the connection load and as a consequence of the linear heat density (Figure 11).....	22
5.2 Economic analysis	24
5.2.1 Share of the capital and operation cost (Figure 12).....	24
5.2.2 Influence of the interest rate (Figure 13).....	25
5.2.3 Influence of the fuel price (Figure 14)	26
5.2.4 Influence of the insulation thickness (Figure 14)	26
5.2.5 Influence of the electricity price (Figure 15).....	27
5.2.6 Influence of the supply temperature (Figure 16)	28
5.2.7 Influence of the temperature difference (Figure 17)	29
5.2.8 Influence of the full-load hours and consequently the linear heat density (Figure 18).....	30
5.2.9 Influence of the network length respectively the connection load (Figure 19 and Figure 20) ...	30
5.2.10 Diseconomy of scale and influence of layout (Figure 21, Figure 22).....	32
6 Conclusions	35
6.1 Methodology	35
6.2 Heat distribution cost	35
6.3 Network design	36
6.4 Sensitivity.....	36
7 Literature	38

T. Nussbaumer, S. Thalmann:

Sensitivity analysis of design parameters on heat distribution cost

IEA Bioenergy Task 32, Swiss Federal Office of Energy, Zürich 2014

Abstract

District heating (DH) offers interesting opportunities to use biomass and/or waste heat as energy source for thermal heat and thus to replace decentralised fossil heating. On the other hand however, district heating induces additional cost and energy losses at the heat distribution. The present project introduces a sensitivity analysis for a virtual DH network with 1 MW heat output, a pipeline length of 1 km, and a heat consumption during 2000 annual full-load hours corresponding to a linear heat density of 2000 MWh per year and meter of pipeline length (MWh/m a).

An economic assessment based on an annuity of 5.1 % p.a. (corresponding to an interest rate of 3.0 % p.a. for the calculation period of 30 years) reveals total heat distribution cost of 2.16 euro cent per kWh heat delivered to the consumers for an optimised pipe diameter, open field conditions and at prices valid in Switzerland. The total costs are clearly dominated by the capital costs representing a share of 62%, while the fuel costs at a fuel price of 4.0 c/kWh contributes with 25% and the electricity costs for pumping at a power price of 16.5 c/kWh with the remaining 13%.

With reduced linear heat density, as it is often found in non-urban areas, the capital cost increases further. An assessment of the connection load reveals that at constant linear heat density, the heat distribution costs increase with increasing network size. Consequently, strong economy of scale in the heat production is necessary to justify large DH systems. This pre-condition is typically fulfilled by automatic biomass combustion plants and even amplified for applications with combined heat and power (CHP).

Since the capital costs, which increase with the pipe diameter, dominate the total cost, the main design approach to minimise the heat distribution costs implies the use of the smallest, technically feasible pipe diameter without cavitation pitting. The smallest pipe diameter is related to the maximum allowable specific pressure drop for which typical values of 150 Pa/m to 200 Pa/m have so far been postulated by different plant planning guides and pipe manufacturers. Maximum values of 300 Pa/m are recommended, e.g. for thermal heat in housing, since the maximum pressure drop only occurs at a short peak time.

For the investigated model network, an oversizing by one diameter results in 9% higher heat distribution cost while two diameters cause 30% higher cost. Besides the pipe diameter, it is essential to exhaust the maximum temperature difference in the network and thus to obtain the lowest possible return temperatures. Furthermore although the highest insulation class is recommended, it has a minor influence on the economy and is economically not favourable at today's fuel prices.

Keywords: District heating, linear heat density, pipe diameter, pressure drop

1 Introduction

1.1 Advantages of district heating

District heating (DH) enables a comfortable way to use biomass for room heating and process heat [1]. Due to size reasons, low impact on air pollution can be achieved thanks to automatic combustion systems equipped with efficient particle precipitation. In addition, low-grade biofuels such as bark, wood residues, and urban waste wood may be used as energy carriers in systems of typical sizes for district heating applications and thus enable further propagation of bioenergy. Combined heat and power (CHP) is moreover an interesting option that is becoming even more interesting with increasing size due to economy of scale. Consequently, district heating systems (DHS) based on automatic wood boilers has received relevant policy support and has become more and more important in many IEA countries in the past twenty years [2].

1.2 Disadvantages and barriers for further implementation

Additional heat distribution losses and auxiliary energy consumption can significantly reduce the overall efficiency and the economic performance of district heating in comparison to decentralised heat production. Further, the network design and in particular the pipe diameter strongly influence the capital cost and heat distribution losses. Consequently, there is a potential to improve efficiency and economy by optimisation of the plant design and operation. Practical experience shows that the following factors may entail high losses and the non-compliance with the design specification [3]:

- Substations with low thermal efficiency¹ and excessive terminal temperature difference² [4].
- Consequently high return temperatures.
- Hydraulic integration of the domestic hot water warming.
- Dimensioning and design of heat generator and district heating network.

¹ The thermal efficiency of heat exchangers is described by the degree of heat transfer defined as the ratio between the transferred and maximally possible heat flow. The efficiency depends on the layout of the heat exchanger and its exchanger surface as well as on the operation parameters, especially the flow velocity and hence the mass flow rates of the fluids in a defined system.

² The terminal temperature difference is defined as the smallest temperature difference (ΔT) between the hot and cold medium. In practice, it is often almost independent of the absolute temperature level of the fluids. It appears at the so-called pinch point which is normally located at the inlet and outlet of a fluid in the case of simple heat exchangers without phase changed. Since the smallest achievable temperature difference is determined by the heat exchanger surface area, the terminal temperature difference represents a measure of the size and hence of the cost of a heat exchanger. In the case of substations with counter-flow heat exchangers, the terminal temperature difference corresponds to the difference between the DH sand the customer heating return temperature. A terminal temperature difference of less than 5 K is usually used as guideline implying a design with a smaller terminal temperature difference such as 3 K.

1.3 Aim

The aim of the present project is a sensitivity analysis of district heating systems that enables the evaluation of how main design and operation parameters influence the heat losses and heat distribution cost. For this purpose, a model network with typical parameters of non-urban DH systems supplied by automatic wood boilers is defined and assessed by variation of the main parameters. From these calculations, benchmark values for minimum heat distribution are determined at given boundary conditions and an estimation for the optimisation potential in comparison to existing district heating systems is derived thereof.

2 History and current situation

2.1 District heating in IEA countries

Already during the Roman Empire, thermal water from hot sources was distributed in surrounding buildings and used for bathing or to heat single rooms with underfloor heating. Today's DH systems were introduced by the end of the 19th century. The first known DH network was built in 1877 in Lockport (New York, USA) [5]. In the 20th century, Dh supply propagated quickly in Europe. Especially from the 1960s, district heating gained in importance in Denmark, Sweden, Germany, the Netherlands, Belgium, and Russia [1], [2], [6], (Figure 1).

Initially, fossil fuels were centrally burned and the heat was distributed by means of hot water or steam, whereas big DH networks were and still are mainly using waste heat from fossil-thermal power plants. In fact, coal-fired power plants feature waste heat capacities of several hundred megawatts that may be partially extracted for district heating. Later on, the waste heat recovery of municipal solid waste (MSW) incinerators and other sources became important as well. In principle, the waste heat recovery of nuclear power plants would also be worthwhile. However, it has only rarely been established partially supported by the unfavourable location of nuclear power plants far from urban and industrial areas.

Since 30 years, smaller DH networks with wood-fired heat generators as well as wood-fuelled CHP are increasingly implemented. The local provision for small supply areas are sometimes also defined as "local heat". In CHP plants, steam turbines with capacities between 1 MWe up to several 100 MWe are mainly used, whereas plants with smaller power ranges also operate with organic Rankine cycles (ORC). The use of biomass gasification technologies is also increasingly implemented for their potential in attaining higher electric efficiencies.

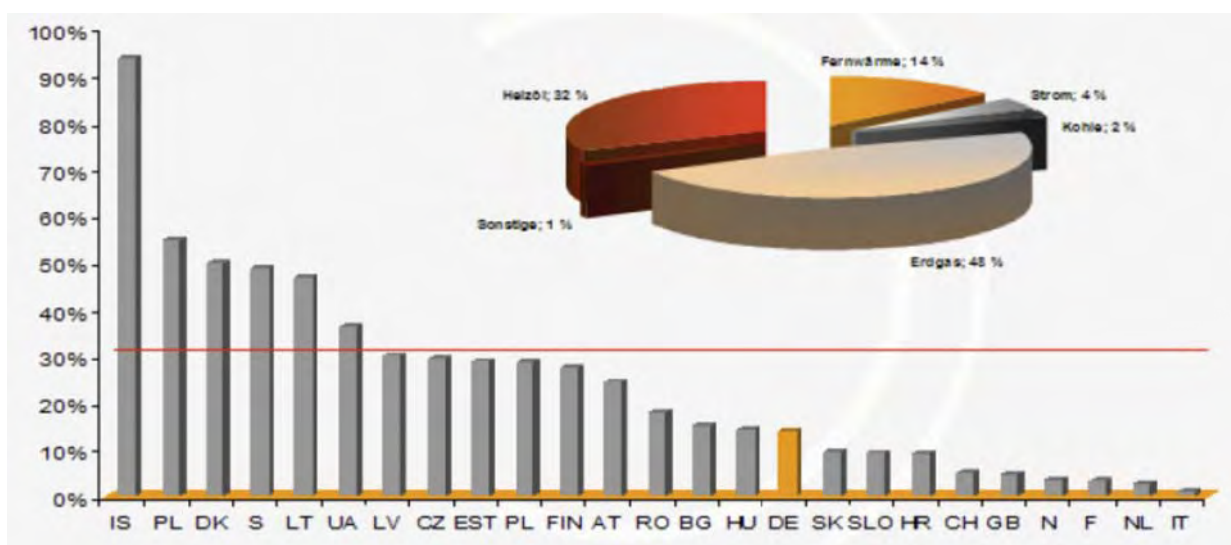

Figure 1 Relative amount of residential buildings heated by district heating in Europe by country (in 2010). The red line designates Germany's target value until 2020 [2].

2.2 Situation in Switzerland

In Switzerland, district heating is defined as heat supply in which case the main distribution network requires public ground and the heat is sold to third parties [7]. The statistically recorded district heating amounts to 18 000 TJ/a corresponding to 2% of the Swiss total final energy consumption of approximately 900 000 TJ/a (Figure 2). These indications are however based on an investigation amongst big DH plants and DH power plants which is conducted since 1978 and essentially includes waste incineration plants. Since smaller DH networks fuelled by wood, other renewable energies, heat pumps, fuel oil, or natural gas are not included, the actual importance of district heating is much higher as disclosed in the overall energy statistics.

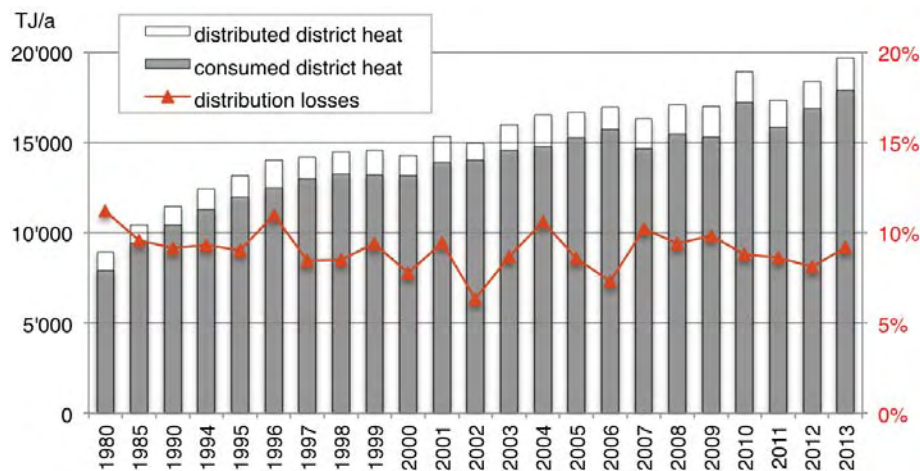

Figure 2 District heating in Switzerland in TJ/a and network losses from 1980 to 2013 according to data by [7].

The realisation of district heating networks was supported by the Swiss Confederation with approximately 36 million euro in the years 2009 to 2012 [8]. The criteria included that the heat generation included at least 80% renewable sources, that the networks had a minimum size of 1000 MWh/a, and that the linear heat density attained at least 1.3 MWh per year and meter of pipeline length at the construction start and 2.0 MWh/(a m) after completion according to QM Holzheizwerke [9]. 39 projects fulfilled the requirements and were supported thus triggering an investment volume of 243 million euro. 1 euro from the supporting program hence corresponded to 7 euro additional investment. The supported projects achieve heat outputs from renewable energy sources of approximately 282 GWh/a. This corresponds to roughly half a per cent of the Swiss heat market and yearly CO₂ savings of 75 000 tons compared to heating oil. In average, an energy output of 7 GWh/a was achieved per project corresponding, for instance, to an annual heat capacity demand of 3.5 MW at 2000 full-load hours.

The support is related to an average contribution of 127 euro for a heat distribution of 1 MWh per year. This corresponds to 0.64 euro cents per kWh in the case of a pessimistic calculation period of 20 years excluding interest rates. The majority of the supported projects, i.e. 30 plants, apply wood-fired heat generation, six projects use waste heat recovery from waste incineration plants, and three projects produce heat using heat pumps. The increased use of district heating hence triggers considerable investments and contributes highly to the use of energy wood.

3 Method

The assessment of the economic efficiency evaluates the specific cost of the heat distribution related to the heat delivered to the consumer. The heat distribution cost consists of capital and operation costs. The operation costs include the fuel cost covering the heat losses in the network, the electricity costs for the operation of the network as well as the service and maintenance costs. The system upon which the calculations are based is delimited by the system boundaries depicted in Figure 3. The specific heat distribution costs are determined by means of the equivalent annual cost (EAC) method as follows:

$$c = c_{\text{cap}} + c_{\text{op}}$$

c = Heat distribution cost in [c/kWh] with 1 kWh = 1 kWh to consumer delivered energy

c_{cap} = Capital cost in [c/kWh]

c_{op} = Operation cost in [c/kWh]

$$c_{\text{cap}} = \frac{I \cdot a}{\dot{Q} \cdot \tau} \cdot (100 \text{ c/€})$$

I = Investment cost of the distribution network in [€]

a = Annuity factor in [a^{-1}]; for $i = 0$: $a = \frac{1}{n}$ applies, for $i > 0$: $a = \frac{i(1+1)^n}{i(1+1)^n - 1}$ applies

with i = Imputed interest rate in [a^{-1}], n = Calculation duration in [a]

\dot{Q} = Connection load in [kW]

τ = Full-load hours of the heat consumer in [h/a]

$$c_{\text{op}} = c_{\text{F}} + c_{\text{E}} + c_{\text{M}}$$

$$c_{\text{F}} = f \cdot p_{\text{B}} / \eta_{\text{a}}$$

f = Fuel consumption to cover heat distribution losses in [kWh/kWh]

p_{F} = Fuel price based on heating value in [c/kWh]

η_{a} = Annual heat production efficiency in [%]

$$c_{\text{S}} = e \cdot p_{\text{S}}$$

e = Electricity consumption for pumping in [kWh/kWh]

p_{E} = Electricity price in [c/kWh]

c_{M} = Service and maintenance in [c/kWh]

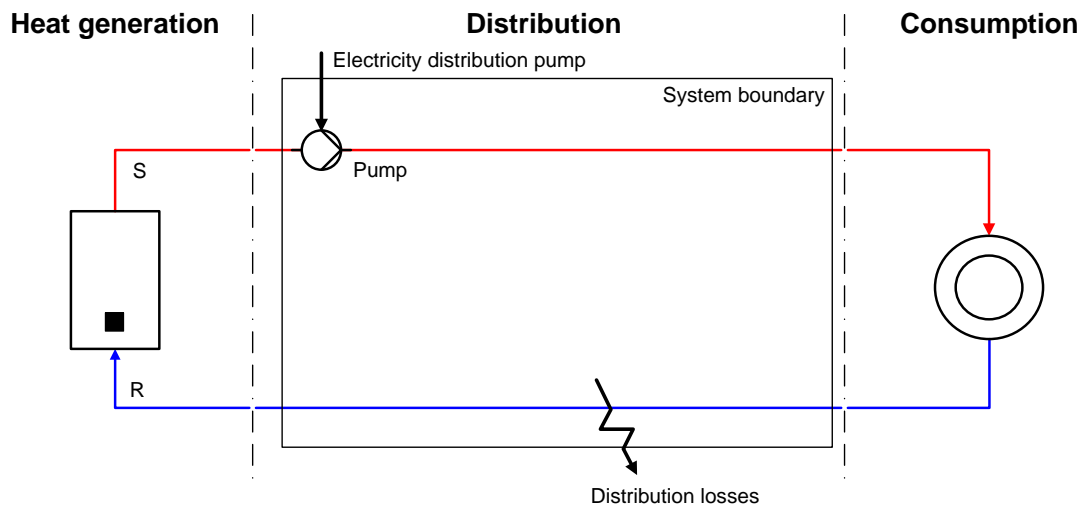

Figure 3 System boundaries for the calculation of a district heating network. S=supply, R=return

The investment costs comprise the cost of material and installation of the DH network including the excavation work for the trench of the pipes.

The operation costs are determined as follows:

- The heat loss costs depend on the heat distribution losses and the specific heat generation cost (“Production heat price”).
 - The heat distribution losses are determined by the heat transfer coefficient (U- value) of the district heating line, the pipeline length, the temperature difference between soil and district heating network, and the annual operation hours of the network. In order to calculate the U-value, underground pipes are assumed whose heat conductance is considered to include the insulation and the soil up to the surface. The insulation thickness is a parameter that will be varied.
 - The heat generator is assumed given. The specific heat generation costs to cover network losses are hence considered to consist only of costs induced by the additional fuel use. They are determined dividing the fuel price by the annual efficiency of the heat generation.
- The power consumption of the network pump is determined by the mass flow rate of the distribution water, the pressure difference in the network pump, the annual operation hours of the network, and the pump efficiency. The pressure drop is calculated for a typical wall roughness as a function of the flow velocity.
- The service and maintenance costs are neglected because they are considerably lower than the capital cost and the other operation cost.

4 Assumptions

4.1 Parameters for economic assessment

In order to analyse their influence, the losses and the costs of the heat distribution are determined for different system configurations and operation parameters. This is based on the reference case for a model DH network as described in the next chapter. The input values are summarised in Table 1 and the therefrom derived factors for the reference case and the various alternatives are summarised in Table 2. The reference value is defined as 1 kWh of heat delivered by the network. The calculations are conducted assuming the optimum network operation as designed. Since the pump efficiency decreases at part-load conditions, the electricity costs are overestimated. A “production heat price” of 5 euro cents per kWh of heat fed into the network corresponds to a fuel price of 4.15 c/kWh at a boiler efficiency of 83%. Table 3 summarises the assumptions used in the network calculations.

The investment cost for the pipelines depends on the pipe type, nominal diameter, and insulation size for the network as well as the pipe-laying costs. In the present report, reference values of the industry are used [10] which were confirmed by the experiences of existing DH networks [11]. The reference values for rigid plastic jacket pipes for underground installation in open space as depicted in Table 4 and visualised in Figure 4 serve as cost base. As shown in Figure 4, the excavation costs increase only slightly with increasing pipe diameter unlike the material costs which increase significantly. It furthermore appears that the total costs are dominated by the pipeline material cost. As displayed in Table 4, the pipe costs represent even at a nominal diameter of DN 80 61% and 75% of the total cost when laid in streets and open space, respectively. The share further increases with increasing diameters because the pipe costs significantly increase with increasing diameter. The considered reference case in open space corresponds to an optimistic case. Pipe-laying in roads results in roughly 20% and 15% higher total costs than presented in this study for DN 80 and DN 200, respectively. The present costs do not consider particularly complex construction work.

The cost for piping and civil engineering are valid for Switzerland and converted to euro using an exchange rate of 1 € = 1.21 CHF as valid per 2014. Even though the reference year of the data is 2012, inflation between 2012 and 2014 is virtually zero and the exchange rate is nearly constant (between 1.20 and 1.26 since 01/01/12). Prices for piping and civil engineering, however, can vary from country to country.

Table 1 Assumptions for cost calculation: input parameters.

Input parameters	Symbol	Unit	Reference				
Connection load	\dot{Q}	MW	-	0.5	1	2	-
Pipeline length	L	m	-	500	1000	2000	-
Full-load hours	τ	h/a	-	1000	2000	4000	-
Network operation hours	τ_N	h/a	-	2000	8760	4000	-
Network supply temp.	T_S	°C	40	60	80	100	-
Temperature difference	ΔT	K	-	15	30	45	60
Insulation Class	Series	-	-	1	2	3	-
Electricity price	p_e	c/kWh	-	8.25	16.5	33	-
Fuel price	p_F	c/kWh	0	2.5	4	10	-
Calculation duration	n	a	-	-	30	-	-
Capital interest rate	i	% / a	-	0	3.0	6.0	-

Table 2 Assumptions for cost calculation: Derived factors. *Annual heat production efficiency 83%.

Derived factors	Symbol	Unit	Reference				
Linear heat density	-	MWh/(a m)	-	-	2.0	-	-
Average network temp.	T_m	°C	-	-	65	-	-
Annuity factor	a	% / a	-	3.33	5.10	7.26	-
Heat production price*	p_B	c/kWh	0	2.5	5	10	-
$\frac{\text{Electricity price}}{\text{Fuel price}}$	$\frac{p_e}{p_B}$	-	-	-	3.3	-	-

Table 3 Calculation parameters of the model district heating network. *Depends on the pipeline system, nominal diameter, and insulation class (Series 1, Series 2, Series 3). The cost for Series 2 is displayed in Table 4.

Parameter	Symbol	Value	Unit
Heat conductivity insulation material - pipe	λ_D	0.026	W/(m K)
Insulation size - pipe	d_D	30-110*	mm
Ground temperature (Annual average)	T_B	10	°C
Heat conductivity - soil	λ_B	1.2	W/(m K)
Cover depth of pipes	$h_{\ddot{u}}$	0.6	m
Roughness of pipe walls	k	0.01	mm
Heat capacity of water at 60°C	c_{pW}	4184	J/(kg K)
Density of water at 60°C	ρ_W	983	kg/m ³
Kinematic viscosity of water at 60°C	ν_W	$4.873 \cdot 10^{-7}$	m ² /s
Minimum flow velocity in the pipeline	u_{min}	0.35	m/s
Pump efficiency	η_P	80%	%
Electric pump drive efficiency	η_M	90%	%
Pump and motor efficiency	η_{PM}	72%	%
Specific investment cost of pipeline per meter	k_R	650–1250*	€/m

Table 4 Specific investment cost for rigid plastic jacket pipes for underground installation with insulation class Series 2 divided into piping and construction cost [10]. For the trench, costs for open field or street application are distinguished resulting in respective total cost. The piping costs include all costs of material and installation such as pipes, bends, tees, sockets, strain zones, pipe supports, weld material, monitoring system and pressure test. The trench costs include the trench work (excavation, sand bedding, backfilling, and restoring the earth's surface). Not included are the X-ray of welds, the relocation of utility lines and any traffic regulations.

Nominal Diameter	Piping cost	Trench cost		Total cost		Cost share piping	
		open field	street	open field (Reference)	street	open field	street
DN	€/m	€/m	€/m	€/m	€/m	%	%
20	226	83	165	308	391	73	58
25	231	83	165	313	396	74	58
32	257	83	165	340	422	76	61
40	272	83	165	355	437	77	62
50	293	107	202	400	495	73	59
65	335	107	202	442	537	76	62
80	376	124	240	500	616	75	61
100	504	140	256	645	760	78	66
125	640	157	273	798	913	80	70
150	791	165	310	956	1101	83	72
200	960	182	351	1141	1311	84	73
250	1363	207	393	1569	1755	87	78

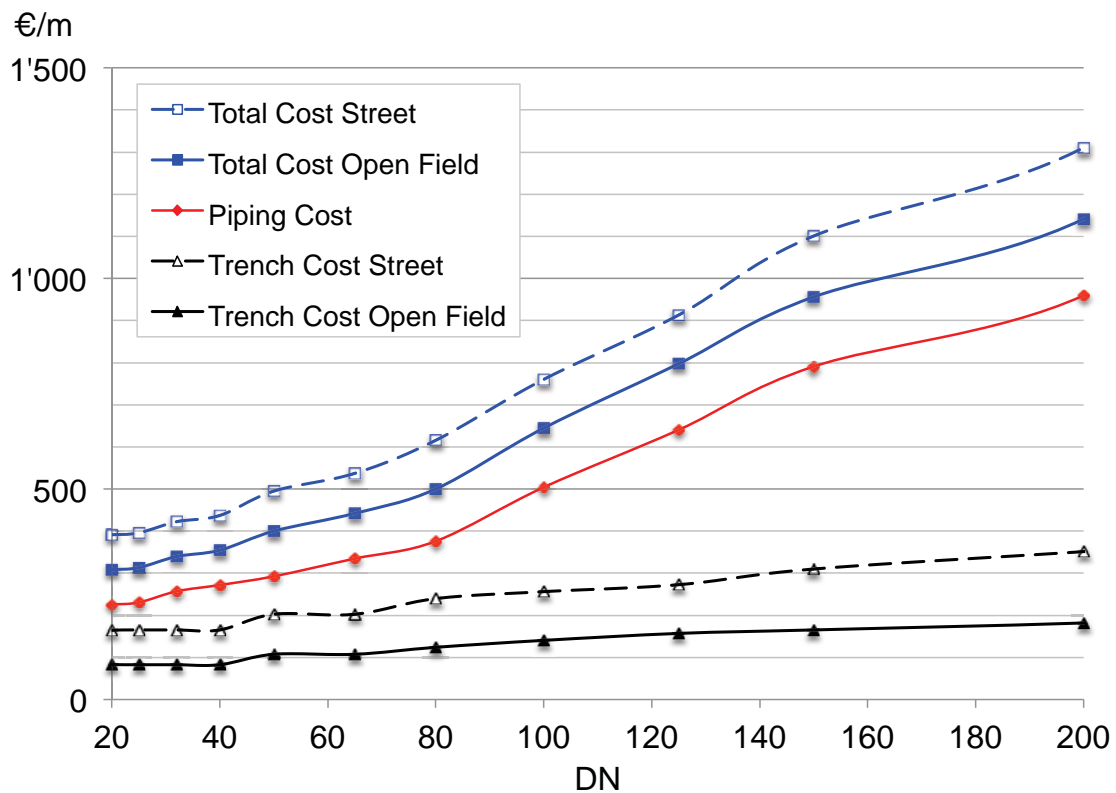

Figure 4 Specific investment cost for rigid plastic jacket pipes for underground installation divided into piping and construction cost for the trench as given in Table 4 [10].

4.2 Piping design

The calculations are done for the nominal diameters DN 20, 25, 32, 40, 50, 65, 80, 80, 125, 150, and 200. The considered diameters correspond to the actual inner diameters of rigid plastic jacket pipes but can substantially differ from the numerical values of the DN labels (Table 5). It is also important to note that the steps between the cross-sectional areas of one DN to the next amount to 49% in average but exhibit in reality a range of 21% to 74%.

Since the calculations cover a wide span, the ranges with appropriate flow velocities are considered in the graphs. Within these ranges, the velocities are limited by the maximum values recommended by the ÖKL Merkblatt-Nr. 67 (Table 5, [12]) in order to prevent unacceptable noise emissions in the district heating pipelines. In the graphs, the lower bound is delimited by an indicative value of 0.35 m/s. Thereby, only three to four nominal diameters are considered and very low flow velocities are excluded.

Table 5 Nominal diameters DN with actual inner diameters for rigid plastic jacket pipes as well as the area ratio of each DN to the next smaller DN, and data on maximum flow velocities by [12].
*from DN 50 equal to connecting pipe.

Nominal diameter DN	Rigid plastic jacket pipe		Maximum flow velocity	
	Inner diameter [mm]	Area ratio A_{n+1} / A_n [-]	Connecting pipe [m/s]	Supply lines* [m/s]
20	21.6	-	0.6	0.5
25	28.5	1.74	1.0	0.6
32	37.2	1.70	1.1	0.8
40	43.1	1.34	1.2	1.0
50	54.5	1.60	1.4	
65	70.3	1.66	1.6	
80	82.5	1.38	1.8	
100	107.1	1.69	1.9	
125	132.5	1.53	2.0	
150	160.3	1.46	2.5	
200	210.1	1.72	3.3	
250	263.0	1.57	3.9	
300	312.7	1.41	4.3	
350	344.4	1.21	4.6	
400	393.8	1.31	5.0	
450	444.6	1.27		
500	495.4	1.24		
Average		1.49		
Maximum		1.74		
Minimum		1.21		

Instead of specifying maximum flow velocities, recommended values for the specific pressure drops are additionally indicated in Figure 5 QM Holzheizwerke recommends a design of 150 to 200 Pa/m [9]. Based on practical experience, values of 200 Pa/m are also recommended including exhaust limits of up to 250 Pa/m to cover peak loads during maximally 500 operating hours [13]. In Figure 5 are displayed various recommendations for flow velocities as function of the inner diameter for constant specific pressure drops of 100 Pa/m, 200 Pa/m, and 300 Pa/m. They were determined using the approximation formula for the friction factor in the transition section [14] assuming pipe friction factors of 0.020 for DN 20, 0.016 for DN 80 and 0.015 for DN 400. The comparison reveals the recommendations by ÖKL to result in a similar design compared to the calculations with maximum pressure drop of slightly less than 300 Pa/m (Figure 5).

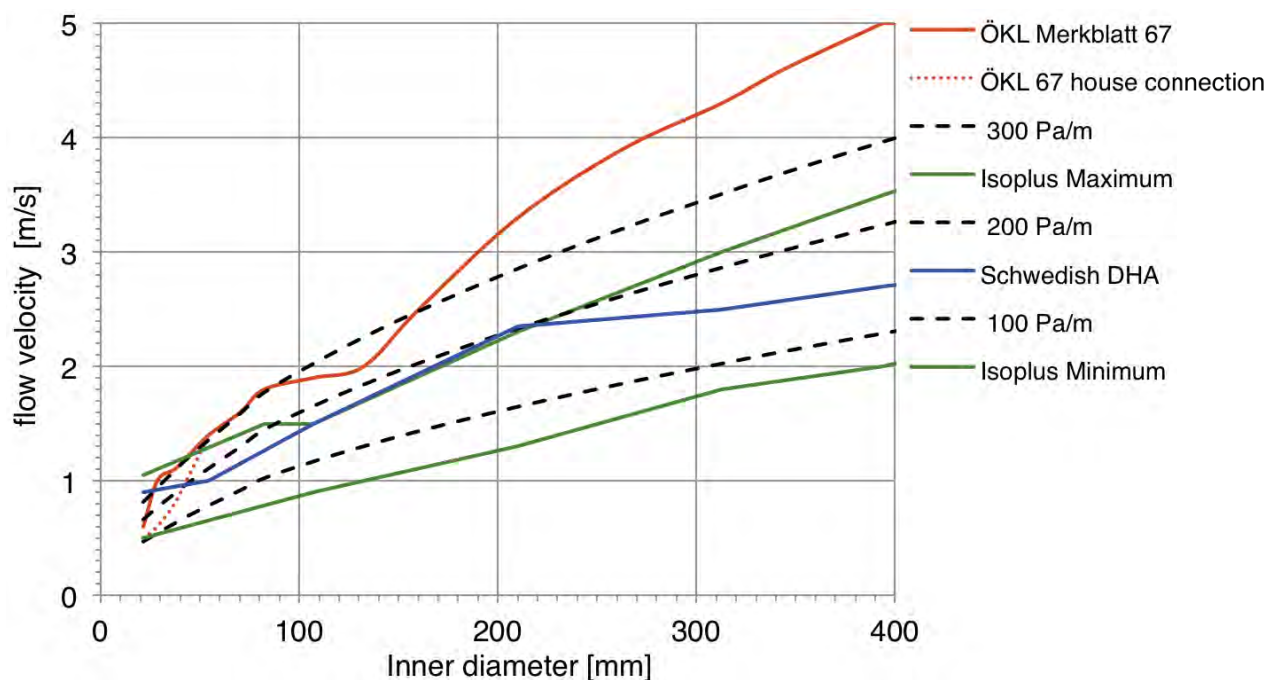

Figure 5 Flow velocities as function of the inner diameter:

- For pressure drops of 100 Pa/m, 200 Pa/m, and 300 Pa/m (calculated, simplified).
- Recommendations for maximum flow velocities by ÖKL [12].
- Recommendations by Isoplus (max and min) [1].
- Recommendations by the Swedish District Heating Association (DHA) [1].

4.3 Model district heating system

A DH network consists of one or several heat generation stations, the heat distribution network, and the heat consumer. According to its size and complexity, a DH network has one or several heat stations, different network structures (radial, loop, mesh network, etc.) and more or less heat costumers (Figure 6). The structure is determined by urbanistic factors (configuration of buildings and roads), the network size, and the integration of heat generators, amongst others [15].

In order to describe the influence of each parameter on efficiency and profitability of DH networks, a reduced model DH network with one heat station, one pipeline, and one heat consumer is examined (Figure 7). Even though the influence of the network structure is not included, the model enables an isolated evaluation of the influence of single parameters. Since the heat consumption is modelled to incur at maximum distance to the heat source, the model exhibits larger investment costs and heat losses for a given linear heat density than a real network where the costumers are distributed along the whole length of the pipeline.

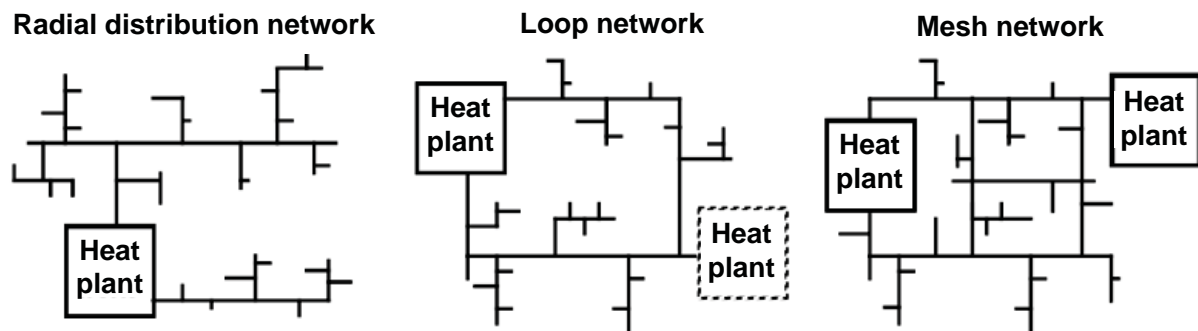

Figure 6 Overview of the different network structures [15].

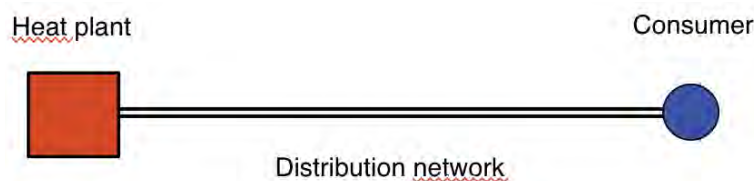

Figure 7 Schematic representation of the model district heating network.

5 Results

5.1 Heat distribution losses

In Figure 8 to Figure 11 are displayed the heat distribution losses of the model district heating network as function of the nominal diameter. The operating parameters always correspond to the reference case in Table 1 with the exception of one shear parameter. The bold line (blue) designates a design based upon reference values. The light red areas denote the nominal diameters with admissible flow velocities. The markers correspond to the calculated nominal diameters as in Table 4. The lines represent the polynomial trendline and enhance the readability of the diagrams however do not correspond to calculated values. The discontinuity of the lines can be attributed to the non-compliance of the nominal diameters with the geometric diameters used in the calculations.

5.1.1 Influence of the insulation class (Figure 8)

The reference case with insulation class Series 2 and minimum diameter results in heat distribution losses of roughly 10.5%. The target value of 10.0% is only achieved with the maximum insulation class Series 3 and only if the minimum or one nominal diameter larger than the minimum diameter is chosen. In contrast, a network with insulation class Series 3 but third smallest diameter already results in slightly higher losses than a network with minimum diameter and insulation class Series 2. It however exhibits much higher investment costs as stated in chapter 5.2. Using the insulation class Series 2 (reference value) instead of Series 3 (maximum insulation) increases the losses by roughly 15%, for insulation class Series 1 (minimum insulation) by 40%.

5.1.2 Influence of the temperature difference (Figure 9)

A decrease in the temperature difference from 30 K to 15 K results in a theoretical increase of the losses from 10.5% to 13.0% in the reference case with the smallest diameter. In order to operate the network at halved temperature difference, it is however necessary to increase the nominal diameter by one step resulting not only in higher investment cost but also in an additional increase of the losses to 13.5%. The losses contrarily decrease with increasing temperature difference and enable the use of smaller diameters.

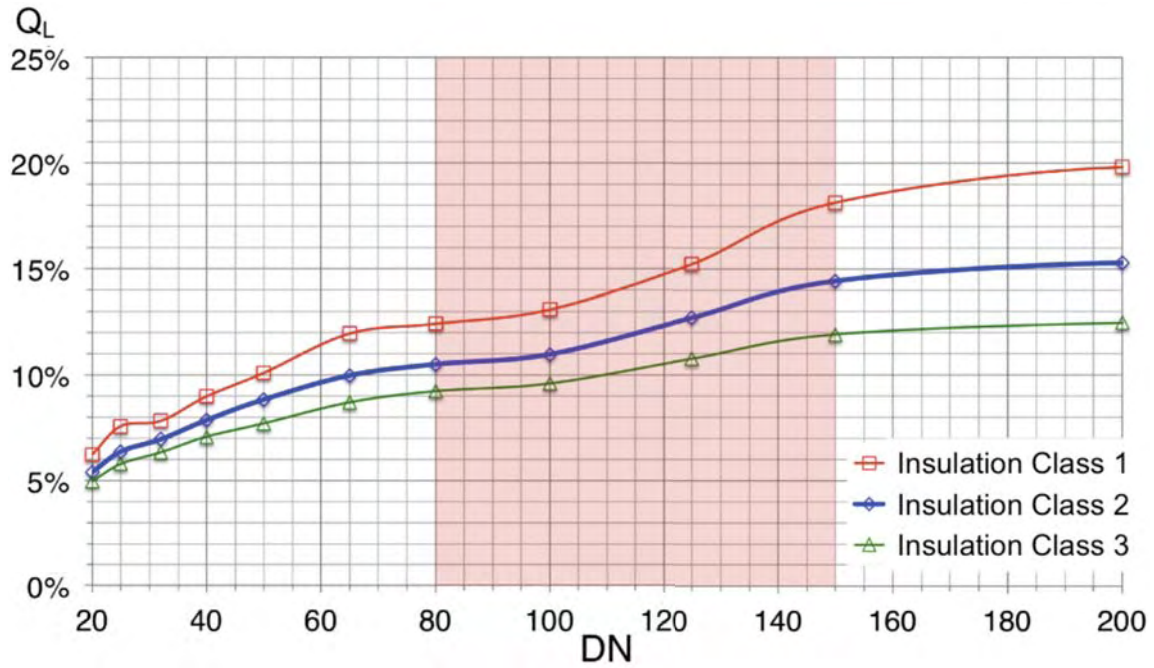

Figure 8 Heat distribution losses as function of the nominal diameter for different insulation classes. Reference case: Insulation class Series 2. Red area: nominal diameter with admissible flow velocity.

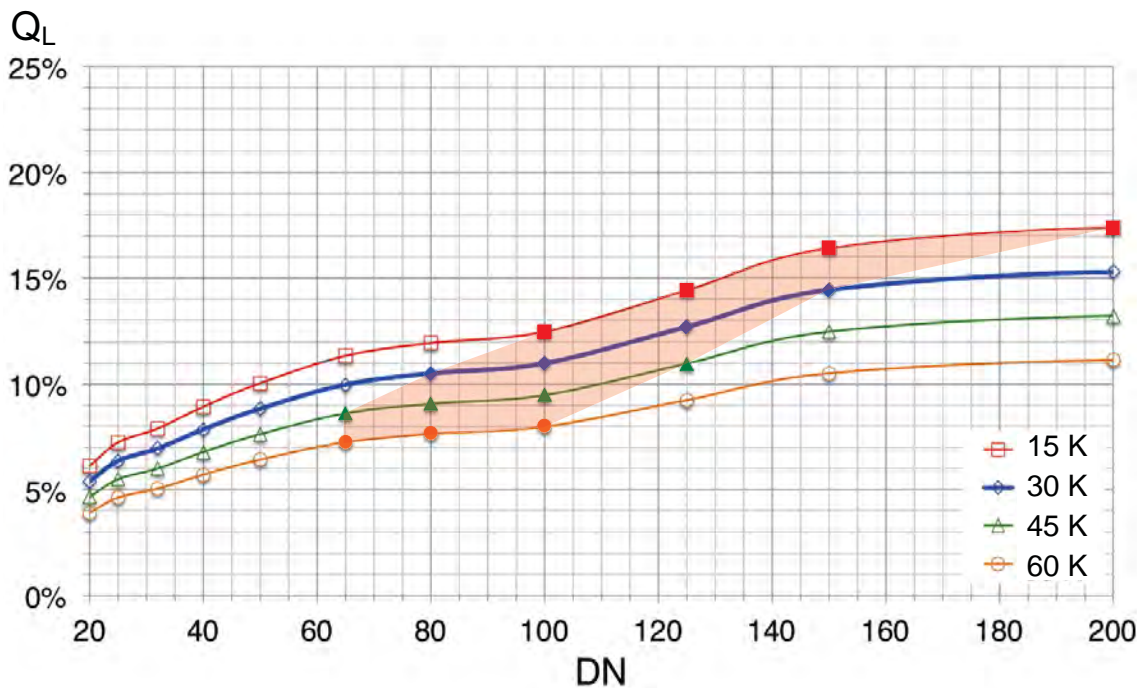

Figure 9 Heat distribution losses as function of the nominal diameter for various temperature differences. Reference case: $\Delta T = 30$ K. Red area: nominal diameter with admissible flow velocity.

5.1.3 Influence of the full-load hours and as a consequence the linear heat density (Figure 10)

In the reference case, an annual operation of 8760 h/a is assumed. Doubling the full-load hours of heat generation from 2000 h/a to 4000 h/a (implying a correspondent amount of heat customers with base load) cuts the specific heat distribution losses in half since the absolute losses are constant while the heat supply is doubled. Halving the full-load hours correspondingly results in doubling the specific losses. A reduction of heat demand of present customers due to energetic renovations consequently results in increasing specific losses in the DH network.

Varying the full-load hours of the heat generator at constant pipeline length and connection load shifts the linear heat density in a directly proportional way. The influence of the full-load hours as displayed in Figure 10 may therefore also be described by the linear heat density. For this reason, the according specifications are given in Figure 10.

For seasonally operated networks, the described influences also apply but are less distinct due to fewer operating hours.

5.1.4 Influence of the connection load and as a consequence of the linear heat density (Figure 11)

Doubling the connection load of the given network from 1 MW to 2 MW yields in the doubling of the linear heat density from 2 to 4 MWh per year and meter of pipeline length. In order to distribute the increased heat load, an increase in pipe diameter by one nominal size is necessary. The heat distribution losses would however be halved at the same diameter. Due to the shift to a larger diameter, the actual losses amount to slightly more than half.

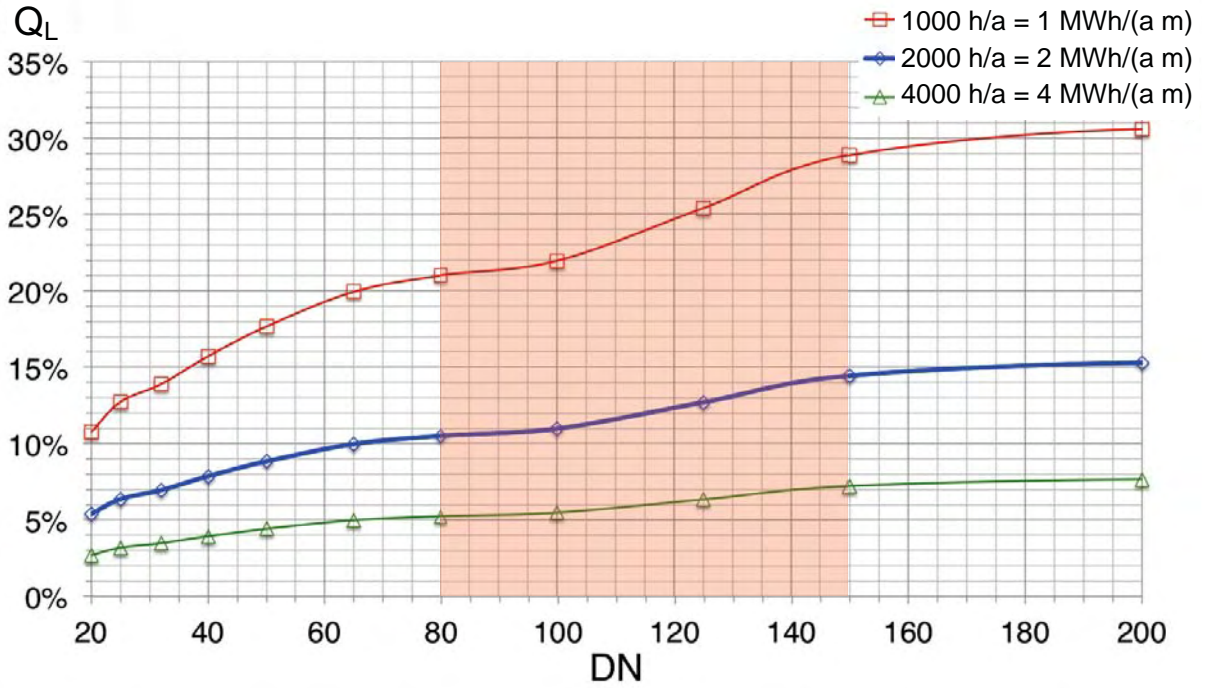

Figure 10 Heat distribution losses as a function of the nominal diameter for different full-load hours and the resulting line heat densities. Reference case: 2000 h/a (2 MWh/(a m)).

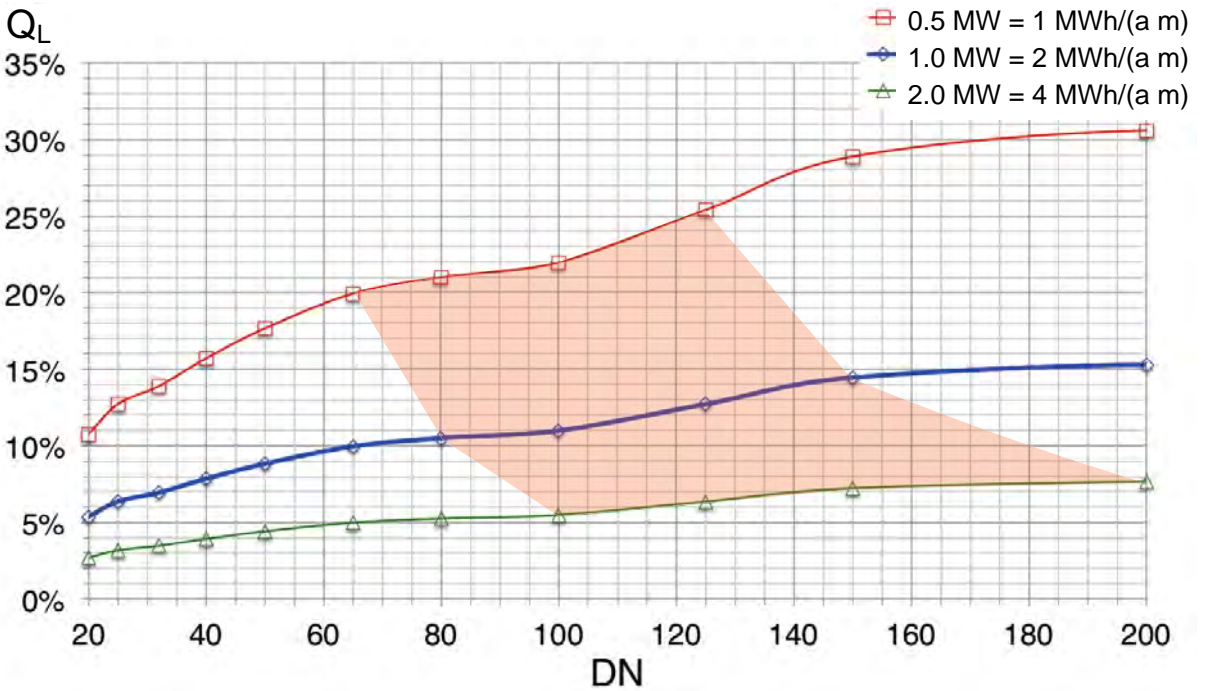

Figure 11 Heat distribution losses as a function of the nominal diameter for different connection loads and the resulting line heat densities. Reference case: 1 MW (2 MWh/(a m)).

5.2 Economic analysis

In the graphs describing the economics, the admissible nominal diameters are designated with filled markers. Besides, the same specifications apply as for the heat distribution losses in chapter 5.1.

5.2.1 Share of the capital and operation cost (Figure 12)

The electricity cost decreases with increasing pipe diameter thanks to a decreasing pressure drop, whereas the capital cost and the costs to cover the heat losses increase as a consequence of the increasing investments and heat losses, respectively. The heat distribution cost curve therefore exhibits a minimum at optimum pipe diameter. In the reference case, the minimum appears at 2.16 c/kWh and a nominal diameter DN 80 (Figure 12). This economically ideal diameter corresponds to the smallest technically feasible one since smaller nominal diameters exhibit inadmissible flow velocities.

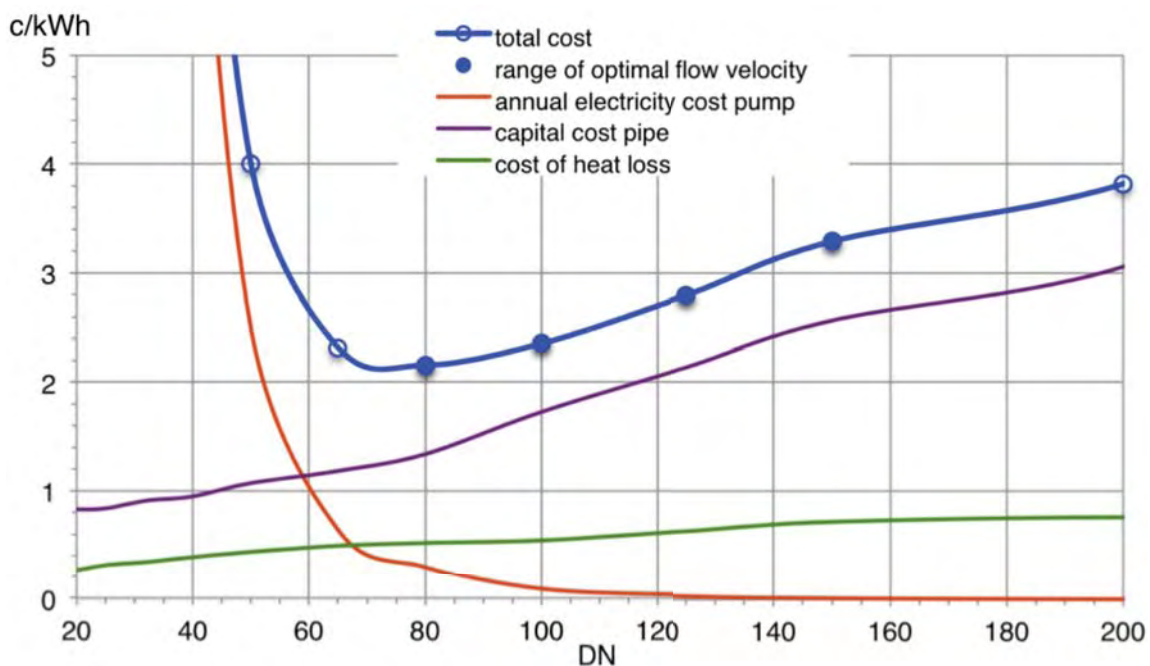

Figure 12 Heat distribution losses indicated as total cost and divided in capital cost, heat loss costs, and electricity costs as function of the nominal diameter for the reference case. The four allowed nominal diameters are designated with filled markers.

Different boundary conditions, such as lower electricity prices and/or higher annuity, imply situations where the economically optimal diameter has inadmissible flow velocities. In this case, the smallest admissible nominal diameter needs to be chosen. Contrarily, situations may appear where the economically optimal diameter is larger than the smallest technically feasible diameter, i.e. at very high electricity prices or very favourable interest rates. The following sensitivity analysis however shows that both cases do not or only partially appear in the studied model network even when the examined parameters deviate from the initial values by a factor of two.

The heat distribution cost of 2.16 c/kWh mainly comprises of capital cost with 1.24 c/kWh or a share of 62%. The fuel cost to cover the heat losses contributes 0.52 c/kWh or 24% to the cost. The pumping power accounts for the smallest share of the total cost with 0.30 c/kWh or 14%. In comparison with the minimum nominal diameter, a network with a increased nominal diameter by one nominal size, i.e. DN 100 instead of DN 80, results in a 9% increase of the heat distribution cost. A two-sizes larger nominal diameter (DN 125) causes an increase in heat distribution cost by 30%.

5.2.2 Influence of the interest rate (Figure 13)

Since the capital costs represent the main share, the interest rate has a considerable influence on the total cost. Doubling the interest rate from 3 % p.a. to 6% p.a. for a calculation period of 30 years thus results in an increase of the heat distribution cost by 20%, whereas interest-free capital decreases the cost by 20%. The reduction of the calculation period to 20 years, for instance, influences the results comparably less.

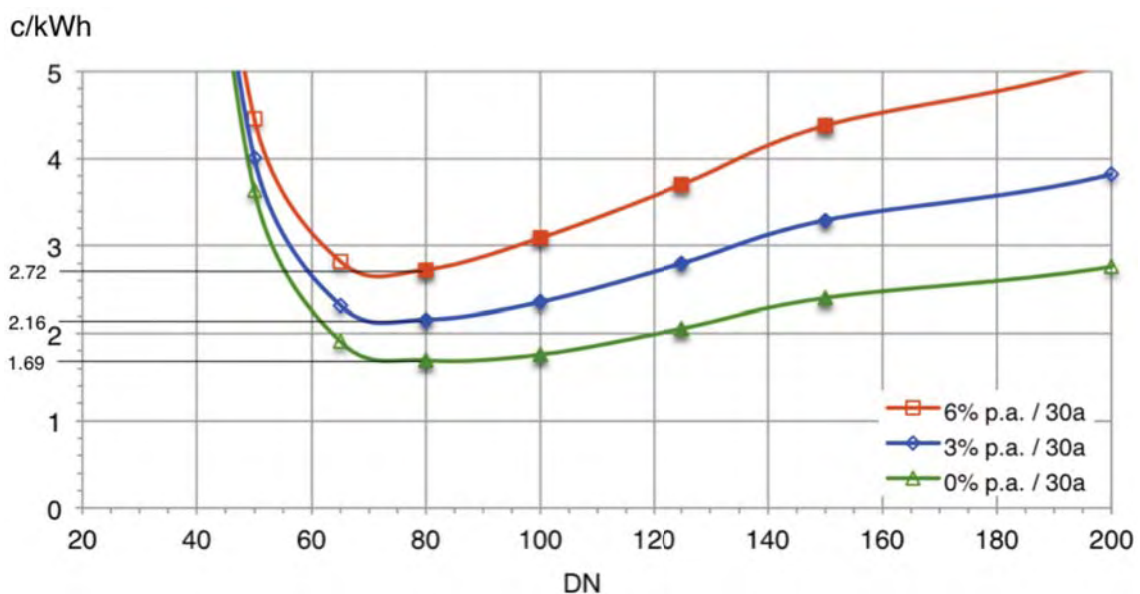

Figure 13 Heat distribution cost as function of the nominal diameter for different interest rates.
Reference case: 3% p.a. for 30 years.

5.2.3 Influence of the fuel price (Figure 14)

Based on a “production heat price” of 5 c/kWh which corresponds to a fuel price of 4.15 c/kWh, halving the fuel price results in a decrease of the total cost by 13%. In the case of cost-free fuel, the reduction amounts to 26%. Doubling the fuel cost results in an increase of total cost by 26%.

5.2.4 Influence of the insulation thickness (Figure 14)

Figure 14 additionally illustrates the influence of the insulation thickness (DS). Respecting the economic boundary conditions in the reference case, the improved pipe insulation leads to slightly increased heat distribution cost since the higher capital cost are not compensated by the fuel savings. The heat losses can however be significantly lowered thanks to improved insulation (Figure 8), whereas the heat distribution costs only slightly increase (Figure 14). It is therefore recommended to nevertheless use the thickest insulation. Choosing the smallest possible nominal diameter exhibits a much higher influence on the total cost than the insulation thickness (Figure 14, more details in [3]):

Based on insulation class Series 2, Series 3 is roughly 2% more expensive for DN 80 and Series 1 roughly 1% cheaper.

Series 3 exhibits practically identical cost in combination with DN 80 than Series 1 with DN 100.

For comparison, a pipe which has a two sizes larger nominal diameter than necessary (DN 150 instead of DN 100) causes approximately 41% higher total cost at equal insulation class.

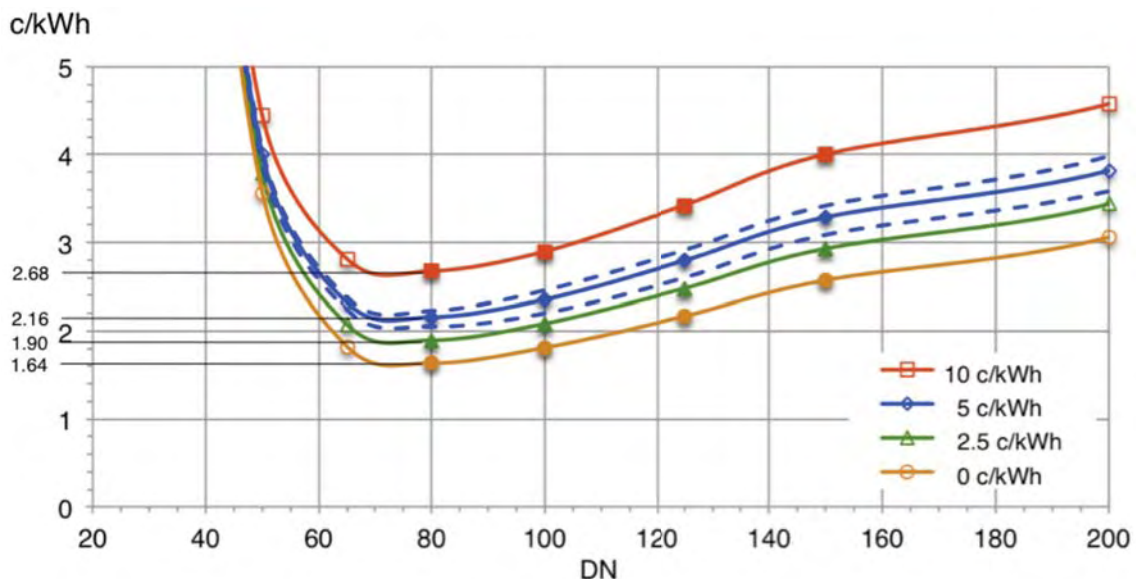

Figure 14 Heat distribution cost as function of the nominal diameter for different heat prices at the production side. Reference case: Heat price 5 c/kWh in accordance with a fuel price of 4.15 c/kWh and an annual capacity factor of 83%. Additionally, the variation of the insulation class is indicated for the reference case (blue). Upper dashed line Series 3 (max), continuous line Series 2 (reference) and lower dashed line Series 1 (min).

5.2.5 Influence of the electricity price (Figure 15)

Since the pump output significantly increases at small nominal diameters only, the electricity price considerably influences the total cost only in the case of a network designed with the smallest possible nominal diameter. Based on an electricity price of 16.5 c/kWh, the cost increase by 13% upon doubling of the electricity price and decrease by 7% upon halving. In the case of a next larger nominal diameter, the differences are already significantly lower with plus 4% and minus 2%, respectively.

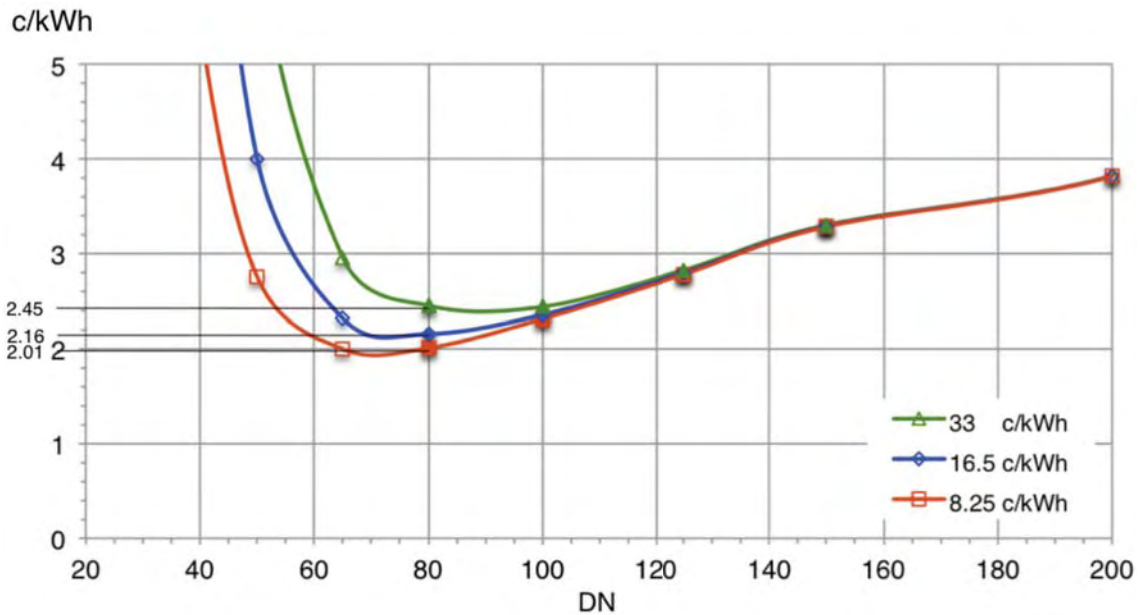

Figure 15 Heat distribution cost as function of the nominal diameter for different electricity prices. Reference case: 16.5 c/kWh

5.2.6 Influence of the supply temperature (Figure 16)

An increase in supply temperature by 20°C results in higher heat losses and hence in heat distribution costs increased by 9%. Contrarily, the costs fall by 9% upon reduction of the supply temperature by 20°C. If the smallest admissible nominal diameter changes due to shifted supply temperature, which is however not the case in this study, the influence of the supply temperature may be more significant.

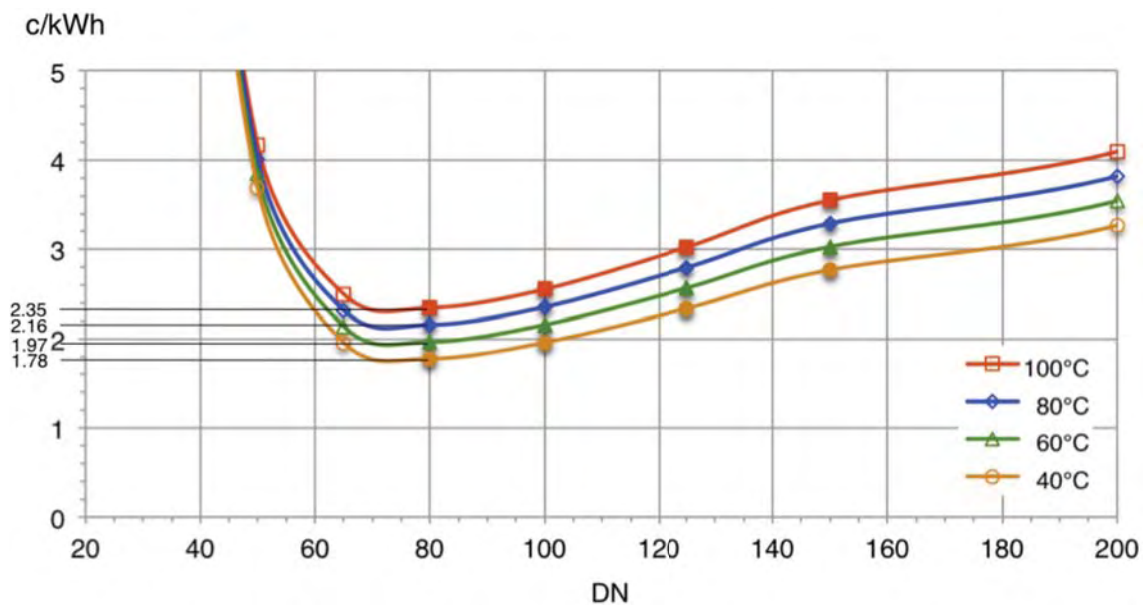

Figure 16 Heat distribution cost as function of the nominal diameter for different supply temperatures. Reference case: 80°C.

5.2.7 Influence of the temperature difference (Figure 17)

Upon doubling of the temperature difference, the nominal diameter may be reduced by one size, in some cases even by two (Figure 17). In combination with the lower network temperature, the temperature difference highly influences the heat distribution costs. At the corresponding optimum nominal diameters, they are thus reduced from 2.16 to 1.82 c/kWh or 15% upon increase of the temperature difference from 30 K to 45 K. A temperature difference of 15 K instead of 30 K contrarily induced an increase in cost from 2.16 to 2.94 c/kWh or 36%.

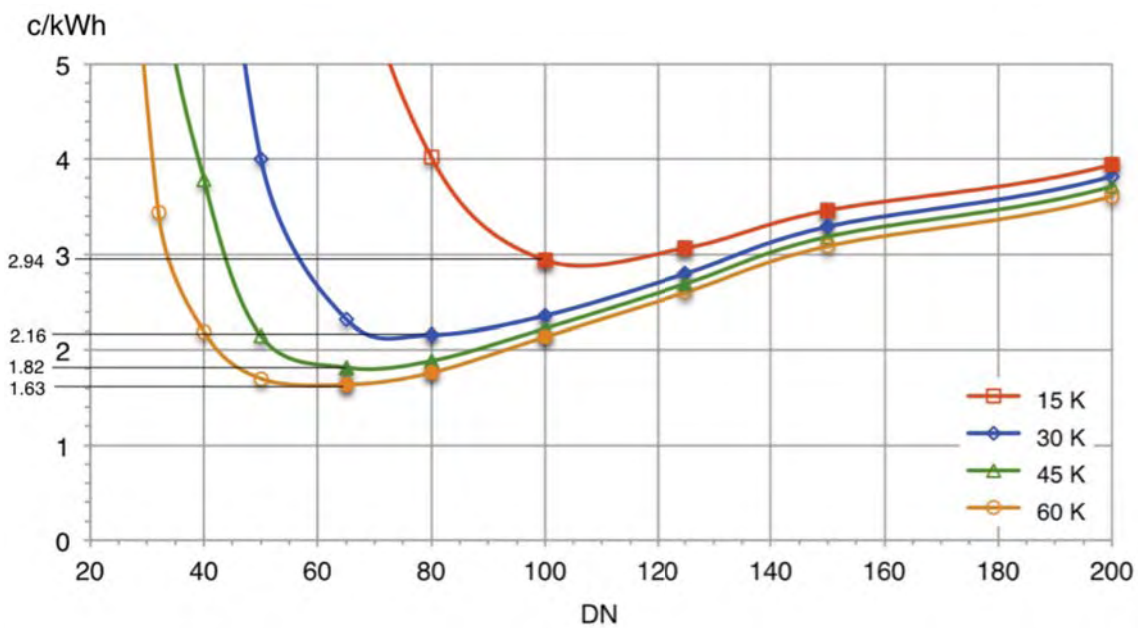

Figure 17 Heat distribution cost as function of the nominal diameter for different temperature differences. Reference case: 30 K.

5.2.8 Influence of the full-load hours and consequently the linear heat density (Figure 18)

In the case of a year-round operated network, the doubling of the full-load hours of the heat generation results in the halving of the specific heat distribution cost because the heat supply is doubled at equal expenditures. The specific costs are hence inversely proportional to the full-load hours of the heat generation.

The linear heat density for its part is proportional to the full-load hours. The heat distribution cost are hence also inversely proportional to the linear heat density as depicted in Figure 18 for the model district heating network with a connection load of 1 MW and a pipeline length of 1000 m.

5.2.9 Influence of the network length respectively the connection load (Figure 19 and Figure 20)

Figure 19 shows the heat distribution costs for a network with a doubled pipeline length and linear heat density compared to the reference case. The connection load still amounts to 2 MWh/(a m) at a number of full-load hours of 2000 h/a. Upon doubling of the connection load, the diameter of the example pipe needs to be increased by one nominal size, i.e. DN 100 instead of DN 80. The comparison with the reference case as in Figure 18 reveals that a district heating network with a length of 2000 m yields an increase in heat distribution costs by 32% as compared to a network with a length of 1000 m if in both cases the smallest possible diameter is chosen (2.86 c/kWh instead of 2.16 c/kWh).

For these two cases, the influence of the connection load is further illustrated in Table 6. As shown by the individual contributions of the cost factors, the most important increase results from higher capital cost, followed by a significant increase of the pumping cost, while the fuel costs to cover the additional heat losses are of minor importance.

Table 6 Influence of the connection load on heat losses and heat distribution costs: Comparison of specific parameters at the optimum pipe diameter for district heating systems with an identical linear heat density of 2 MWh/(a m).

Parameter	Unit	1 MW 1000 m	2 MW 2000 m	Increase	Relative Increase	
Optimum nominal pipe diameter	–	DN 80	DN 100	–	–	
Annual Heat Losses	%	10.5	11.0	+ 0.5 %	+ 4 %	
Heat distribution cost	Electricity	c/kWh	0.30	0.59	+ 0.29	+ 97 %
	Capital cost	c/kWh	1.34	1.73	+ 0.39	+ 29 %
	Heat losses	c/kWh	0.52	0.54	+ 0.02	+ 4 %
Total	c/kWh	2.16	2.86	+ 0.70	+ 32 %	

Figure 20 shows the case of a network with halved pipeline length and connection load. The inverse effects thereby appear as compared to doubling the pipeline length and hence decrease the heat distribution cost by roughly 18% compared to the reference case (1.77 c/kWh instead of 2.16 c/kWh).

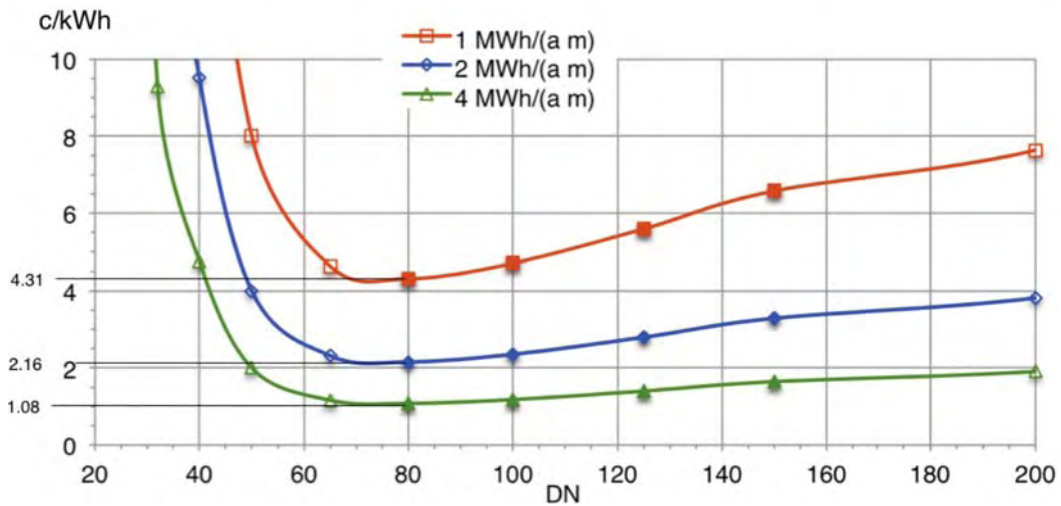

Figure 18 Heat distribution cost as function of the nominal diameter for different full-load hours and accordingly different line heat densities at a connection load of 1 MW and a pipeline length of **1000 m**. Reference case: 2000 h/a respectively 2 MWh/(a m).

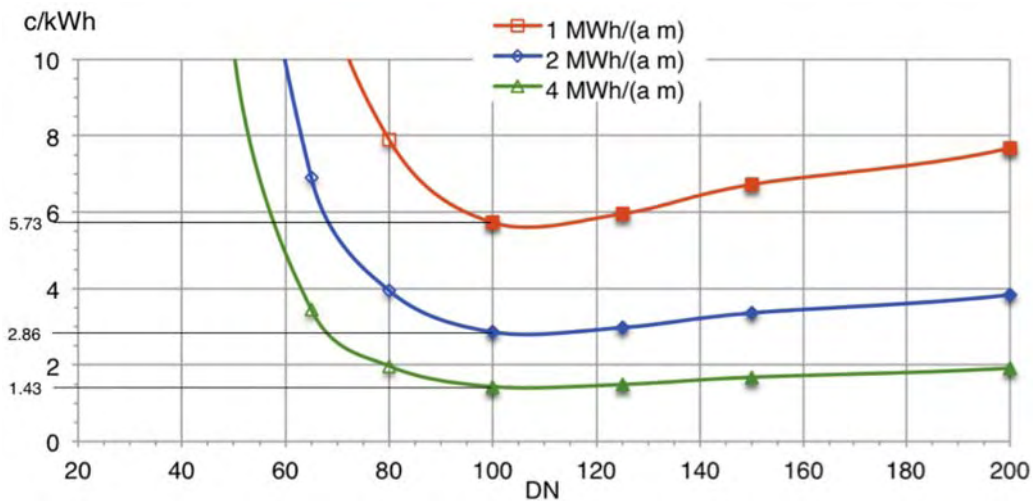

Figure 19 Heat distribution cost as function of the nominal diameter for different full-load hours of the heat generation and accordingly different line heat densities at a connection load of 2 MW and a pipeline length of **2000 m**. Reference case: 2000 h/a respectively 2 MWh/(a m).

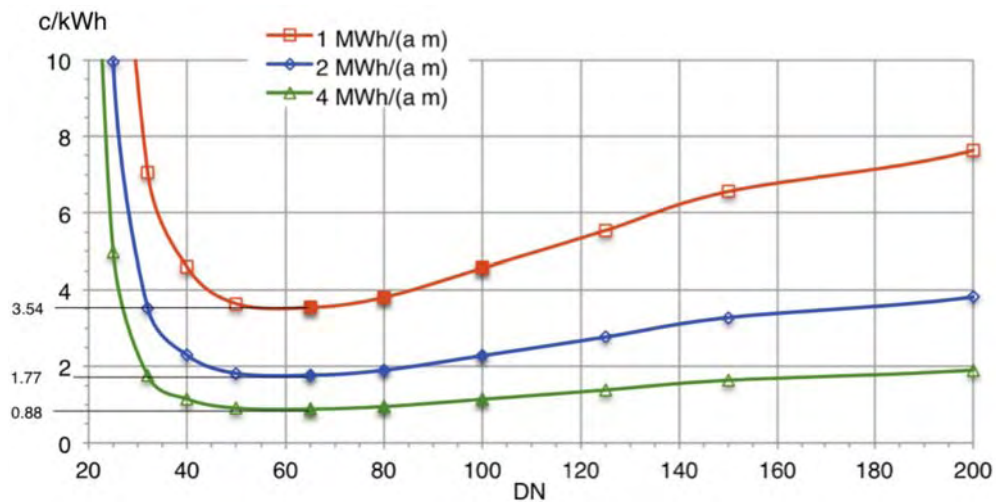

Figure 20 Heat distribution cost as function of the nominal diameter for different full-load hours of heat generation and accordingly different line heat densities at a connection load of 0.5 MW and a pipeline length of **500 m**. Reference case: 2000 h/a respectively 2 MWh/(a m).

5.2.10 Diseconomy of scale and influence of layout (Figure 21, Figure 22)

The comparison of the above described three cases in Figure 18, Figure 19, and Figure 20 reveals, that the heat distribution cost are related to a strong diseconomy of scale for a linear expansion of the network at constant linear heat density. This case is assumed as “worst case” for the expansion of a district heating system described by a linear connection in Figure 21. In addition, a constant heat distribution is assumed for the whole pipe length, which also corresponds to a worst case scenario as it occurs e.g. for the connection of one single consumer (or a group of consumers) at a long distance from the heat supplier. Instead of a linear expansion of one single pipe, more favourable layouts are often possible and implemented if applicable. To evaluate the influence of the connection load for other network expansions, a comparison between different cases is introduced in Figure 21 as follows:

- **Radial connection:** When starting from one simplified part of a district heating system, defined as a “module” of 0.5 MW, 500 m, and 2000 h/a (equaling 2 MWh/(a m)), a favourable expansion of the network is a radial connection by adding a second identical module to the opposite direction from the heat production site. This case is considered as ideal, since the specific heat distribution cost remain constant at increasing connection load as described in Table 7 and illustrated in Figure 22. For a radial expansion, also four pipelines to different directions are possible if the heat production plant is located in the centre of a populated area. For this case, the heat distribution cost remain constant also for a further expansion of the network, in the given example from 0.5 MW to 2 MW at 1.77 c/kWh.
- **Linear connection:** By increasing the number of main pipes, the radial connection once achieves a sufficiently fine distribution to supply the surrounding consumers with short distance connections from the main pipe. Hence from a certain number of radial connections, a further expansion of the network can only be achieved by a linear expansion of the main pipes enabling the supply of more distant consumers. From this point, the expansion of each individual pipe follows the expansion type of a linear connection.

Linear connection with 1 consumer (worst case):

Assuming that all heat is distributed over the whole pipe length to one single consumer corresponds to the “worst case” in Figure 21 and to the pre-described examples in Figure 18 to Figure 20. This linear expansion of the network is related to a strong diseconomy of scale, mainly due to the significant increase of the specific capital cost (which is due to the larger pipe needed for the heat distribution at constant linear heat density), and in addition due to the increased specific electricity cost (which is due to the longer transport of the hot water) as shown in Table 7 and in Figure 22.

Linear connection with distributed consumers:

More favourable and often applicable is the situation of distributed consumers over the pipe length. Due to a stepwise reduction of the transported heat and pipe diameter, the capital cost, the electricity consumption, and the heat losses are slightly reduced compared to the worst case with one single consumer, thus leading to reduced heat distribution cost as illustrated in Table 7 and in Figure 22.

- **Radial and linear connection:** If a reasonable number of radial connections is achieved, a further expansion can be ascertained by linear connection of each pipe. This is described by the example “radial + linear” consisting of four radial pipes, each being doubled from the initial pipe length one module and exhibiting one consumer in the middle and at the end of the pipe. This configuration corresponds to four linear connections with distributed consumers of 1 MW each, equaling a total connection load of 4 MW. Consequently, this 4 MW network exhibits identical heat distribution cost as the 1 MW network with linear connection of distributed consumers, i.e. of 1.99 c/kWh.

The described examples are strongly simplified, however describe the effect of the layout and the connection load qualitatively. Beside, additional layouts can be realised for large district heating systems such as loop networks and networks with more than one heat production site, which can reduce the effect of diseconomy. Nevertheless, the diseconomy of a linear expansion of district heating pipes, which becomes important when a reasonable number of radial connections is exhausted, clearly illustrates, that an optimisation of district heating systems need to consider the total cost resulting from heat production (which are often related to economy of scale) and of the heat distribution (related to diseconomy of scale).

Connection load/ Pipeline length	Network type	Module	
0.5 MW / 500 m			
Network type	Radial connection (ideal case)	Linear connection	
		1 consumer (worst case)	distributed consumers
1 MW / 1000 m			
2 MW / 2000 m			
4 MW / 4000 m			

LHD = 2 MWh/(a m) ■ Heat plant ● Consumer
 τ = 2000 h/a — Distribution network ⊗ Symbol in graph

Figure 21 Definition of different network expansions from 0.5 MW to 4 MW explained in the text.

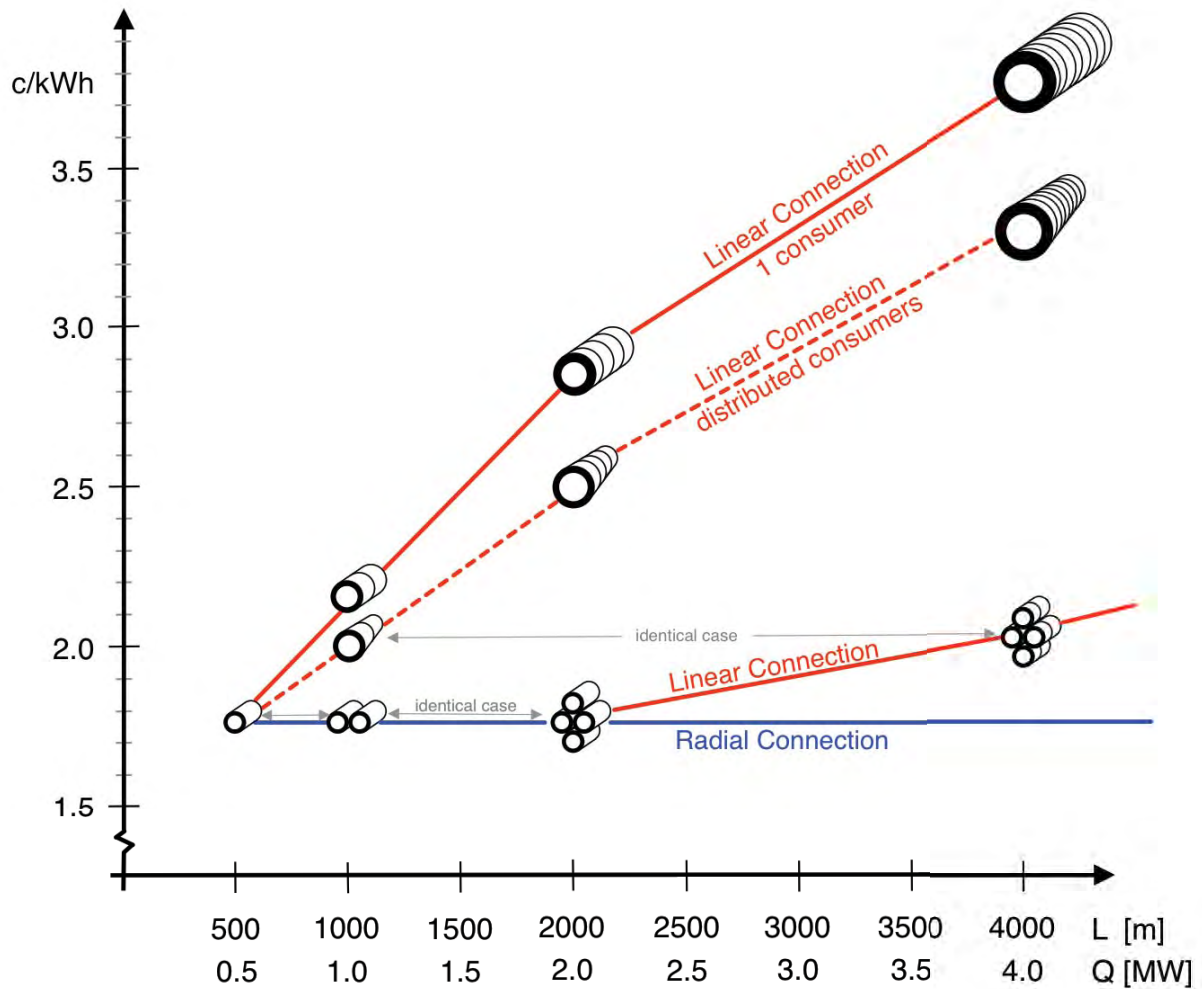

Figure 22 Heat distribution cost as function of the connection load and the pipeline length respectively for different network layouts at constant linear heat density of 2 MWh/(a m) and at an operation during 2000 full-load hours per year. The graph corresponds to the data displayed in Table 7.

Table 7 Heat distribution cost for different network expansions from 0.5 MW to 1 MW, 2 MW, and 4 MW according to Figure 21. The heat distribution cost are calculated for a constant linear heat density of 2 MWh/(a m) and for an operation during 2000 full-load hours of h/a.
 *The radial connection with 1 MW corresponds to 2 modules at identical cost as 1 module.
 **The radial connection with 2 MW corresponds to 4 modules at identical cost as 1 module.
 ***The 4 MW case “radial + linear” consists of four radial connections of 1 MW systems with linear connections of distributed consumers. Consequently these two cases exhibit identical cost of 1.99 c/kWh.

Connection Load / Pipeline Length	Heat distribution cost [c/kWh]		
	Radial connection (ideal case)	Linear connection	
		1 consumer (worst case)	Distributed consumers
0.5 MW / 500 m (= module)	1.77		
1 MW / 1000 m	1.77*	2.16	1.99
2 MW / 2000 m	1.77**	2.86	2.45
4 MW / 4000 m	linear	3.78	3.33
	radial + linear	1.99***	

6 Conclusions

6.1 Methodology

1. The heat distribution costs include capital cost, fuel cost to cover the heat losses, and electricity costs for pumping. External drivers are hence
 - the interest rate described by the annuity,
 - the fuel price and therefrom derived the price of heat production, and
 - the electricity price.
2. Since the cost factors mutually influence each other, the following applies:
 - In order to realise an economically profitable DH network, a comparison of the alternatives may be conducted. The main influencing factors consist of the location of the heat station, the size of the connected area, and the structure and type of network amongst others. The focus on only a few analysed alternatives limits the solutions, and it is hence not possible to determine the actual optimum of the network (in terms of a mathematically determined optimum).
 - Indications about heat distribution costs always apply to the respective network. For a given network, the heat distribution cost are determined as described in the present work as function of the design and operation parameters whose influence is evaluated by means of a sensitivity analysis. Within the given boundary conditions, the economically optimal design of the single parameters is hence possible.

6.2 Heat distribution cost

1. The model DH network with a connection load of 1 MW, pipeline length of 1000 m, and a network operation with 2000 full-load hours per year exhibits a linear heat density of 2 MWh per year and meter of pipeline length. In the case of an annual network operation with fuel costs of 4.15 c/kWh, electricity price of 16.5 c/kWh, and annuity of 5.1% p.a., **heat distribution costs of 2.16 cents per kWh distributed heat** are obtained assuming optimum design and low-cost pipe-laying conditions.
2. In this example, the **capital costs** have a share of **62%** and are hence mainly responsible of the total costs. The **fuel costs** amount to **24%** and the **electricity costs** to **14%**, whereas the latter are overestimated in the calculations.
3. If a larger pipe diameter than the smallest possible one is chosen, the capital costs and the heat distribution cost increase. Since the increase of capital costs is more pronounced, their share of the total cost even increases.
4. The heat distribution costs increase with increasing connection load and constant linear heat density, once the potential of radial expansion with increase of the number of main pipes is exhausted. Since the heat generation costs generally decrease with increasing load, a comparison of alternatives may help to optimise the size.

6.3 Network design

1. At small pipe diameters, the pressure drop and the pumping output as well as the electricity cost increase by a factor of two. In the studied example, the economically optimal nominal diameter is never larger than the smallest diameter required for avoiding inadmissible noise emissions. **In order to achieve economic optimisation, a network design at the smallest possible nominal diameter is hence decisive.** This requirement is even emphasised by the fact that the electricity cost are overestimated in the calculation since the network operation is assumed to be carried out at nominal load. The breakdown of the investment cost additionally shows that the capital costs are for their part dominated by pipe costs, i.e. already for DN 80 by 61% and 75% for pipe laying in the road and in open space, respectively. Since the excavation cost only marginally depend on the pipe diameter, they have an insignificant influence on the total cost. It should therefore be avoided to select larger pipe diameters than the smallest possible one for economic reasons also because the excavation costs remain almost identical.
2. In the examined example, the pipe dimensioning has the following effects:
 - One nominal size larger than the smallest necessary one increases the cost of heat distribution by 9%.
 - Two nominal sizes larger than the smallest necessary one increase the cost of heat distribution by 30%.

6.4 Sensitivity

Besides the design at the smallest diameter, the following factors are decisive:

1. A **large temperature difference** in order to allow small pipe diameters.
2. The lowest possible **specific investment costs** thanks to:
 - Ideal network structure considering the constructional boundary conditions,
 - Respective appropriate, low-price pipeline systems³.
3. A **high linear heat density** can contribute to low heat distribution cost since they decrease for a given network thanks to the following factors:
 - Increasing the **connection load** and
 - Increasing the **number of full-load hours** of the heat customers and hence of the heat generation.

Besides the above-mentioned factors, low return temperatures may contribute positively to the efficiency of heat generation. This is however not part of the present study.

³ In the evaluated model DH network, rigid plastic jacket pipes are examined. For specific applications, other systems such as flexible plastic carrier pipes may offer cheaper solutions. Other applications actually require more expensive systems.

The insulation class however has only marginal influence on the profitability and improvements in the insulation slightly increase the heat distribution cost. Nevertheless, maximum insulation is recommended because it is energetically and ecologically worthwhile and represents an asset in the case of increasing energy prices. Additionally, the choice of the right diameter has a much higher influence on the heat distribution cost than improved insulation.

The present calculations apply for favourable pipe-laying conditions. In the case of more costly constructional boundary conditions, the capital cost as well as their share of the total cost increase. The laying of pipes in roads results in roughly 20%-higher heat distribution costs for DN 80 and in roughly 15%-higher costs for DN 200.

7 Literature

- [1] Frederiksen, S.; Werner, S.: *District Heating and Cooling*, Studentlitteratur AB, Lund 2013, ISBN 978-91-44-08530-2
- [2] Arbeitsgemeinschaft für Wärme und Heizkraftwirtschaft: *AGFW-Hauptbericht 2010*, Frankfurt am Main 2011
- [3] Nussbaumer, T.; Thalmann, S.; Good, J.; Jenni, A.; Gabathuler, H.: *Analyse und Optimierung von Fernwärmenetzen – Vorstudie*, Swiss Federal Office of Energy, Bern 2012
- [4] Marek, R.; Nitsche, K.: *Praxis der Wärmeübertragung*, Carl Hanser, Munich 2007
- [5] Comakli, K.; Yüksel, B.; Comakli, Ö.: Evaluation of energy and exergy losses in district heating network, *Applied Thermal Engineering* 24 (2004) 1009–1017
- [6] Euroheat & Power: *Country by Country Statistics Overview 2013*, <http://www.euroheat.org/Statistics-69.aspx> (Accessed in January 2014)
- [7] Swiss Federal Office of Energy: *Schweizerische Gesamtenergiestatistik 2013*, Bern 2014
- [8] Thiemann, A.; Nussbaumer, T.: *Förderprogramm Fernwärme*, Schlussbericht, Bundesamt für Energie, Verenum Zürich, 11 March 2012
- [9] QM Holzheizwerke: *Planungshandbuch*, Schriftenreihe QM Holzheizwerke Volume 4, C.A.R.M.E.N. e.V., Straubing, 2nd edition 2008, ISBN 978-3-937441-94-8
- [10] Brugg Pipesystems: *Richtpreise Fernwärme-Rohre inkl. Verlegung und Tiefbau (personal communication)*, Kleindöttingen, 8 January 2010
- [11] Jenni, A.: *Personal communication*, Ardens GmbH, Liestal 2010
- [12] Österreichisches Kuratorium für Landtechnik und Landentwicklung: *ÖKL Merkblatt-Nr. 67 – Technisch-wirtschaftliche Standards für Biomasse-Fernheizwerke*, 1st edition, Wien 1999, 2nd edition, Vienna 2009, Status 2014: bulletin withdrawn
- [13] Ködel, J.: *Persönliche Kommunikation*, Gruneko, Basel, October 2013
- [14] Böswirth, L.: *Technische Strömungslehre*, 7th edition, Vieweg, Wiesbaden 2007
- [15] Dötsch C.; Taschenberger J.; Schönberg I.: *Leitfaden Nahwärme*, Fraunhofer-Institut für Umwelt, Sicherheits- und Energietechnik, UMSICHT-Schriftenreihe Band 6, Fraunhofer IRB Verlag Germany 1998, ISBN 3816751865