

IEA Solar Heating &  
Cooling Programme  
Task 37: Fortschrittliche  
thermische Gebäudesanierung

T. Mach, R. Heimrath

Berichte aus Energie- und Umweltforschung

**57/2010**

## **Impressum:**

Eigentümer, Herausgeber und Medieninhaber:  
Bundesministerium für Verkehr, Innovation und Technologie  
Radetzkystraße 2, 1030 Wien

Verantwortung und Koordination:  
Abteilung für Energie- und Umwelttechnologien  
Leiter: DI Michael Paula

Liste sowie Downloadmöglichkeit aller Berichte dieser Reihe unter  
<http://www.nachhaltigwirtschaften.at>

# IEA Solar Heating & Cooling Programme Task 37: Fortschrittliche thermische Gebäudesanierung

DI Dr. Thomas Mach, DI Dr. Richard Heimrath,  
Institut für Wärmetechnik (IWT), Technische Universität Graz

Projektverantwortung am Institut für Wärmetechnik  
Univ. Prof. Dr. Wolfgang Streicher



Graz, August 2010

Ein Projektbericht im Rahmen der Programmlinie

IEA FORSCHUNGS  
KOOPERATION

Impulsprogramm Nachhaltig Wirtschaften

Im Auftrag des Bundesministeriums für Verkehr, Innovation und Technologie





## Vorbemerkung

Der vorliegende Bericht dokumentiert die Ergebnisse eines Projekts aus dem Programm FORSCHUNGSKOOPERATION INTERNATIONALE ENERGIEAGENTUR. Es wurde vom Bundesministerium für Verkehr, Innovation und Technologie initiiert, um Österreichische Forschungsbeiträge zu den Projekten der Internationalen Energieagentur (IEA) zu finanzieren.

Seit dem Beitritt Österreichs zur IEA im Jahre 1975 beteiligt sich Österreich aktiv mit Forschungsbeiträgen zu verschiedenen Themen in den Bereichen erneuerbare Energieträger, Endverbrauchstechnologien und fossile Energieträger. Für die Österreichische Energieforschung ergeben sich durch die Beteiligung an den Forschungsaktivitäten der IEA viele Vorteile: Viele Entwicklungen können durch internationale Kooperationen effizienter bearbeitet werden, neue Arbeitsbereiche können mit internationaler Unterstützung aufgebaut sowie internationale Entwicklungen rascher und besser wahrgenommen werden.

Dank des überdurchschnittlichen Engagements der beteiligten Forschungseinrichtungen ist Österreich erfolgreich in der IEA verankert. Durch viele IEA Projekte entstanden bereits wertvolle Inputs für europäische und nationale Energieinnovationen und auch in der Marktumsetzung konnten bereits richtungsweisende Ergebnisse erzielt werden.

Ein wichtiges Anliegen des Programms ist es, die Projektergebnisse einer interessierten Fachöffentlichkeit zugänglich zu machen, was durch die Publikationsreihe und die entsprechende Homepage [www.nachhaltigwirtschaften.at](http://www.nachhaltigwirtschaften.at) gewährleistet wird.

Dipl. Ing. Michael Paula

Leiter der Abt. Energie- und Umwelttechnologien

Bundesministerium für Verkehr, Innovation und Technologie



## Kurzfassung

Motivation	Gebäude verursachen ca. 35% des Energieverbrauchs der von der Internationalen Energieagentur (IEA) erfassten Länder. Wohngebäude haben hierbei einen hohen Anteil. Wird die Entscheidung für eine thermische Gebäude- und Anlagen-sanierung getroffen, so lassen sich hohe Energieeinsparungen pro Gebäude realisieren. Wird hingegen weniger ambitioniert saniert, so sind hohe Einsparpotentiale meist auf Jahrzehnte hinaus verloren. Aus diesem Grund ist das Wissen wie durch Sanierungen bzw. Modernisierungen energetisch hocheffiziente Gebäude entstehen essentiell um das theoretische Energieeinsparungspotential auch tatsächlich aktivieren zu können.
Ansatz	Vor diesem Hintergrund startete der Task 37 "Fortschrittliche thermische Gebäudesanierung" im Implementing Agreement „Solar heating and cooling“ (SHC) der Internationalen Energieagentur (IEA) im Juli 2006 sein dreieinhalb jähriges Programm. Das Ziel lag in der Arbeit an fortschrittlichen Konzepten zur hochwertigen Sanierung von Wohngebäuden. Expertenteams (in Summe über 50 Personen) aus zehn europäischen Ländern, aus Kanada und aus Neuseeland trafen sich unter norwegischer Leitung halbjährlich zum gegenseitigen Austausch in jeweils zwei bis dreitägigen Meetings. Die österreichische Beteiligung, bezeichnet als Team Austria, setzte sich aus Experten aus Universitätsinstituten bzw. anderen Forschungseinrichtungen und aus Bauschaffenden zusammen. Team Austria war an der Arbeit von drei der vier Subtasks beteiligt.
Subtask A	Subtask A beschäftigte sich mit der Analyse von Gebäudesektoren mit großen Energieeinsparungspotentialen. In Zusammenarbeit von Firmen, Entscheidungsträgern und Forschungsorganisationen wurden zudem Marketingsstrategien zur verstärkten Verbreitung hochwertiger Sanierungen erarbeitet. Aus Österreich flossen Erfahrungsberichte, Diskussionsteilnahmen und Daten über den österreichischen Gebäudebestand ein.
Subtask B	In diesem Subtask wurden 60 erfolgreich durchgeführte Sanierungsvorhaben einer energetischen Bewertung unterzogen, erfolgsversprechende Konzepte und Einzelmaßnahmen aufgefunden gemacht, systematisch analysiert und dokumentiert. Zwölf hochwertige österreichische Sanierungsvorhaben von Wohngebäuden, mit einem Fokus auf Projekte aus der Programmlinie „Haus der Zukunft“, wurden in den Task eingebracht, mit den internationalen Experten diskutiert und einer Queranalyse unterzogen.
Subtask C	Dieser Subtask fokussierte sich auf technische Lösungen für Sanierungspakete zur Erreichung substantieller Primärenergieeinsparung und Nutzung erneuerbarer Energie. Dabei wurden neue technische Komponenten und Systeme beschrieben und in der Form von Handbüchern publiziert. Die österreichischen Beiträge bezogen sich auf Erfahrungen zu Bewohner-Beteiligungsprozessen bei Sanierungen, auf die Integration solarthermischer Systeme und kontrollierter Be- bzw. Entlüftungssysteme, sowie auf Innendämmungen aus Zellulose.
Resümee	Neben den offiziellen Ergebnisdokumenten wurden in einer Reihe von Meetings, Symposien und Exkursionen die österreichischen Erfahrungen in den Task eingebracht, sowie die internationalen Erfahrungen aus dem Task österreichischen Akteuren zugänglich gemacht. Es hat sich gezeigt, dass sowohl die Problemstellungen der teilnehmenden europäischen Länder, als auch die Lösungsansätze sehr ähnlich gelagert sind. Somit war die gemeinsame Basis vorhanden um generelle Erfahrungswerte auszutauschen bzw. technisches Fachwissen zu erarbeiten. Es wird daher angestrebt die erfolgreich durchgeführte Zusammenarbeit in einem Nachfolgetask im Themenbereich „Nichtwohngebäude“ weiterzuführen.

## Abstract

motivation	Buildings are responsible for up to 35 percent of the total energy consumption in many of the IEA participating countries. Housing accounts for the greatest part of the energy use in this sector. Once the decision for a building renovation is made, the potential for high energy savings are given. If the renovation is implemented on a low ambition level, high potential savings are lost for decades. For this reason, the knowledge about renovation on a high ambition level concerning energy efficiency is essential to maximize the energy saving caused by building renovation and building modernization.
approach	Based on this Task 37 “Advanced Housing Renovation with Solar & Conservation“ was started in July 2006 as a project of the Implementing Agreement „Solar heating and cooling“ (SHC) within the International Energy Agency (IEA). The aim of Task 37 was the development of advanced renovation concepts for residential buildings. Ten European Countries, Canada and New Zealand nominated experts who met each other in biannual organized meetings and conferences. More than 50 involved experts worked for three and a half year on concepts for high ambition level renovation focused on residential buildings. The Austrian participation, named “Team Austria” included institutes from universities, research companies and architects. Team Austria contributed in three of four Subtasks.
Subtask A	In Subtask A (Marketing and Communication Strategies) the buildings stocks of the participating countries were analysed to find housing segments with high potentials for energy saving. In co-operation of companies, policy makers and research organizations marketing strategies for increasing the market penetration of high level renovation have been developed. Team Austria contributed in the discussions and prepared analysis about the Austrian building stock.
Subtask B	In this Subtask, 60 successfully completed renovation projects were analysed due to their energy performance. Promising approaches and specific measures have been identified and systematically analyzed and documented. Twelve high-quality Austrian residential renovation projects, with a focus on projects from the program "Building of Tomorrow", were placed in the Task and discussed with international experts.
Subtask C	This Subtask focused on technical solutions for building and building service renovation packages to achieve substantial primary energy savings including especially renewable energy. New technical components and systems were described and published in the form of manuals. The Austrian contributions dealt with participation of residents in the renovation process, the integration of solar thermal systems and controlled ventilation, as well as interior insulation made of cellulose.
résumé	Beside the outcome documents, Team Austria worked in numerous meetings, symposia and excursions to deliver Austrian experiences to the international group of experts, as well as international experiences reached the Austrian experts. It has been shown that the problems of the participating European countries, as well as the traced approaches are very similar to each other. Therefore the common basis for the exchange of valuable information and the development of technical solutions was given. The aim is to continue the successful cooperation in a new Task devoted to the topic "Non-residential buildings".

# Inhalt

<b>1</b>	<b>Das Projekt IEA SHC TASK 37</b>	<b>6</b>
1.1	Motivation und Zielsetzung.....	7
1.2	Inhaltliche und organisatorische Struktur .....	7
1.3	Die TASK 37 Expertengruppe .....	8
1.1	Meetings, Konferenzen, Exkursionen.....	10
1.4	weiterführende Informationen.....	11
<b>2</b>	<b>Die österreichische Beteiligung</b>	<b>12</b>
2.1	Zielsetzungen der österreichischen Teilnahme .....	13
2.2	Bildung von Team Austria .....	13
2.3	Involvierte Personen Team Austria .....	15
2.4	Bilanz der durchgeführten Aktivitäten.....	18
<b>3</b>	<b>Die Arbeit in den Subtasks</b>	<b>21</b>
3.1	Subtask A - Marketing und Kommunikation .....	22
3.2	Analyse des österreichischen Gebäudebestandes .....	22
3.3	Subtask B - Analyse herausragender Projekte .....	25
3.4	Kurzbeschreibungen der zwölf eingebrachten Sanierungsprojekte .....	27
3.5	Queranalyse der österreichischen Projekte .....	40
3.6	Subtask C - Konzept- und Komponentenanalyse .....	43
3.7	Die österreichischen Fachbeiträge.....	44
3.8	Subtask D - Bewertung der Umweltwirkung.....	46
<b>4</b>	<b>Ausblick</b>	<b>47</b>

**ANHANG - Beiträge zu Subtask A**

**ANHANG - Beiträge zu Subtask B**

**ANHANG - Beiträge zu Subtask C**

# 1 Das Projekt IEA SHC TASK 37

Zielsetzung, Struktur und Aktivitäten

## 1.1 Motivation und Zielsetzung

Gebäude sind für ca. 35 % des Energieverbrauchs der Länder verantwortlich, die von der Internationalen Energieagentur (IEA) erfasst werden. Wohngebäude haben hierbei einen hohen Anteil. Wird einmal die Entscheidung für eine thermische Gebäude und Anlagensanierung getroffen, so lassen sich hohe Energieeinsparungen je Gebäude realisieren. Wird hingegen weniger ambitioniert saniert, so sind die Einsparungen auf Jahrzehnte hinaus verloren. Aus diesem Grund ist das Wissen über energetisch und ökonomisch effiziente Sanierung essentiell um das bei Gebäudesanierungen vorhandene Energieeinsparungspotential optimal nutzen zu können.

Das Ziel des TASK 37 liegt in der Entwicklung von fortschrittlichen Konzepten zur hochwertigen Sanierung von Wohngebäuden. Für die Gebäudesektoren mit den größten Energieeinsparungspotentialen werden Strategien zu einer verstärkten Marktdurchdringung hochwertiger Sanierungen untersucht. Die Analyse von wegweisenden Sanierungsvorhaben soll, unter Bedachtnahme auf die Nachhaltigkeit, zu technisch und wirtschaftlich robusten Sanierungskonzepten führen.

## 1.2 Inhaltliche und organisatorische Struktur

Operating Agent: Fritjof Salvesen, fs@kanenergi.no, NO

### Subtask A: **Marketing and Communication Strategies**

Subtask Leader: Are Rodsjo, are.rodsjo@husbanken.no, NO

Dieser Subtask beschäftigt sich mit der Analyse von Gebäudesektoren mit großen Energieeinsparungspotentialen. In Zusammenarbeit von Firmen, Entscheidungsträgern und Forschungsorganisationen werden Marketingstrategien zur verstärkten Verbreitung hochwertiger Sanierungen erarbeitet.

### Subtask B **Advanced Projects Analyses**

Subtask Leader: Robert Hastings, robert.hastings@aeu.ch, CH

In diesem Subtask werden erfolgreich durchgeführte Sanierungsvorhaben einer energetischen und ökonomischen Bewertung unterzogen. Erfolgsversprechende Konzepte und Einzelmaßnahmen werden ausfindig gemacht und systematisch analysiert und dokumentiert.

### Subtask C **Analysis and Concepts**

Subtask Leader: Sebastian Herkel, sebastian.herkel@ise.fraunhofer.de, DE

Im Rahmen von Subtask C werden optimierte Sanierungspakete zur Erreichung substantieller Primärenergieeinsparung und Nutzung erneuerbarer Energie ausgearbeitet. Dabei soll die Effektivität von neuen technischen Komponenten und Systemen in Bezug auf Energie, Ökonomie und Ökologie betrachtet werden.

### Subtask D **Environmental Impact Assessment**

Subtask Leader: Sophie Trachte, sophie.trachte@archi2000.be, BE

Subtask D bewertet durchgeführte Sanierungsvorhaben und erarbeitet einen Leitfaden zur Bewertung von Sanierungskonzepten in Hinblick auf deren qualitativen und quantitativen Beitrag zur Nachhaltigkeit.

**Dauer**

Beginn: 1. Juli 2006

Abschluss: 31. Dezember 2009

**Teilnehmende Staaten**

Belgien, Dänemark, Deutschland, Italien, Neuseeland, Niederlande, Norwegen, Österreich, Schweden, Schweiz, Kanada, Finnland

### 1.3 Die TASK 37 Expertengruppe

Im Zuge der dreieinhalb jährigen Laufzeit ergab sich eine stetige Zunahme interessierter Experten. Bis zum letzten Projektjahr (2009) stieg die Anzahl auf über 50 aktiver Task 37 Experten. Fig. 1 zeigt die TeilnehmerInnen des Abschlussmeetings in Antwerpen und Fig. 2 zeigt eine Auflistung aller am TASK 37 Experten.



*Fig. 1: Gruppenfoto im Rahmen des Treffens mit dem Vizebürgermeister von Antwerpen*



<b>Thomas Mach</b>	Graz University of Technology	AT
<b>Wolfgang Streicher</b>	Graz University of Technology	AT
<b>Richard Heimrath</b>	Graz University of Technology	AT
<b>Markus Michlmair</b>	Graz University of Technology	AT
<b>Claudia Dankl</b>	Österr. Gesellschaft für Umwelt und Technik	AT
<b>Anita Preisler</b>	arsenal research	AT
<b>Wolfgang Leitzinger</b>	arsenal research	AT
<b>Olivier Pol</b>	arsenal research	AT
<b>Herbert Greisberger</b>	Österr. Gesellschaft für Umwelt und Technik	AT
<b>Sigrun Rottensteiner</b>	Graz University of Technology	AT
<b>Sophie Grünewald</b>	Graz University of Technology	AT
<b>Sophie Trachte</b>	Architecture et Climat	BE
<b>Andre De Herde</b>	Université Catholique de Louvain	BE
<b>Wouter Hilderson</b>	Passiefhuis-Platform	BE
<b>Erwin Mlecnik</b>	Passiefhuis-Platform	BE
<b>Sabrina Prieus</b>	Belgian Building Research Institute	BE
<b>Luk Vandaele</b>	Belgian Building Research Institute	BE
<b>Jeroen Vrijders</b>	Belgian Building Research Institute	BE
<b>Robert Hastings</b>	AEU GmbH	CH
<b>Andreas Gütermann</b>	Amena ag	CH
<b>Nadja Grischott</b>	Beat Kämpfen – Büro für Architektur	CH
<b>Beat Kämpfen</b>	Beat Kämpfen – Büro für Architektur	CH
<b>Olaf Bruun Jørgensen</b>	Esbensen Consulting Engineers A/S	DK
<b>Peter Juhl</b>	Esbensen Consulting Engineers A/S	DK
<b>Sebastian Herkel</b>	Fraunhofer - Inst. Solar Energy Systems	DE
<b>Markus Kratz</b>	Forschungszentrum Jülich – PTJ	DE
<b>Johann Reiss</b>	Fraunhofer - Inst. Bauphysik	DE
<b>Florian Kagerer</b>	Fraunhofer - Inst. Solar Energy Systems	DE
<b>Berthold Kaufmann</b>	Passivhaus Institut	DE
<b>Wolfgang Hasper</b>	Passivhaus Institut	DE
<b>Mia Ala-Juusela</b>	VTT	FI
<b>Valerio Calderaro</b>	University La Sapienza of Roma	IT
<b>Chiel Boonstra</b>	Trecodome	NL
<b>Erik Franke</b>	Franke Architekten B.V.	NL
<b>Henk F. Kaan</b>	Energy Research Centre of the Netherlands	NL
<b>Ivo J. Opstelten</b>	Energy Research Centre of the Netherlands	NL
<b>Edward Prendergast</b>	moBius consult	NL
<b>Tor Helge Dokka</b>	SINTEF Building and Infrastructure	NO
<b>Trond Haavik</b>	Segel AS	NO
<b>Synnøve Aabrekk</b>	Segel AS	NO
<b>Are Rødsjø</b>	Norwegian State Housing Bank	NO
<b>Fritjof Salvesen</b>	KanEnergi AS	NO
<b>Ulla Hahn</b>	Arkitektkontoret Lene Frank as	NO
<b>Michael Klinski</b>	SINTEF Buildings and Infrastructure	NO
<b>Anne Gunnarshaug Lien</b>	Enova SF	NO
<b>Gry Kongsli</b>	Norwegian State Housing Bank	NO
<b>Marit Thyholt</b>	SINTEF Buildings and Infrastructure	NO
<b>Ulla Janson</b>	Lund University- Energy and Building Design	SE
<b>Björn Berggren</b>	Skanska Sweden AB/Skanska Technology	SE
<b>Albrecht Stoecklein</b>	Meridian Efficiency	NZ
<b>Lynda Amitrano</b>	Branz	NZ
<b>Paul Parker</b>	University of Waterloo; Fac. of Environment	CA
<b>Anil Parekh</b>	Canmet ENERGY Natural Resources CA	CA

Fig. 2: TASK 37 Expertengruppe nach Auflistung des Operating Agents Fritjof Salvesen

## 1.1 Meetings, Konferenzen, Exkursionen

Nach einer relativ langen Vorlaufphase in der die inhaltliche und organisatorische Ausrichtung in einem „Definition Meeting“ und einem „Final Planning Workshop“ heftig diskutiert wurde, startete der TASK 37 offiziell am 1. Juli 2006. Darauf folgten sieben Expert Meetings, drei Technical Tours und ein Workshop.

### Expert Meetings und assoziierte Veranstaltungen

---

#### **Definition Meeting**

20. Mai 2005 in Wien (Österreich)

#### **Final Planning Workshop**

24. - 25 April 2006 in Louvain la Neuve (Belgien)

#### **First Expert Meeting**

Technical Tour am 27. September 2006

Meeting am 28.- 29. September 2006 in Mannheim (Deutschland)

#### **Second Expert Meeting**

Meeting 17.- 18. April 2007 in Wallisellen (Schweiz)

#### **Third Expert Meeting**

Meeting am 17.- 18. Oktober 2007 in Wien (Österreich)

Technical Tour am 19. Oktober 2007 in Wien (Österreich)

#### **Fourth Expert Meeting**

Meeting am 17.- 18. April 2008 in Haarlem (Niederlande)

#### **Fifth Expert Meeting**

Meeting am 23.- 24. September 2008 in Trondheim (Norwegen)

International conference, Trondheim 25. September 2008

#### **Sixth Expert Meeting**

Conference am 19. Mai 2009 in Waterloo (Kanada)

Meeting am 21.- 22. Mai 2009 in Waterloo (Kanada)

#### **Seventh Expert Meeting**

symposium and fieldtrip am 13. Okt. 2009 in Roosendaal (NL)

Cross Task Conference am 14. Oktober 2009 in Antwerpen (Belgien)

Meeting am 15-16. Oktober 2009 in Antwerpen (Belgien)

## 1.4 weiterführende Informationen

Eine Übersicht über die in der internationalen Expertengruppe bearbeiteten Inhalte zeigt der Flyer von dem in Fig. 3 das Cover dargestellt ist. Weiterführende Informationen und die entsprechenden Ergebnisdokumente sind auf der Homepage des TASK 37 und zu finden:

<http://www.iea-shc.org/task37/index.html>

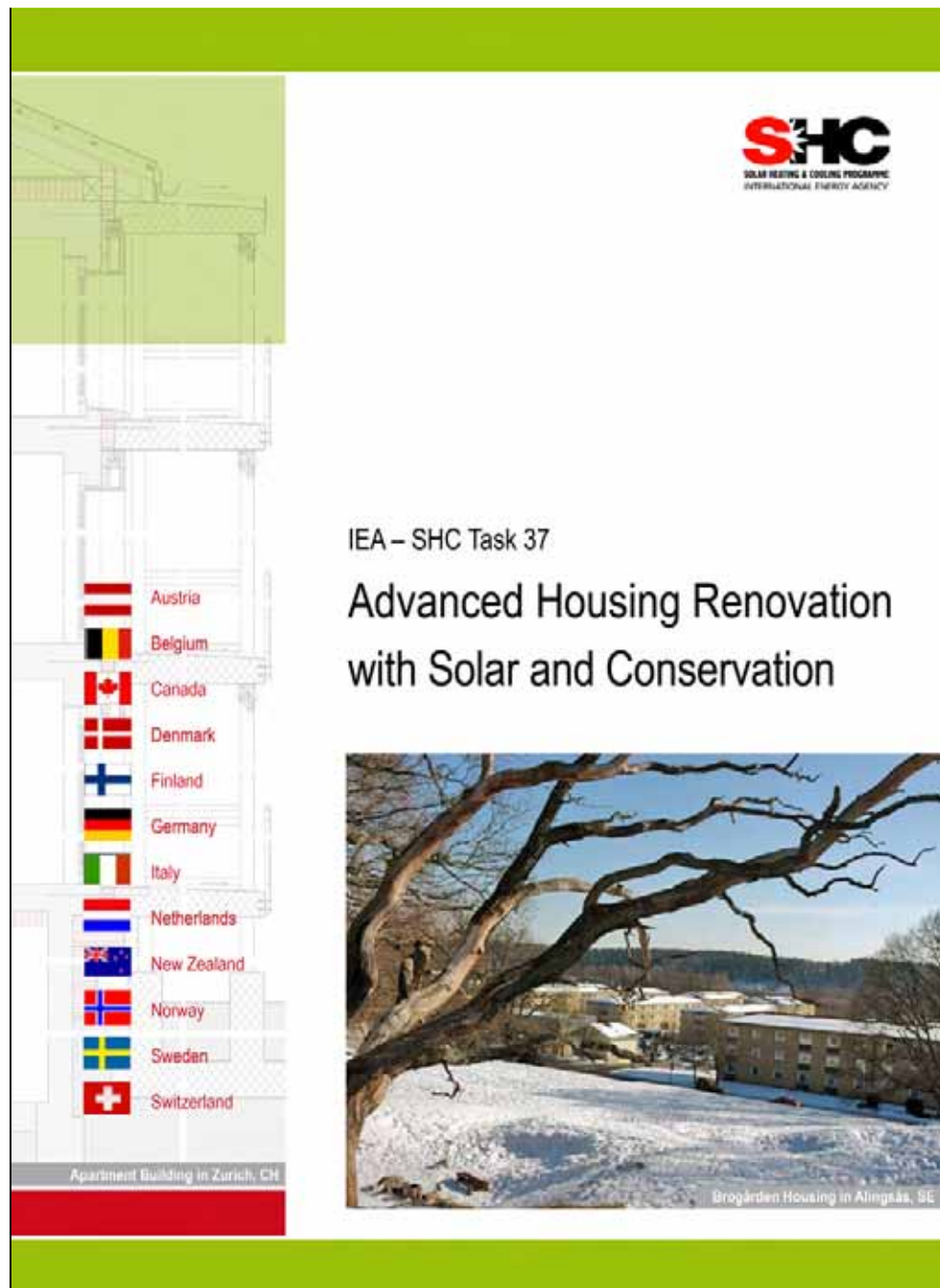

Fig. 3: Cover des Flyers zum IEA SHC Task 37

## **2 Die österreichische Beteiligung**

Zielsetzung und Bilanz der Aktivitäten

## 2.1 Zielsetzungen der österreichischen Teilnahme

### Vernetzungsaktivitäten und Informationsaustausch

Durch die Teilnahme Österreichs sollen österreichische Sanierungsvorhaben und Forschungsprojekte auf dem Gebiet der hochwertigen Sanierung von Wohngebäuden, mit einem Fokus auf Projekte aus der Programmlinie „Haus der Zukunft“, in den TASK 37 eingebracht und mit der internationalen Expertengruppe diskutiert werden. Auf der anderen Seite sollen die gewonnenen internationalen Erfahrungen aus den Task Ergebnissen wiederum den österreichischen Akteuren in diesem Bereich zugänglich gemacht werden. Dieser Zielsetzung wurde ein detaillierter Arbeitsplan für die Zuteilung der inhaltlichen und organisatorischen Arbeiten hinterlegt. Dieser Arbeitsplan bildete die Grundlage für die Aktivitäten der teilnehmenden österreichischen Organisationen.

### Fachliche Arbeitsfelder

Auf der inhaltlichen Ebene war das grundlegende Arbeitsgebiet, die energetisch und ökologisch hochwertige Sanierung von Wohnbauten, in die folgenden Arbeitsfelder gegliedert:

- 1) **Arbeit am Umfeld von Sanierungsvorhaben**  
Betrachtung der Rahmenbedingungen die zu hochwertigen Sanierungen führen (Förderungen, Finanzierung, Image, Bauvorschriften, Markt, etc.)  
Diese Aktivitäten waren im Wesentlichen in SUBTASK A angesiedelt.
- 2) **Arbeit an Gebäudekonzepten**  
Evaluierung, Analyse und Publikation umgesetzter „best practise“ Sanierungen (Qualitative Analyse, Berechnung, Konstruktion, Messung)  
Diese Aktivitäten waren im Wesentlichen in SUBTASK B angesiedelt.
- 3) **Arbeit an baulichen bzw. gebäudetechnischen Komponenten**  
Evaluierung, Analyse und Publikation einzelner technischer Komponenten im Bereich der baulichen Substanz bzw. gebäudetechnischer Einrichtungen  
Diese Aktivitäten waren im Wesentlichen in SUBTASK C angesiedelt.

## 2.2 Bildung von Team Austria

Bei der Erfüllung der oben genannten Zielsetzung wurde auf das Fachwissen und die Mitarbeit einer breiten Basis gesetzt. Die Einbeziehung unterschiedlichster Akteure auf dem Gebiet der thermischen Sanierung soll das Fachwissen von Forschungsinstitutionen und Bauschaffenden miteinander vernetzen. Daher setzt sich die österreichische Beteiligung aus Universitätsinstituten, Forschungseinrichtungen, dem Projektkoordinator der Programmlinie Haus der Zukunft und Bauschaffenden zusammen. Die Summe aller österreichischen Beteiligten wird als „Team Austria“ bezeichnet. Neben den vier im Antrag vertretenen Institutionen konnten bisher drei Architekturbüros im Sinne der Vernetzung in die Arbeiten einbezogen werden. Das Team Austria setzt sich aus folgenden Institutionen zusammen:

Institutionen im Antragsteam:

---

Institut für Wärmetechnik  
Technische Universität Graz  
Inffeldgasse 25 B, A- 8010 Graz  
[www.iwt.tugraz.at](http://www.iwt.tugraz.at)



Österreichische Gesellschaft  
für Umwelt und Technik  
Hollandstraße 10/46, A-1020 Wien  
[www.oegut.at](http://www.oegut.at)



Arsenal Research  
Geschäftsfeld Nachhaltige Energiesysteme  
Giefinggasse 2, A-1210 Wien  
[www.arsenal.ac.at](http://www.arsenal.ac.at)



AEE INTEC  
Institut für Nachhaltige Technologien  
Feldgasse 19, A-8200 Gleisdorf  
[www.aee-intec.at](http://www.aee-intec.at)



Arsenal Research ist im Laufe der Projektlaufzeit in das neugegründete Austrian Institute of Technology aufgenommen worden. Aus diesem Grund wurde das Logo von Arsenal Research in den Endpräsentationen durch das AIT-Logo ersetzt.



weitere eingebundene Institutionen (sortiert nach Einbindungszeitpunkt):

---

Architekturbüro Reinberg ZT GmbH  
Lindengasse 39/10, A-1070 Wien  
[www.reinberg.net](http://www.reinberg.net)

Arch+More ZT GmbH  
Filiiale Haseneck 7, A-4048 Linz/Puchenu  
[www.arch-more.com](http://www.arch-more.com)

pos architekten ZT-KEG  
Maria Treu Gasse 3/15, A-1080 Wien  
[www.pos-architecture.com](http://www.pos-architecture.com)

Institut für Gebäudelehre  
Technische Universität Graz  
Lessingstraße 25/IV, 8010 Graz  
<http://www.gl.tugraz.at/>

Institut für Hochbau und Bauphysik  
Technische Universität Graz  
Lessingstraße 25/III, 8010 Graz  
[www.ihb.tugraz.at](http://www.ihb.tugraz.at)

Architektur- und Planungsbüros der Demoprojekte  
genannt in den Broschüren

## 2.3 Involvierte Personen Team Austria

Im Sinne der angestrebten Vernetzung der österreichischen Akteure wurden möglichst viele Personen in die inhaltliche Arbeit miteinbezogen. Die Abkürzungen neben den Personennamen werden im Tätigkeitsbericht verwendet um einzelnen Aktivitäten Personen zuordnen zu können:

### Projektleitung und „National Contact Person“:

(TMA) **Dr. Thomas Mach**  
Institut für Wärmetechnik  
Technische Universität Graz  
Inffeldgasse 25 B, A- 8010 Graz  
Tel.: (+43) 316 873 7814  
thomas.mach@tugraz.at

### Projektverantwortung am IWT:

(WS) **Ao. Prof. Dr. Wolfgang Streicher**  
Institut für Wärmetechnik  
Technische Universität Graz  
Inffeldgasse 25 B, A- 8010 Graz  
Tel.: (+43) 316 873 7306  
w.streicher@tugraz.at

### « Confirmed » Experts gemäß (Participation Letter):

(HG) **Dr. Herbert Greisberger**  
Österreichische Gesellschaft für Umwelt und Technik– ÖGUT  
Hollandstraße 10/46, A-1020 Wien  
Tel +43.1.315 63 93  
office@oegut.at

(AP) **Ing. Anita Preisler**  
Austrian Institute of Technology (vormals Arsenal Research)  
Geschäftsfeld Nachhaltige Energiesysteme  
Giefinggasse 2, A- 1210 Wien  
Tel.: +43 (0) 50550-6634  
anita.preisler@arsenal.ac.at

(WW) **Ing. Wagner Waldemar**  
AEE INTEC - Institut für Nachhaltige Technologien  
Feldgasse 19, A- 8200 Gleisdorf  
Tel.: +43 (0)3112 5886-60, Fax: -18  
w.wagner@aee.at

### Experts:

(OP) **DI Olivier Pol**  
Austrian Institute of Technology (vormals Arsenal Research)  
Geschäftsfeld Nachhaltige Energiesysteme  
Giefinggasse 2, A- 1210 Wien  
Tel.: +43 (0) 50550-6592  
olivier.pol@arsenal.ac.at

- (CD) **DI Claudia Dankl**  
Österreichische Gesellschaft für Umwelt und Technik – ÖGUT  
Hollandstraße 10/46, A-1020 Wien  
T: +43.1.315 63 93-24  
claudia-dankl@oegut.at
- (WR) Prof. **DI Georg Wolfgang Reinberg**, M. Arch.  
Architekturbüro Reinberg ZT GmbH  
Lindengasse 39/10, , A- 1070 Wien  
Telefon: +43 - (0)1 - 524 82 80  
architekt@reinberg.net
- (RP) **DI Rudolf Passawa**, MAS  
Department für Bauen und Umwelt  
Donau-Universität Krems  
Dr.-Karl-Dorrek-Straße 30, A-3500 Krems  
Büro: 0043/ 2732/ 893-2667  
rudolf.passawa@donau-uni.ac.at
- (IDM) Arch. **DI Ingrid Domenig-Meisinger**  
Arch+More ZT GmbH  
Filiale: Haseneck 7  
A- 4048 Puchenu/Linz  
Tel.: 0732 604508-11  
domenig@arch-more.com
- (RH) Dr. **Richard Heimrath**  
Institut für Wärmetechnik  
Technische Universität Graz  
Inffeldgasse 25 B, A- 8010 Graz  
Tel.: (++43) 316 873 7317  
heimrath@tugraz.at
- (AP) Ing. **Wolfgang Leitzinger**  
Austrian Institute of Technology (vormals Arsenal Research)  
Geschäftsfeld Nachhaltige Energiesysteme  
Giefinggasse 2, A- 1210 Wien  
Tel.: +43 (0) 50550-6613  
wolfgang.leitzinger@arsenal.ac.at
- (TM) **DI Thomas Müller**  
AEE INTEC  
Feldgasse 19, A- 8200 Gleisdorf  
Phone.: +43-3112 / 5886 16
- (FO) Arch. **DI Fritz Oettl**  
pos architekten ZT-KEG  
Maria Treu Gasse 3/15, A-1080 Wien  
Tel.: +43(0)1-4095265-10  
oettl@pos-architecture.com
- (PP) Dr. **Peter Puschnig**  
Institut für Wärmetechnik  
Technische Universität Graz  
Inffeldgasse 25 B, A- 8010 Graz  
Tel.: (++43) 316 873 7314  
puschnig@tugraz.at



- (MM) **DI Markus Michlmair**  
Institut für Wärmetechnik  
Technische Universität Graz  
Inffeldgasse 25 B, A- 8010 Graz  
Tel.: (+43) 316 873 7312  
markus.michlmair@tugraz.at
- (SR) **DI Sigrun Rottensteiner**  
freie Mitarbeiterin Institut für Gebäudelehre  
Technische Universität Graz  
sigrun.rottensteiner@alumni.tugraz.at
- (SG) **DI Sophie Grünewald**  
Institut für Gebäudelehre  
Technische Universität Graz  
s.gruenewald@tugraz.at
- (HG) **Univ.-Prof. Dipl.-Ing. Architekt Hans Gangoly**  
Institut für Gebäudelehre  
Technische Universität Graz  
Lessingstraße 25/IV, 8010 Graz  
Tel.: (+43) 316 873 6290  
gangoly@tugraz.at
- (AH) **Dr. Andreas Heinz**  
Institut für Wärmetechnik  
Technische Universität Graz  
Inffeldgasse 25 B, A- 8010 Graz  
Tel.: (+43) 316 873 7313  
Andreas.heinz@tugraz.at
- (HH) **DI Herwig Hengsberger**  
Institut für Hochbau und Bauphysik  
Technische Universität Graz  
Lessingstraße 25/III, 8010 Graz  
Tel.: (+43) 316 873 6745  
hengsberger@tugraz.at
- (PK) **Univ.-Prof. DDr. Peter Kautsch**  
Institut für Hochbau und Bauphysik  
Technische Universität Graz  
Lessingstraße 25/III, 8010 Graz  
Tel.: (+43) 316 873 6240  
kautsch@tugraz.at
- (CF) **Ing. Christian Fink**  
AEE INTEC - Institut für Nachhaltige Technologien  
Feldgasse 19, A- 8200 Gleisdorf  
Tel.: +43 (0)3112 5886-14, Fax: DW 18  
c.fink@aee.at

## 2.4 Bilanz der durchgeführten Aktivitäten

### Bilanz – Vernetzungsaktivitäten und Informationsaustausch

Aus den Zielvorgaben und dem Arbeitsplan ergeben sich im Bereich „Vernetzungsaktivitäten und Informationsaustausch“ zwei zentrale Zielsetzungen der österreichischen Teilnahme am Task 37. Einerseits sollten Vernetzungsaktivitäten zwischen österreichischen Experten und den internationalen Experten des Task angestoßen bzw. weiterentwickelt werden und andererseits sollten die Ergebnisse des nationalen Forschungsprogrammes „Haus der Zukunft“ in Aktivitäten der Internationalen Energieagentur eingebunden werden um die internationale Verbreitung der diesbezüglich in Österreich geleisteten Forschungsarbeit zu stärken.

### Bilanz Vernetzung

Die Anzahl der österreichischen, unmittelbar in die Task Arbeit eingebundenen Akteure, wuchs im Laufe des Projektes auf über 20 Personen an, wobei davon 15 verschiedene Personen zumindest an einem Expert Meeting teilgenommen haben und somit die Möglichkeiten wahrnehmen konnten sich mit der internationalen Expertengruppe auszutauschen. Auf institutioneller Ebene wurden zusätzlich zu den Antragsinstitutionen (Institut für Wärmetechnik, Österreichische Gesellschaft für Umwelt und Technik, Arsenal Research, AEE Institut für Nachhaltige Technologien) weitere Institute der TU Graz eingebunden. Der Versuch die Donau Universität Krems einzubinden schlug aufgrund der Nichtgenehmigung der beantragten Finanzierung eines Projektes fehl und blieb auf die Teilnahme an einem Expert Meeting beschränkt. Zusätzlich wurden die Planer der Demoprojekte (12 verschiedene Architektur und Planungsbüros) involviert. Bei 31 Teilnahmen österreichischer Experten an den Task 37 Expert Meetings wurden von österreichischer Seite 16 Vorträge (Präsentationen) zu verschiedensten Themen gehalten, wobei das dritte Task Expert Meeting im Oktober 2008, organisiert von Team Austria, in Wien abgehalten und durch eine eintägige Exkursion (Technical Tour) ergänzt wurde, bei der unter anderem, durch das im Rahmen der Programmlinie Haus der Zukunft geförderte Projekt „Tschechenring“ (Fig. 4, Pkt. 3) geführt wurde.



Fig. 4: im Rahmen der Exkursion besichtigte Sanierungsprojekte

- 1) Generalsanierung eines klassizistischen Gebäudes in der Maria Treu Gasse (Wien)  
Präsentation: POS Architekten ZT KEG
- 2) Renovierung eines Gebäudes im historischen Ambiente in der Lange Gasse (Wien)  
Präsentation: Architekturbüro Reinberg
- 3) Renovierung der Arbeitersiedlung Tschechenring (Niederösterreich)  
Präsentation: Wohnbaugenossenschaft WIEN SÜD
- 4) Generalsanierung von drei Wohngebäuden in der Oberen Amtshausgasse (Wien)  
Präsentation: Ulreich Baurträger GmbH

Die Präsentation des Task 37 im Rahmen eines Meetings der Österreich-Tschechischen Energiepartnerschaft, die Teilnahme und Präsentation bei HDZ Vernetzungstreffen, die Einbindung einzelner Fragestellungen in die Lehrveranstaltung Solares Bauen und die Durchführung von zwei Diplomarbeiten runden das Bild der Vernetzung ab. Weiters werden die eingebrachten Arbeiten durch die Subtaskleiter in Präsentationen wichtiger Konferenzen weitergetragen und somit bekanntgemacht (Beispiel: Robert Hastings bei der EURSUN 2008).

### **Bilanz Dissemination der HDZ Ergebnisse**

Die Einbindung der Programmlinie „Haus der Zukunft“ in die Arbeit des TASK 37 wurde auf drei verschiedenen Ebenen vorangetrieben.

- Erstens wurde die Programmlinie „Haus der Zukunft“ im Rahmen des dritten Expert Meetings durch einen Vortrag von Generalsekretär der ÖGUT Dr. Herbert Greisberger der internationalen Expertengruppe nähergebracht. Zwei weitere diesbezügliche Präsentationen wurden von Claudia Dankl (HDZ verantwortliche Mitarbeiterin der ÖGUT) im Rahmen einer dem TASK 37 assoziierten Konferenz bzw. dem 4<sup>th</sup> Expert Meeting in Haarlem gehalten.
- Zweitens wurde in den österreichischen Beiträgen zu den Task Ergebnissen intensiv auf die im Rahmen von HDZ veröffentlichten Forschungsberichte zurückgegriffen. Die Ergebnisse folgender HDZ Projekte wurden einbezogen:

#### **einbezogene HDZ Projekte im Bereich „participation“**

---

- Experiences and attitudes of users as a basis for the development of sustainable housing concepts with high social acceptance'
- Sanierung PRO!
- Cooperative Refurbishment
- Facilitated decision-making procedures for sustainable renovation of residential properties – Participation in the renovation process' (PARTI-SAN)
- Inhabitants-friendly passiv house renovation in Klosterneuburg / Kierling

#### **einbezogene HDZ Projekte im Bereich „ventilation“**

---

- Evaluation of mechanical class room ventilation systems in Austria and generation of a planning guideline
- Training Offensive: Comfort Ventilation
- Technical status of ventilation systems for buildings

#### **einbezogene HDZ Projekte im Bereich „insulation“**

---

- Sprayed-on and Plaster-covered Cellulose-insulation without vapour barrier
- Research work on outside sprayed-on cellulose insulation covered with plastering

### **einbezogene HDZ Projekte im Bereich „solar energy concepts“**

---

- Demonstration objects accompanied by measurement techniques for optimised and standardised solar systems in the construction of residential buildings for several families (OPTISOL)
- Heat supply of development areas through supplementary solar supported near heat nets (MOSOL-NET)
- IEA SHC 42, Task Solar Thermal Plants with Advance Thermal Storage Technologies for Low Energy Buildings
- Facade Integrated Solar Collectors
- MODESTORE – Modular High Energy Density Sorption Heat Storage
- Regional concepts of CO<sub>2</sub>-neutral heat demand and refrigeration load covering
- Solar Assisted Heating Networks
- wohnsolar!, solar thermal systems for multiple-family houses

Drittens sind fünf der zwölf ausgesuchten hochwertigen Sanierungsvorhaben, für die Broschüren angefertigt wurden, Demonstrationsprojekte aus der Programmlinie Haus der Zukunft:

### **einbezogene HDZ “demonstration buildings”**

---

112	Housing in Purkersdorf, AT
114	Apartment building in Kierling, AT
120	5-storey apartment house in Linz - Makartstraße - AT
122	Single - family house in Pettenbach - AT
154	Old people's home in Landeck - AT

---

### **Bilanz der inhaltlichen Arbeit**

Der Fokus der im Team Austria verfolgten Bemühungen lag in der Analyse von durchgeführten Sanierungen auf Gebäudeebene (siehe Kapitel: Analyse herausragender Projekte) und der Bearbeitung einzelner technischer Fragestellungen auf der Bauteil- bzw. gebäudetechnischen Ebene (siehe Kapitel: Konzept- und Komponentenanalyse). Obwohl die Expertise des österreichischen Teams eine Konzentration auf architektonische und technische Aspekte bedingte wurden dennoch die Aspekte des Marketings (siehe Kapitel: Marketing und Kommunikation) und die Aspekte einer generellen Nachhaltigkeitsbewertung (siehe Kapitel: Bewertung der Umweltwirkung) nicht außer acht gelassen. Neben zahlreicher Teilnahmen österreichischer Experten in den entsprechenden Subtask-Meetings wurden eine ganze Reihe verschiedener Aspekte aus diesen beiden Subtasks in die Queranalyse der österreichischen Demoprojekte übernommen (siehe: [17\\_Task37\\_Queranalyse](#))

### **3 Die Arbeit in den Subtasks**

SUBTASK A  
Marketing and Communication Strategies

SUBTASK B  
Advanced Projects Analyses

SUBTASK C  
Analysis and Concepts

SUBTASK D  
Environmental Impact Assessment

### 3.1 Subtask A - Marketing und Kommunikation

In Subtask A ist eine Veröffentlichung mit dem Titel "From introduction to volume market, Market development of high-ambition renovation" in Arbeit. Der Fokus der angestellten Analysen liegt dabei in der Beantwortung der Frage wie aus derzeit vereinzelt auftretenden hochwertigen Sanierungsprojekten die Schwelle zu einem diesbezüglichen Massenmarkt durchbrochen werden könnte, wobei Aspekte wie z.B. Marketing, Meinungsbildung, Förderwesen, Kreditwesen untersucht wurden. Der entsprechende Bericht wird ab Herbst 2010 unter folgender Adresse verfügbar sein: <http://www.iea-shc.org/task37/index.html>

Als Grundlagen dieser Analysen dienten einerseits die in den durchgeführten Meetings gehaltenen Präsentationen und Diskussionen der internationalen Expertengruppe und andererseits von den einzelnen Ländern angefertigte Analysen in Bezug auf Gebäudebestand, Sanierungsquoten, Rahmenbedingungen und anderer für das Verständnis des Sanierungsmarktes relevanten Informationen.

### 3.2 Analyse des österreichischen Gebäudebestandes

Auf Grundlage der oben beschriebenen Ausgangslage entstand im Rahmen des österreichischen Beitrages eine Aufarbeitung der nationalen Gegebenheiten, welche im Rahmen einiger Meetings in die internationale Expertengruppe eingebracht wurden. In Bezug auf den österreichischen Gebäudebestand entstand zudem ein eigenständiges Dokument. Fig. 5 zeigt das Cover des Dokuments, welches im „Anhang – Beiträge zu Subtask A“ vollinhaltlich dargestellt ist.

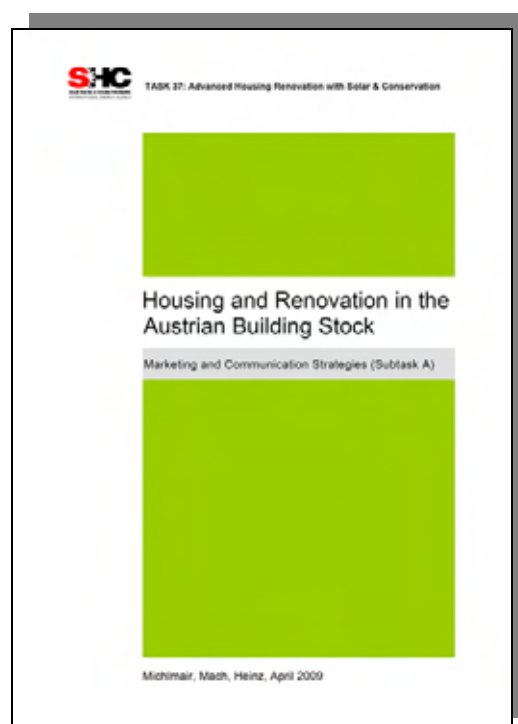

Fig. 5: Cover des Dokumentes zum österreichischen Gebäudebestand

Im Rahmen dieser Arbeiten wurde ein Überblick über den österreichischen Gebäudebestand und über aktuelle Entwicklungen am Bausektor erstellt und Schlussfolgerungen und Empfehlungen formuliert. Die folgenden Absätze zeigen eine diesbezügliche kurze Zusammenfassung.

## Zusammenfassung Status Quo

Der österreichische Gebäudebestand beinhaltet im Jahr 2001 ca. 2,05 Millionen Gebäude mit ca. 3,86 Millionen Wohnungen auf einer Gesamtnutzfläche von ca. 299 Millionen Quadratmetern. Ordnet man die einzelnen Gebäude nach ihrer hauptsächlichen Nutzung, so zeigt sich eine deutliche Dominanz von Gebäuden mit 1 oder 2 Wohnungen (Ein- und Zweifamilienhäuser) mit ca. 76 %. 86,4 % der Gebäude sind dabei in Privatbesitz. Im Laufe der letzten Jahrzehnte stieg die im Mittel pro Person zur Verfügung stehende Wohnnutzfläche und die Anzahl der Wohnungen pro Person stetig an. Zu Beginn des 21. Jahrhunderts stehen in Österreich jedem Einwohner laut der letzten Gebäude- und Wohnungszählung im Jahr 2001, im Mittel, 38,2 m<sup>2</sup> Wohnnutzfläche zur Verfügung. Bis ins Jahr 2007 stieg diese Kenngröße auf 42,3 m<sup>2</sup> pro Person an.

Die Entwicklung des Heizwärmebedarfes im österreichischen Gebäudebestand verlief ähnlich wie in vielen anderen mitteleuropäischen Ländern. Je nach Gebäudetyp und Gebäudealter kann mit einer Spannweite des Heizwärmebedarfes von 230 kWh/m<sup>2</sup>a (bezogen auf BGF) für Gebäude, errichtet kurz nach dem zweiten Weltkrieg, bis zu Gebäuden mit einem Heizwärmebedarf von 40 kWh/m<sup>2</sup>a (bezogen auf BGF), für den derzeitigen Geschoßwohnbau, gerechnet werden. Der größte Anteil davon wird mit Zentralheizungen auf Basis der Energieträger Erdgas und Erdöl beheizt.

Seit dem Jahr 1990 sind die jährlichen CO<sub>2</sub>-Emissionen konstant gestiegen und haben im Jahr 2003 die 23 Millionen Tonnen Grenze überschritten. Die durch die Beheizung der Gebäude verursachten Emissionen blieben in diesem Zeitraum, mehr oder weniger konstant. Obwohl verschiedenste Maßnahmen gestartet wurden, ist davon auszugehen, dass die im Kyoto-Protokoll festgelegte Reduktion bei weitem nicht erreicht werden kann. Eine substantielle Reduktion des Energiebedarfes kann in absehbarer Zeit nicht über den Neubau, sondern nur auf Grundlage einer intensivierten Renovierungstätigkeit erzielt werden. Die Vereinfachung durch die Harmonisierungen der Bauordnungen, die Einführung des Gebäudeausweises sowie diverse Fördermodelle wirken sich positiv auf die Renovierungsrate aus. Hingegen bewirken die gesetzlichen Rahmenbedingungen, dass eine Vielzahl möglicher Sanierungsvorhaben an der fehlenden Zustimmung der Bewohner bzw. Besitzer scheitern.

## Schlussfolgerungen und Empfehlungen

Unter Betrachtung der Entwicklung, der derzeitigen Situation und der gegenwärtigen Entwicklungstendenzen des österreichischen Gebäudebestandes sollten die drei folgenden, jeweils auf einer Betrachtungsebene angesiedelten, Ansätze zu einer Reduktion des Energiebedarfes vorrangig betrachtet werden. Eine Analyse auf „Gebäudeebene“ zeigt, dass die im Zeitraum 1945 bis 1961 errichteten Wohngebäude, begründet auf ihrem enormen Heizwärmebedarf, ein besonders attraktives Einsparungspotential bieten. Die Betrachtung auf „städtebaulicher Ebene“ zeigt, dass die hohe Anzahl der Einfamilienhäuser einen enormen CO<sub>2</sub> Ausstoß zur Folge hat. Die in Einfamilienhausbebauungen systemimmanente niedere städtebauliche Dichte verursacht zudem, neben dem hohen Heizwärmebedarf, enorme Folgewirkungen. Die Bereitstellung der benötigten baulichen Infrastruktur und die Bereitstellung der Individualmobilität sind mit hohen Kosten und einem hohen CO<sub>2</sub>-Ausstoß verknüpft. Auf der „rechtlichen Ebene“ finden sich zudem im Mietrechtsgesetz, im Wohnungsgemeinnützigkeitsgesetz und im Wohnungseigentumsgesetz grundlegende Stolpersteine auf dem Weg zu hochwertigen thermischen Sanierungen. Eine diesbezügliche Anpassung der rechtlichen Grundlage hätte große Auswirkungen auf die Sanierungstätigkeit in Österreich.

## Filme



Im Rahmen der Task 37 Bearbeitung entstanden themenspezifische, von Norwegen finanzierte, Kurzfilme (Housing Renovations Film Clips) in englischer und deutscher Sprache. Unter folgender Adresse können die unten angeführten Kurzfilme kostenlos heruntergeladen werden:

[www.lavenergiboliger.tv/filmengelsk.html](http://www.lavenergiboliger.tv/filmengelsk.html)

Die Vorteile beim Niedrigenergiehaus	4 Minuten
Vom Wohnblock zum Niedrigenergiebau, Nürnberg	17 Minuten
Baugenossenschaft für Passivhäuser, Schweden	16 Minuten
Mit Hilfe der Gemeinde, Norwegen	12 Minuten



### 3.3 Subtask B - Analyse herausragender Projekte

In Subtask B wurden aus zehn beteiligten Ländern Beispiele hochwertiger Wohnbausanierungen untersucht und in der Form von genormten Broschüren aufbereitet (in Summe 60 Sanierungen). Die Projektbeispiele zeigen verschiedenste Ausformungen von Wohnbauten. Neben Geschößwohnbauten, Reihenhäusern, Einfamilienhäusern wurden auch historische Gebäude betrachtet.

Im Rahmen des österreichischen Beitrages wurden die entsprechenden Daten für zwölf österreichische Wohnbau-Sanierungsvorhaben aufbereitet. Die Daten flossen einerseits in einen Analysebericht, bezeichnet als "Lessons Learned Summary" (Autor: Subtaskleiter Robert Hastings- siehe Fig. 6), und andererseits wurden die Sanierungsvorhaben in einzelnen Broschüren beschrieben. Der Analysebericht, ist unter der folgenden Internetadresse zugänglich:

<http://www.iea-shc.org/publications/task.aspx?Task=37>

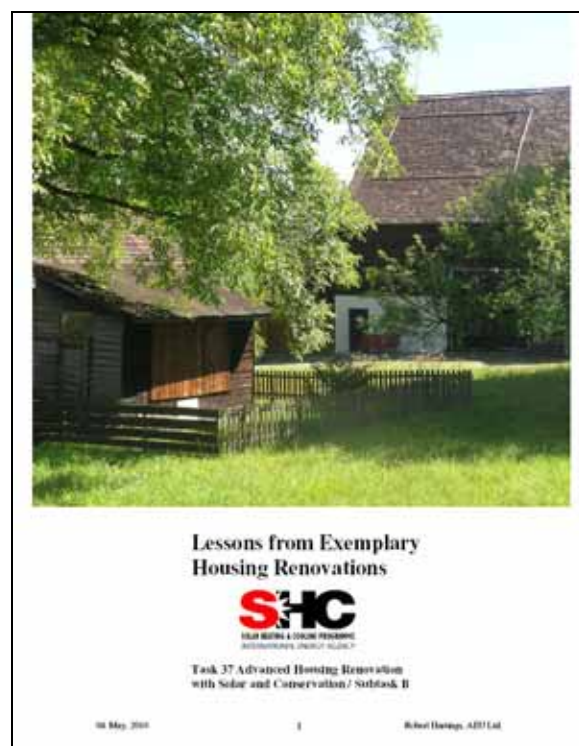

Fig. 6: Queranalyse der sechzig untersuchten Sanierungsvorhaben (Autor: Robert Hastings)

In der Folge werden die zentralen Aussagen der obigen Publikation angeführt:

Sanierungs-  
maßnahmen

Die Auswertung der Demonstrationsobjekte zeigt erwartungsgemäß, dass ein sehr hoher Prozentsatz der Sanierungsvorhaben eine Verbesserung der Gebäudehüllen durch Außendämmungen beinhalteten, nur sieben der sechzig Projekte griffen auf Innendämmung zurück. Dass zweiundvierzig der sechzig Projekte den Sanierungsprozess nutzen um ein Überdenken und Adaptieren des Grundrisses durchzuführen ist als positiver Aspekt zu vermerken. Die in den 1980ern des letzten Jahrhunderts aufgekommenen und besonders populären „Wintergärten“ wurden hingegen nur in vier von sechzig Sanierungen umgesetzt.

Hingegen kamen in einundfünfzig der sechzig Projekte Lüftungsanlagen, die zumindest irgendeine Form der Wärmerückgewinnung ermöglichen, zum Einsatz. Die Beispiele zeigen zudem eine hohe Ambition in Bezug auf Verwendung erneuerbarer Energieträger. Vierunddreißig der sechzig Sanierungsvorhaben inkludieren thermische oder photovoltaische aktive Solarsysteme oder beides.

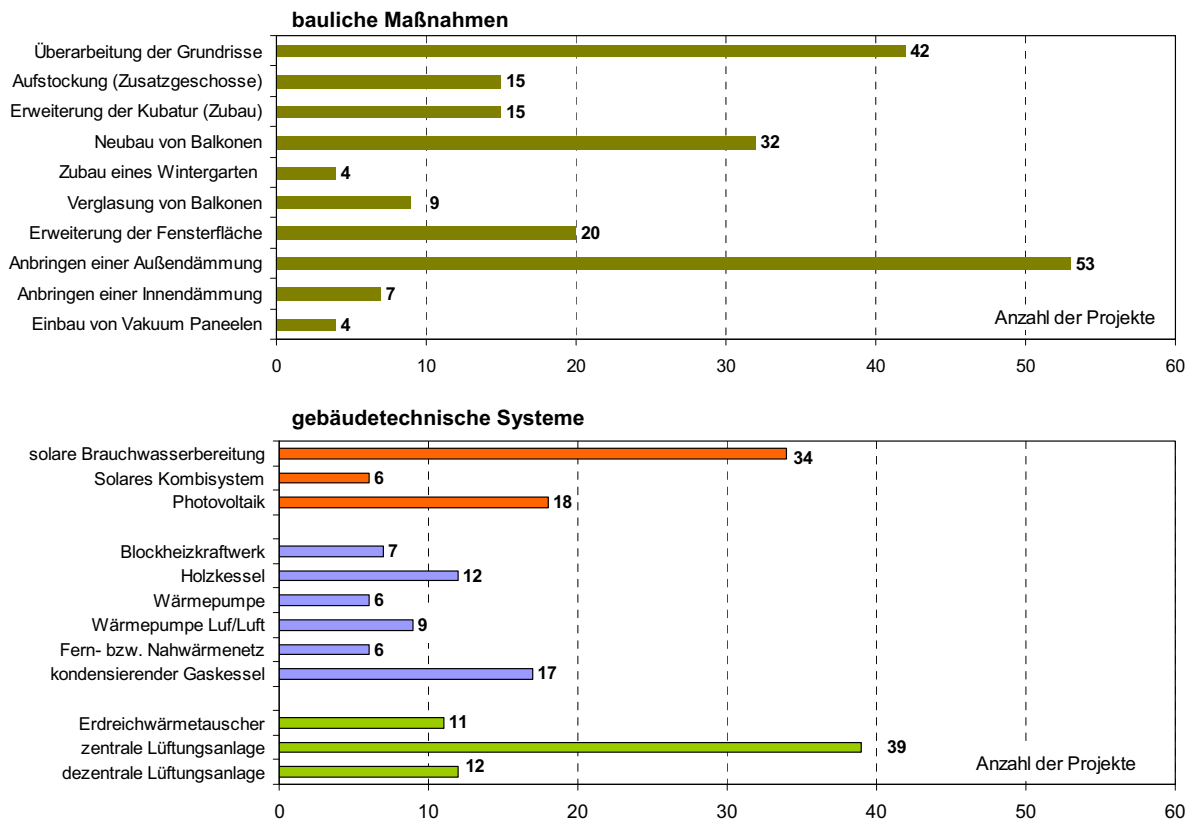

Fig. 7: Auswertung der ausgewählten Demonstrationsgebäude nach baulichen Sanierungsmaßnahmen und nach Verwendung gebäudetechnischer Systeme (Datenquelle: Robert Hastings)

Wärmeschutz der Gebäudehülle

Die Auswertungen zeigen, dass in den Gebäudehüllen eine drastische Verbesserung des Wärmeschutzes erreicht werden konnte. Eine deutliche Verringerung des über alle Sanierungsobjekte gemittelten U-Wertes konnte für alle Hüllflächenkomponenten (oberste Geschossdecke, Wand, etc.) verwirklicht werden (Fig. 8).

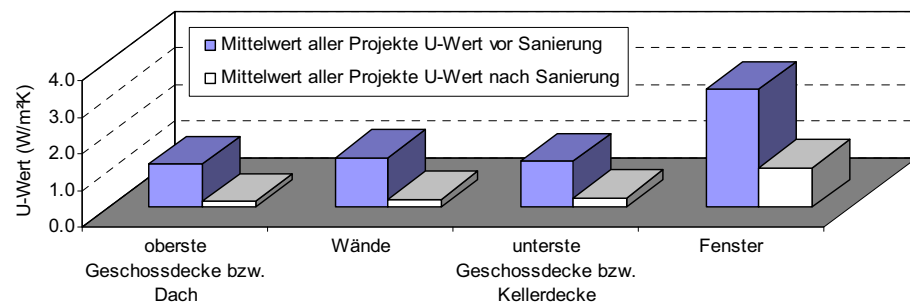

Fig. 8: Auswertung des Wärmeschutzes der Gebäudehüllen (Datenquelle: Robert Hastings)

## Energieeinsparung

Die Auswertungen zeigen, dass in allen Sanierungsvorhaben enorme Einsparungen auf Primärenergieebene möglich gemacht werden konnten. Die über alle Projekte gemittelte Einsparung an Primärenergie für Heizen und Brauchwasserbereitung liegt bei 83%, wobei einzelne Projekte (zumindest im rechnerischen Vergleich) bis zu 90% Einsparung erzielen konnten (Fig. 9).

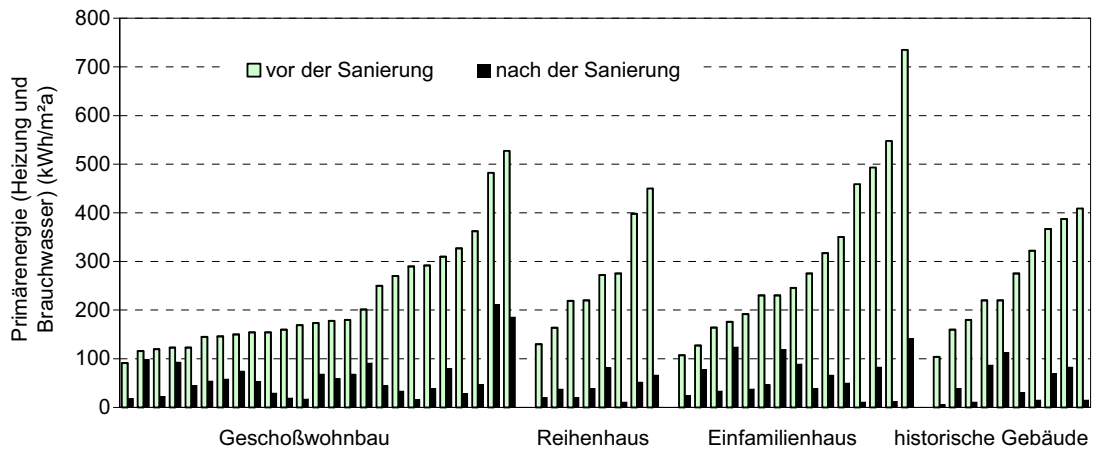

Fig. 9: Primärenergiebedarf für Heizung und Brauchwasser „vor der Sanierung“ im Vergleich zu „nach der Sanierung“ (Datenquelle: Robert Hastings)

### 3.4 Kurzbeschreibungen der zwölf eingebrachten Sanierungsprojekte

Die folgenden Kapitel bieten eine Kurzbeschreibungen der zwölf von österreichischer Seite eingebrachten Sanierungsprojekte; die Vollversionen sind in den jeweiligen Broschüren sowie im Anhang 2 zu finden.

## Schmetterlingshaus in Mautern



Broschüre 110: Enhancement in Mautern

### Allgemeine Informationen

Gebäudetyp: Zweifamilienhaus freistehend  
Lage: städtisches Gefüge  
Standort: 3512 Mautern, Niederösterreich  
Errichtungsjahr: Bestand 50er Jahre  
Baubeginn bzw. Fertigstellung: Februar 2004 | Juli 2004  
Nutzfläche alt/neu: 115 m<sup>2</sup> | 248 m<sup>2</sup>  
Wohneinheiten alt/neu: 1 WE | 2 WE  
Konstruktionsweise alt/neu: Betonhohlstein | Holzriegelkonstruktion  
Bauherr: Familie T. | Privat  
Planung: Architekt Dipl. Ing. (FH) Thomas Abendroth

### Sanierungsmaßnahmen

Abbruch des Satteldaches  
Aufstockung eines Geschosses  
Außenliegende Wärmedämmung  
Anbau eines Treppenhauses  
Neue Fenster mit 3 - Scheiben Verglasung im Ausbau  
Einbau einer kontrollierten Wohnraumlüftung im Ausbau  
Neue Öffnungen im Bestand

### Weiterführende Informationen

→ Broschüre im „Anhang – Beiträge zu Subtask B“ (englisch)  
→ „Motiv- und Ergebnisanalyse der Umsetzung von 12 nachhaltigen Sanierungen im österreichischen Wohnbau“, als Fallbeispiel:  
F01 Schmetterlingshaus in Mautern

## Villa in Purkersdorf



Broschüre 112: Housing in Purkersdorf

### Allgemeine Informationen

Gebäudetyp: Gründerzeit Villa | Mehrfamilienhaus freistehend  
Lage: städtisches Gefüge  
Standort: 3002 Purkersdorf, Niederösterreich  
Errichtungsjahr Bestand: Spätes 19. Jahrhundert  
Baubeginn bzw. Fertigstellung: 2007 | 2008  
Nutzfläche alt/neu: 372 m<sup>2</sup> | 587 m<sup>2</sup>  
Wohneinheiten alt/neu: 1 WE | 4 WE  
Konstruktionsweise alt/neu: Ziegelbau | Dachstuhl Brettschichtholz  
Bauherr: Aufbauwerk der Öster. Jungarbeiterbewegung GmbH  
Planung: Architekturbüro Reinberg ZT GmbH

### Sanierungsmaßnahmen

Sanierungsmaßnahmen  
Erneuerung der Dachkonstruktion  
Wärmedämmverbundsystem  
Sanierung der Kastenfenster  
Wiederherstellung der Stuckfassade  
Erneuerung der Haustechnik  
Kontrollierte Wohnraumlüftung

### Weiterführende Informationen

→ Broschüre im „Anhang – Beiträge zu Subtask B“ (englisch)  
→ Motiv- und Ergebnisanalyse der Umsetzung von 12 nachhaltigen Sanierungen im österreichischen Wohnbau, als Fallbeispiel:  
F03 Villa in Purkersdorf



## Apartmenthaus in Kierling



Broschüre 120: Apartment building in Kierling

### Allgemeine Informationen

Gebäudetyp: Mehrfamilienhaus freistehend  
Lage: städtisches Gefüge  
Standort: 3400 Klosterneuburg, Niederösterreich  
Errichtungsjahr: Bestand 1977-1979  
Baubeginn bzw. Fertigstellung: 2010 | 2011  
Nutzfläche alt/neu: 2.039 m<sup>2</sup> | 2.847 m<sup>2</sup>  
Wohneinheiten alt/neu: 24 WE | 30 WE  
Konstruktionsweise alt/neu: Holzspanbeton | Holzkonstruktion (Brettschichtholz)  
Bauherr: BUWOG, Bauen und Wohnen GmbH  
Planung: Architekturbüro Reinberg ZT GmbH

### Sanierungsmaßnahmen

Aufbringen einer Außenwanddämmung  
Dämmung der Kellerdecke  
Dachaufstockung, neue Liftkonstruktion als Vorbau  
Schließung der Loggien  
Neue Fenster mit dreifach Wärmeschutzverglasung  
Erneuerung der Haustechnik, kontrollierte Wohnraumlüftung  
Nachverdichtung des Geschoßbaues

### Weiterführende Informationen

→ Broschüre im „Anhang – Beiträge zu Subtask B“ (englisch)  
→ Motiv- und Ergebnisanalyse der Umsetzung von 12 nachhaltigen Sanierungen im österreichischen Wohnbau, als Fallbeispiel:  
F02 Apartmenthaus in Kierling

## Erweitertes Einfamilienhaus in St. Valentin



Broschüre 116: Enhancement house in St. Valentin

### Allgemeine Informationen

Gebäudetyp: Zweifamilienhaus freistehend

Lage: Land

Standort: St. Valentin, Oberösterreich

Errichtungsjahr Bestand: 1982

Baubeginn bzw. Fertigstellung: 2005 | 2006

Nutzfläche alt/neu: 129 m<sup>2</sup> | 256 m<sup>2</sup>

Wohneinheiten alt/neu 1 WE | 2 WE

Konstruktionsweise alt/neu: Leichtbetonhohlstein | Holzriegelkonstruktion

Bauherr: Familie W. und Familie Z. | Privat

Planung: Thomas Wimmer MAS, Jordan Solar

### Sanierungsmaßnahmen

Außendämmung der Gebäudehülle

Einbau passivhaustauglicher Fenster im Obergeschoss

Dachaufstockung (Nachverdichtung)

kontrollierte Wohnraumlüftung mit WRG

neue Sanitärinstallationen

Zentralstaubsauger

Einbau einer Luft/Luft Wärmepumpe

### Weiterführende Informationen

→ Broschüre im „Anhang – Beiträge zu Subtask B“ (englisch)

## Wohnblock in Linz



Broschüre 120: 5-storey apartment house in Linz

### Allgemeine Informationen

Gebäudetyp Mehrfamilienhaus: Blockbebauung

Lage: Stadt

Standort: 4020 Linz, Oberösterreich

Errichtungsjahr: Bestand 1957/58

Baubeginn bzw. Fertigstellung: 2005 | 2006

Nutzfläche alt/neu: 2.811 m<sup>2</sup> | 3.165 m<sup>2</sup>

Wohneinheiten alt/neu: 50 WE | 50 WE

Konstruktionsweise alt/neu: Schlackenbeton mit vorgesetzter GAP Solarfassade

Bauherr: Gemeinnützige Industrie-Wohnungs-AG GIWOG

Planung: Architekturbüro ARCH+MORE ZT GmbH

### Sanierungsmaßnahmen

Neue Fassadenhülle mittels GAP-Solarfassade

Dämmung der obersten Geschoßdecke und der Kellerdecke, neues Dach

Neue Fenster mit 3 - Scheiben Verglasung

Balkonvergrößerung

thermische Einbindung der Balkone, Stiegenhaus und Lifte in die Fassade

Einbau einer kontrollierten Einzelwohnraumlüftung

### Weiterführende Informationen

→ Broschüre im „Anhang – Beiträge zu Subtask B“ (englisch)

→ Motiv- und Ergebnisanalyse der Umsetzung von 12 nachhaltigen Sanierungen im österreichischen Wohnbau, als Fallbeispiel:

F04 Wohnblock in Linz



## Passivhaus in Pettenbach



Broschüre 122: Single-family house in Pettenbach

### Allgemeine Informationen

Gebäudetyp: Einfamilienhaus freistehend

Lage: Land

Standort: 4643 Pettenbach, Oberösterreich

Errichtungsjahr: Bestand 1962

Baubeginn bzw. Fertigstellung: Juli 2004 | September 2005

Nutzfläche alt/neu: 81 m<sup>2</sup> | 195 m<sup>2</sup>

Wohneinheiten alt/neu: 1 WE | 1 WE

Konstruktionsweise alt/neu: Holzspanbeton | Holzriegelkonstruktion

Bauherr: Familie S. | Privat

Planung: Lang Consulting

### Sanierungsmaßnahmen

Abbruch Satteldach

Aufstockung eines Geschoßes mit neuer Dachkonstruktion

neue Grundrissaufteilung (Durchbrüche)

Außendämmung durch Fertigteile

Dämmung der Kellerdecke

neue Fenster mit 3 - Scheiben Verglasung

Vergrößerung der Fensteröffnungen

Erneuerung der Haustechnik und Einbau einer kontrollierten Wohnraumlüftung

### Weiterführende Informationen

→ Broschüre im „Anhang – Beiträge zu Subtask B“ (englisch)

→ Motiv- und Ergebnisanalyse der Umsetzung von 12 nachhaltigen Sanierungen im österreichischen Wohnbau, als Fallbeispiel:

F05 Passivhaus in Pettenbach

## Bürgerhaus in Irdning



Broschüre 130: Historic building in Irdning

### Allgemeine Informationen

Gebäudetyp: Mehrfamilienhaus

Lage: städtisches Gefüge

Standort: 8952 Irdning, Steiermark

Errichtungsjahr: Bestand 1567

Baubeginn bzw. Fertigstellung: Dezember 2004 / Frühjahr 2006

Nutzfläche alt/neu: 415 m<sup>2</sup> | 516 m<sup>2</sup>

Wohneinheiten alt/neu: 1 WE | 4 WE plus Geschäftslokale im EG

Konstruktionsweise alt/neu: Ziegelbau | Ziegelbau gedämmt

Eigentümer: Familie H. | Privat

Planung: Hegedys & Ull Gebäude und Naturraum Projektierung GmbH

### Sanierungsmaßnahmen

Aufbringen einer Außenwanddämmung

Dämmung der Kellerdecke

Dachdämmung

Erhaltung der alten Gewölbe und Strukturen

Überdachung und Schließung des Hofes

Sanierung der Kastenfenster

Erneuerung der Haustechnik

kontrollierte Wohnraumlüftung

### Weiterführende Informationen

→ Broschüre im „Anhang – Beiträge zu Subtask B“ (englisch)

→ Motiv- und Ergebnisanalyse der Umsetzung von 12 nachhaltigen Sanierungen im österreichischen Wohnbau, als Fallbeispiel:

F08 Bürgerhaus in Irdning

## Aufstockung in St. Martin



Broschüre 140: Single-family house in St. Martin

### Allgemeine Informationen

Gebäudetyp: Zweifamilienhaus freistehend

Lage: Land

Standort: St. Martin am Tennengebirge/Lammertal, Salzburg

Errichtungsjahr: Bestand 1973

Baubeginn bzw. Fertigstellung: 2005 | August 2007

Nutzfläche alt/neu: 118 m<sup>2</sup> | 220 m<sup>2</sup>

Wohneinheiten alt/neu: 1 WE | 2 WE

Konstruktionsweise alt/neu: Betonhohlstein | Holzriegelkonstruktion

Bauherr: Familie S. und H. | Privat

Planung: Grundstein Architektur, Architektin Dipl. Ing. Irene Prieler

### Sanierungsmaßnahmen

Abbruch von Satteldach und Zwischendecke

Aufstockung eines Geschoßes (neue Dachkonstruktion)

neue Grundrissaufteilung

Außenliegende Wärmedämmung

Anbau eines Essraumes, Treppenhauses

Neue Balkonkonstruktion

Erneuerung der Haustechnik, kontrollierte

Wohnraumlüftung

### Weiterführende Informationen

→ Broschüre im „Anhang – Beiträge zu Subtask B“ (englisch)

→ Motiv- und Ergebnisanalyse der Umsetzung von 12 nachhaltigen Sanierungen im österreichischen Wohnbau, als Fallbeispiel:

F07 Aufstockung in St. Martin

## New Faced Haus in Kufstein



Broschüre 150: Single-family house in Kufstein

### Allgemeine Informationen

Gebäudetyp: Einfamilienhaus freistehend

Lage: städtisches Gefüge

Standort: 6330 Kufstein, Tirol

Errichtungsjahr: Bestand 1981

Baubeginn bzw. Fertigstellung: Juni 2004 | November 2004

Nutzfläche alt/neu: 169 m<sup>2</sup> | 208 m<sup>2</sup>

Wohneinheiten alt/neu: 1 WE | 1 WE

Konstruktionsweise alt/neu: Ziegelbau | Ziegel, vorgesetzte Holzkonstruktion

Bauherr: Familie K. | Privat

Planung: Robert Pfurtscheller

### Sanierungsmaßnahmen

neue Fassadenhülle

Vergrößerung der Grundrissstruktur

neue Fenster mit 3 - Scheiben Verglasung

außenliegende Wärmedämmung

Dämmung der Dachkonstruktion

### Weiterführende Informationen

→ Broschüre im „Anhang – Beiträge zu Subtask B“ (englisch)

→ Motiv- und Ergebnisanalyse der Umsetzung von 12 nachhaltigen Sanierungen im österreichischen Wohnbau, als Fallbeispiel:

F06 New Faced Haus in Kufstein



## Haus im Haus in Innsbruck



Broschüre 1520: Attic conversion in Innsbruck

### Allgemeine Informationen

Gebäudetyp: Dachgeschoßausbau Blockbebauung

Lage: Stadt

Standort: 6020 Innsbruck, Tirol

Errichtungsjahr: Bestand 1982

Baubeginn bzw. Fertigstellung: 2005 | 2007

Nutzfläche alt/neu: 131 m<sup>2</sup> | 269 m<sup>2</sup>

Wohneinheiten alt/neu: 1 WE | 1 WE

Konstruktionsweise alt/neu: Ziegelbau | Holzkonstruktion Brettschichtholz

Bauherr: Herr H. | Privat

Planung: Architekt Daniel Fügenschuh

### Sanierungsmaßnahmen

Abbruch des Daches, von Zwischenwänden,

Zwischendecke und Kamin

neue Dachkonstruktion

neue Grundrissaufteilung (Verbindung der Gebäudeebenen)

neue Fenster mit zweifach Wärmeschutzverglasung

Erneuerung der Haustechnik

### Weiterführende Informationen

→ Broschüre im „Anhang – Beiträge zu Subtask B“ (englisch)

→ Motiv- und Ergebnisanalyse der Umsetzung von 12 nachhaltigen Sanierungen im österreichischen Wohnbau, als Fallbeispiel:

F10 Haus im Haus in Innsbruck

## Altenheim in Landeck



Broschüre 154: Old people's home in Landeck

### Allgemeine Informationen

Gebäudetyp: Terrassenhaus mit Innengängerschließung, freistehend

Lage: städtisches Gefüge

Standort: 6500 Landeck, Tirol

Errichtungsjahr: Bestand 1976

Baubeginn bzw. Fertigstellung: Februar 2004 | Juli 2007

Nutzfläche alt/neu: 5.665 m<sup>2</sup> | 6.629 m<sup>2</sup>

Wohneinheiten alt/neu: 109 WE | 89 WE

Konstruktionsweise alt/neu: Sichtbeton | Holzrahmen Fertigteile

Bauherr: Stadt Landeck | öffentlich

Planung: Gharakhanzadeh & Sandbichler Architekten ZT GmbH

### Sanierungsmaßnahmen

Dämmung der Dachkonstruktion

Verwendung von Holzbau – Fertigteil - Fassadenelemente

Teilerneuerung des Grundrisses

neue Fenster mit zweifach Isolierverglasung

### Weiterführende Informationen

→ Broschüre im „Anhang – Beiträge zu Subtask B“ (englisch)

→ Motiv- und Ergebnisanalyse der Umsetzung von 12 nachhaltigen Sanierungen im österreichischen Wohnbau, als Fallbeispiel:

F11 Altenheim in Landeck

## Wohnsiedlung in Dornbirn



Broschüre 160: Apartmentbuildings in Dornbirn

### Allgemeine Informationen

Gebäudetyp: Mehrfamilienhäuser freistehend

Lage: städtisches Gefüge

Standort: 6850 Dornbirn, Vorarlberg

Errichtungsjahr: Bestand 1980

Baubeginn bzw. Fertigstellung: 2008 | 2009

Nutzfläche alt/neu: 4460 m<sup>2</sup> | 4460 m<sup>2</sup>

Wohneinheiten alt/neu: 54 WE | 54 WE

Konstruktionsweise alt/neu: Ziegelbau | Massivbau mit WDVS

Bauherr VOGEWOSI – Vorarlberger gemeinnützige

Wohnungsbau- und Siedlungsgesellschaft mbH

Planung Architekt Dipl. Ing. Helmut Kuess

### Sanierungsmaßnahmen

Aufbringen einer Außenwanddämmung

Dämmung der Kellerdecke

Dämmung obersten Geschoßdecke

Umwandlung der Balkone zu Wintergärten

neue Fenster mit dreifach Wärmeschutzverglasung

kontrollierte Wohnraumlüftung

### Weiterführende Informationen

→ Broschüre im „Anhang – Beiträge zu Subtask B“ (englisch)

→ Motiv- und Ergebnisanalyse der Umsetzung von 12 nachhaltigen Sanierungen im österreichischen Wohnbau, als Fallbeispiel:

F09 Wohnsiedlung in Dornbirn

### 3.5 Queranalyse der österreichischen Projekte

Zusätzlich zu den auf TASK-Ebene durchgeführten Analysen entstand im Rahmen von zwei an der TU Graz betreuten Diplomarbeiten eine detaillierte Queranalyse von elf der zwölf in den Task 37 eingebrachten österreichischen Demonstrationsgebäude. Fig. 10 zeigt das Cover der im Oktober 2009 abgeschlossenen Doppel-diplomarbeit.



Fig. 10: Cover der durchgeführten Diplomarbeiten zum Quervergleich der österr. Projekte

Grundlage der Auswahl der Demonstrationsgebäude war die Zuordnung zur Nutzungskategorie Wohnbau und eine überdurchschnittlich hohe Ambition durch Sanierungsmaßnahmen den Heizwärmebedarf drastisch zu senken. Außerdem wurde bei der Auswahl der österreichischen Beispiele auf eine gute Durchmischung von Standort (Fig. 11) und Einfamilienhaus bzw. Geschosswohnbau gelegt.



Fig. 11: Standorte und Bezeichnungen der untersuchten Sanierungsobjekte



In Anlehnung an das Dreieck der Nachhaltigkeit (Ökonomie, Ökologie, Soziales) wurde, ergänzt durch den Bereich Architektur, ein Satz an Vergleichskriterien erarbeitet und auf die Sanierungsobjekte angewendet. Der Erfüllungsgrad der einzelnen Kriterien in der Folge angeführten Kriterien wurde in einem Quervergleich dargestellt und analysiert.

<b>Architektur</b> .....	Kubatur Fassadenanschluss Nutzungsflexibilität Erweiterung Abbruch Architektonische Hülle
<b>Ökologie</b> .....	Energiehülle Kompaktheit Ausrichtung Verglasung Wärmeschutz Verglasung Nutzenergie Endenergie Primärenergie Heizsysteme Emissionen Herstellungsenergie
<b>Ökonomie</b> .....	Errichtungskosten Finanzierung
<b>Soziales</b> .....	Belegungsdichte Logistik

### Vergleich der Energiekennzahlen

Um eine stabile Vergleichsbasis zu erhalten wurden alle ausgewählten Gebäude in ihrem Zustand „vor“ der Sanierung und in ihrem Zustand „nach“ der Sanierung in gleicher Form rechnerisch bewertet. Als Bewertungsinstrument kamen die Rechenvorschriften gemäß dem österreichischen Energieausweis (Erstellung von Monatsbilanzen) zur Anwendung. Die Demonstrationsgebäude wurden entlang der Energiebereitstellungskette nach Heizwärmebedarf (Nutzenergieebene), Heizenergiebedarf (Endenergieebene) bewertet. Der Primärenergiebedarf für Heizung und Warmwasser und die CO<sub>2</sub>-Emissionen wurden einerseits mit den im TASK 37 verwendeten Konversionsfaktoren (Quelle: Gemis 2004) und andererseits nach den Konversionsfaktoren der EN 15603:2008 berechnet. Die Energiekennzahlen wurden in der Folge auf verschiedene Flächeneinheiten und Volumeneinheiten bezogen. Fig. 12 zeigt einen Auszug.

#### Legende:

BGF	Bruttogeschoßfläche (d.h. Außenabmessungen)
NGF	Nettogeschoßfläche (d.h. Innenabmessungen)
HWB	Heizwärmebedarf
EEB	Endenergiebedarf
PEB	Primärenergiebedarf
V <sub>netto</sub>	Nettovolumen (d.h. eingeschlossenes Luftvolumen)
V <sub>brutto</sub>	Bruttovolumen (d.h. Außenabmessungen)



Projekt	F01	F02	F03	F04	F05	F06	F07	F08	F09	F10	F11	F12
---------	-----	-----	-----	-----	-----	-----	-----	-----	-----	-----	-----	-----

## GEOMETRIE

BGF [m <sup>2</sup> ]	Bestand	143	2 476	520	3 696	119	245	153	603	1 091	164	6 525	146
	saniert	337	3 701	828	4 263	304	290	297	745	1 148	333	7 619	257
Volumen Brutto [m <sup>3</sup> ]	Bestand	458	7 704	2 157	10 727	376	722	486	1 876	3 192	716	21 347	485
	saniert	1 157	11 525	3 204	12 733	1 001	869	927	2 404	3 483	1 225	22 768	834
NGF [m <sup>2</sup> ]	Bestand	115	2 039	372	2 811	81	169	118	415	893	131	5 665	105
	saniert	248	2 847	587	3 165	195	208	220	509	893	263	6 629	189
Volumen Netto [m <sup>3</sup> ]	Bestand	300	5 260	1 228	7 308	205	430	295	988	2 214	470	14 169	288
	saniert	682	7 660	1 875	8 230	416	522	555	1 358	2 214	915	18 397	454

## NUTZENERGIE ABSOLUT

HWBref [kWh/a]	Bestand	47 522	194 942	93 855	433 508	43 859	22 591	35 224	120 240	86 276	31 541	387 520	63 039
	saniert	14 008	47 563	12 182	47 154	3 584	13 181	4 971	28 245	18 322	18 358	286 551	13 262
EEB [kWh/a]	Bestand	61 918	249 614	186 815	549 943	57 354	38 219	61 715	172 224	122 836	67 269	712 204	106 959
	saniert	31 120	275 604	63 014	123 172	13 232	32 470	15 954	53 979	61 028	36 489	627 653	14 322
PEB [kWh/a]	Bestand	70 526	224 630	212 794	441 751	65 383	43 084	70 249	194 437	158 971	76 601	803 678	1 188
	saniert	27 991	69 956	13 043	97 932	4 083	36 159	3 481	11 879	67 851	41 313	707 957	4 403

## NUTZENERGIE SPEZIFISCH

HWB/BGF [kWh/m <sup>2</sup> a]	Bestand	332	79	180	117	367	92	230	199	79	193	59	433
	saniert	42	13	15	11	12	46	17	38	16	55	38	52
HWB/Vbrutto [kWh/m <sup>2</sup> a]	Bestand	104	25	44	40	117	31	72	64	27	44	18	130
	saniert	12	4	4	4	4	15	5	12	5	15	13	16
HWB/NGF [kWh/m <sup>2</sup> a]	Bestand	412	96	253	154	544	133	299	290	97	241	68	602
	saniert	57	17	21	15	18	64	23	55	21	70	43	70
HWB/Vnetto [kWh/m <sup>2</sup> a]	Bestand	159	37	76	59	213	53	120	122	39	67	27	219
	saniert	21	6	6	6	9	25	9	21	8	20	16	29

## ENDENERGIE SPEZIFISCH

EEB/BGF [kWh/m <sup>2</sup> a]	Bestand	433	101	359	149	481	156	403	285	113	411	109	735
	saniert	92	74	76	29	44	112	54	72	53	110	82	56
EEB/Vbrutto [kWh/m <sup>2</sup> a]	Bestand	135	32	87	51	152	53	127	92	38	94	33	221
	saniert	27	24	20	10	13	37	17	22	18	30	28	17
EEB/NGF [kWh/m <sup>2</sup> a]	Bestand	537	122	503	196	712	226	524	415	138	515	126	1 021
	saniert	126	97	107	39	68	156	73	106	68	139	95	76
EEB/Vnetto [kWh/m <sup>2</sup> a]	Bestand	207	47	152	75	279	89	209	174	55	143	50	371
	saniert	46	36	34	15	32	62	29	40	28	40	34	32

## PRIMÄRENERGIE SPEZIFISCH

PEB/BGF [kWh/m <sup>2</sup> a]	Bestand	493	91	409	120	548	176	459	322	146	468	123	8
	saniert	83	19	16	23	13	125	12	16	59	124	93	17
PEB / Vbrutto [kWh/m <sup>2</sup> a]	Bestand	154	29	99	41	174	60	145	104	50	107	38	2
	saniert	24	6	4	8	4	42	4	5	19	34	31	5
PEB/NGF [kWh/m <sup>2</sup> a]	Bestand	612	110	573	157	812	254	596	469	178	586	142	11
	saniert	113	25	22	31	21	174	16	23	76	157	107	23
PEB/V netto [kWh/m <sup>2</sup> a]	Bestand	235	43	173	60	318	100	238	197	72	163	57	4
	saniert	41	9	7	12	10	69	6	9	31	45	38	10

Fig. 12: verschiedenste Formen der Auswertung von Energiekennzahlen im Vergleich

### 3.6 Subtask C - Konzept- und Komponentenanalyse

Die Arbeit in Subtask C war geprägt von einer im Wesentlichen auf technologische Fragestellungen fokussierten Diskussion. Fragen zur Verbesserung der Gebäudehülle wurden ebenso behandelt wie Fragen zu gebäudetechnischen Systemen oder zur Wahl der Energieversorgung. Die Diskussionen haben gezeigt, dass sich die Fragestellungen, die sich in den einzelnen teilnehmenden europäischen Ländern ergeben, durchaus zueinander große Ähnlichkeiten aufweisen. Vorgangsweisen und Konzepte sind in einem hohen Ausmaß kompatibel.

Handbuch zu  
Konzepten und  
Technologien

Die Ergebnisse der nationalen Projekte und der damit verknüpften Bearbeitung im Subtask C werden in einer Publikation mit der Bezeichnung „Advances in Housing renovation“ (Fig. 13) zusammengeführt werden. Darin wird der neueste Entwicklungsstand zu verschiedensten Sanierungstechniken bzw. deren Komponenten beschrieben. Die Publikation wird Einzelbeiträge zu den Themenbereichen Prozessgestaltung (Entscheidungsfindung, Kostenbeiträge, etc.), Gebäudehülle (Wärmebrücken, Fenster, Innendämmung, etc.) und Gebäudetechnik (Solarthermie, Lüftungssysteme, etc.) enthalten. Abgerundet wird das Informationsangebot mit einem Kapitel über eine vergleichende meßtechnische Evaluierung verschiedenster Wohnbauten. Das Handbuch kann voraussichtlich ab Herbst 2010 von der Homepage des TASK37 (<http://www.iea-shc.org/publications/task.aspx?Task=37>) frei heruntergeladen werden.

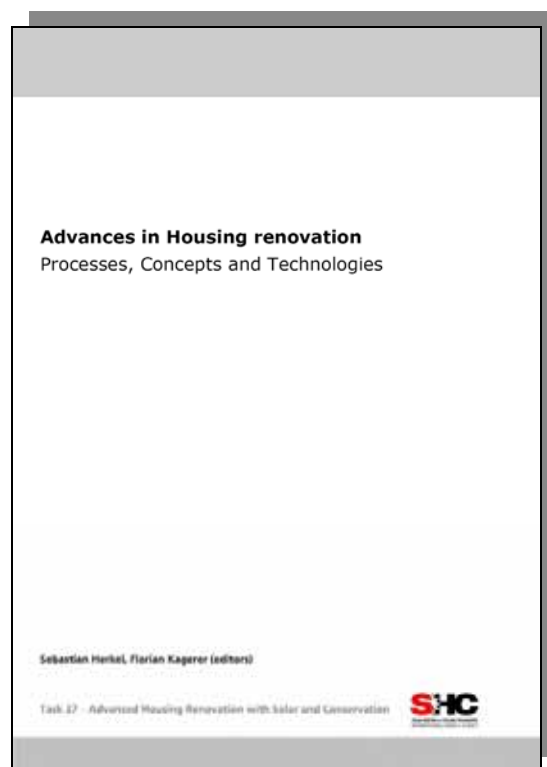

Fig. 13: Cover der Publikation aus Subtask C

Handbuch für  
Sanieren in kalten  
Klimazonen

Das norwegische Team erstellte zudem einen zusätzlichen Bericht, der sich insbesondere mit der Sanierung von Wohngebäuden in kalten Klimazonen beschäftigt. Dieser als "Guideline for Housing Renovation in Cold Regions" betitelte Bericht kann ebenso voraussichtlich ab Herbst 2010 von der Homepage des TASK37 unter (<http://www.iea-shc.org/publications/task.aspx?Task=37>) bezogen werden.

### 3.7 Die österreichischen Fachbeiträge

Team Austria ist an der Publikation „Advances in Housing renovation“ (Fig. 13) mit einem Hauptkapitel, zwei Subkapiteln und weiteren Einzelbeiträgen beteiligt, welche in der Folge kurz beschrieben und in den folgenden Kapiteln vollinhaltlich dargestellt werden.

Subkapitel

#### **Partizipation als Erfolgsfaktor**

Originaltitel:

Users participation as success factor for advanced housing renovation examples from the Austrian research programme “Building of Tomorrow”

Resümee:

Dieser Beitrag beschreibt und analysiert den Aspekt der Beteiligung von BewohnerInnen am Planungs- und Ausführungsprozess von Sanierungen in Wohngebäuden. Grundlage der Ausführungen ist eine Reihe verschiedenster Forschungsprojekte aus der Programmlinie Haus der Zukunft. Die Autorin kommt zu dem Schluß, dass aufgrund der österreichischen Rechtslage, hochwertige Sanierungen ohne die Akzeptanz der Bewohner nicht durchgeführt werden können. Sowohl finanzielle Anreize als auch die Einbindung wesentlicher Interessensvertreter können dabei als positive Anreize zur Akzeptanzverbesserung herangezogen werden. Eine zentrale Bedeutung kommt dem Dialog zwischen Planungsteam und Bewohnerschaft zu. Gegenseitige Information und Aufbau eines Verständnisses in Bezug auf die Bedürfnisse und Wünsche kann den gesamten Planungs- und Ausführungsprozess positiv beeinflussen und zu einem guten Sanierungsergebnis substantiell beitragen.

Volltext (englisch):

→ im „Anhang – Beiträge zu Subtask C“ (englisch)

Hauptkapitel

#### **Einsatz solarthermischer Systeme in Sanierungsvorhaben**

Originaltitel:

Active Solar Thermal Systems for Building Renovation

Resümee:

Dieser Beitrag beschreibt und analysiert den Einsatz solarthermischer Anlagen in Sanierungsvorhaben. Einsetzbare technische Lösungen, aktuelle Forschungsergebnisse und noch zu lösende Fragestellungen bzw. Forschungsbedarf werden dabei, geordnet nach vier Betrachtungsebenen, beschrieben und analysiert. Die oberste Betrachtungsebene „Region (XL)“ beschreibt den Ansatz das solarthermische Potential ganzer Regionen zu erfassen und mit dem regionalen Bedarf zu überlagern. Die Betrachtungsebene „Siedlung (L)“ betrachtet die Unterstützung von Fernwärmenetzen über solar betriebene Einspeisung. Die Betrachtungsebene „Gebäude (XL)“ beschäftigt sich mit der Integration der Kollektoren in die Gebäudehülle und beschreibt typische Varianten hydraulischer Verschaltungen und Vorstellungen zu weiterentwickelten Monitoringkonzepten. Die Betrachtungsebene „Komponente (S)“ umreißt die Bereiche Kollektorentwicklung und Speichertechnologie. In Summe werden auf den vier Betrachtungsebenen zahlreiche Aspekte der Integration von solarthermischen Anlagen in Sanierungsvorhaben aufgezeigt.

Volltext (englisch):

→ im „Anhang – Beiträge zu Subtask C“ (englisch)

Subkapitel

### **Aufgespritzte Innendämmung aus Zellulose ohne Dampfbremse**

Originaltitel:

Sprayed-on and trowel-applied internal cellulose insulation without vapour barrier

Resümee:

Dieser Beitrag beschreibt die Entwicklung einer im Rahmen eines Forschungsprojektes entwickelten aufgespritzten aus Zellulose bestehenden Innendämmung. Beschrieben werden die Entwicklung des Aufspritzverfahrens, die Ergebnisse eines ersten Feldtests an einem Versuchsgebäude und die durchgeführten hygrothermischen Simulationen. Der große Vorteil dieser Methode liegt, im Gegensatz zu Plattenwerkstoffen, in der problemlosen Anpassung der Dämmschicht an jegliche Formen des Untergrundes und an der durch die hydrophobe Wirkung der Zellulose wegfallenden Dampfbremse. Das dargestellte System wurde mittlerweile an weiteren Testgebäuden erfolgreich aufgebracht und wird derzeit in Forschungsprojekten weiterentwickelt.

Volltext (englisch):

→ im „Anhang – Beiträge zu Subtask C“ (englisch)

Beitrag zu

### **Lüftungsanlagen in Sanierungsvorhaben**

Originaltitel (voraussichtlich):

Ventilation systems in renovation

Resümee:

Dieser Beitrag behandelt den Einsatz mechanisch betriebener Lüftungsanlagen mit Wärmerückgewinnung in Sanierungsvorhaben. Nach einer Einführung in das Themengebiet und der Darstellung normativer Vorgaben werden bei der Planung und Installation von Wohnraumlüftungsanlagen häufig auftretende Fehler diskutiert und Lösungsansätze zu einer hohen Nutzerzufriedenheit aufgezeigt. Der zweite Teil des Beitrages beschreibt Entscheidungskriterien zur Systemwahl.

Volltext (englisch):

→ im „Anhang – Beiträge zu Subtask C“ (englisch)

Da zum Zeitpunkt der Erstellung des vorliegenden Berichtes die Arbeiten an der Subtask C Publikation „Advances in Housing renovation“ (Fig. 8) noch nicht abgeschlossen waren, kann der dargestellte Text von dem ebendort dargestellten Text Abweichungen enthalten.

### 3.8 Subtask D - Bewertung der Umweltwirkung

Im Rahmen von Subtask D entstand ein Handbuch mit dem Titel „Advanced and Sustainable Housing Renovation“. Diese als Leitfaden konzipierte Publikation richtet sich im Wesentlichen an die Berufsgruppe der Architekten. Beginnend mit der Darlegung grundlegender Aspekte der Nachhaltigkeit werden folgende Themenblöcke thematisiert:

- Lebensqualität (soziale Interaktion, sanfte Mobilität, Luftqualität, etc.)
- Energieverbrauch (Dämmung, Luftdichtheit, Solaranlagen, etc.)
- Wasserverbrauch (Trinkwasserverbrauch, Regenwassersysteme, etc.)
- Wasserbereitstellung (Wassermanagement und Wasserecycling)
- Müllvermeidung (Vermeidungsstrategien, Müllmanagement)
- Ressourcen (Landverbrauch, Graue Energie, Konstruktionen)

Die Kapitel sind in einzelne Datenblätter (sheet 001 bis sheet F02) aufgeteilt. In den Datenblättern wird ein Überblick über zahlreiche die Nachhaltigkeit einer Sanierung betreffende Planungsgrundlagen gegeben. Das ist Handbuch in Englisch verfasst und unter folgender Adresse frei verfügbar: <http://www.iea-shc.org/task37>



Fig. 14: Cover des Leitfadens zur Nachhaltigkeit in Sanierungsvorhaben

## 4 Ausblick

Implementierung eines neuen IEA TASKS

### **Implementierung eines neuen IEA TASKS**

Aufgrund der Aktualität der Aufgabenstellung thermische Sanierung und der erfolgreichen Zusammenarbeit im Rahmen des TASK 37 wurde vom Konsortium die Implementierung eines weiterführenden TASK angedacht. Ein großer Teil des Konsortiums steht einer Beteiligung in einem Nachfolge-Task äußerst positiv gegenüber. Von österreichischer Seite haben das Institut für Wärmetechnik (IWT), Austrian Institut of Technology (AIT) und die Österreichische Gesellschaft für Umwelt und Technik (ÖGUT) ihr Interesse bekundet. Insbesondere könnten die Aktivitäten die im Rahmen des im Oktober 2009 gestarteten dreijährigen Leitprojektes „denkmalaktiv“ in einen neuen Task eingebracht werden. Die Zielrichtung des neuen Tasks soll ebenso wie der Task 37 auf die hochwertige Sanierung ausgelegt sein, jedoch nicht auf den Wohnbau, sondern auf folgende Gebäudetypen fokussiert sein:

- Bürogebäude
- Einkaufszentren
- Hotels und Restaurants
- Schulen
- Schwimmbäder
- Kinderbetreuungseinrichtungen
- denkmalgeschützte Gebäude

Das “Concept Paper” des neuen Tasks mit dem Arbeitstitel: “ADVANCED RENOVATION IN NON RESIDENTIAL BUILDINGS” wurde am 16. bzw. 17. November 2009 vom Operating Agent des Task 37, Fritjof Salvesen dem SHC ExCo präsentiert, worauf der Beschluss gefasst wurde nach Vorschlag des Concept Papers eine Task Definition Phase einzuleiten. Der neue Task startet voraussichtlich im Jänner 2011.



## Anhang - Beiträge zu Subtask A

zum Bericht

### Die österreichische Beteiligung am IEA SHC TASK 37

#### Advanced Housing Renovation with Solar & Conservation

##### Inhalt

1.1	Key statistics for the residential sector .....	5
1.2	Potential for improvements.....	16
1.3	Driving forces and hindrances.....	21
1.4	Recommendations .....	31
1.5	References .....	32

Projekt im Rahmen der österreichischen Beteiligung am  
Energietechnologieprogramm der IEA. Im Auftrag des  
Bundesministeriums für Verkehr Innovation und Technologie.

Zusammenstellung T. Mach (Institut für Wärmetechnik, TU Graz) im August 2010





# Housing and Renovation in the Austrian Building Stock

Marketing and Communication Strategies (Subtask A)



Michlmair, Mach, Heinz, April 2009

## assignment

This document was produced within the framework of the IEA SHC TASK 37 – Advanced Housing Renovation with Solar & Conservation. The contained statistics and analyses are forming one of the groundworks for the marketing and communication strategies, done in Subtask A. Similar documents were worked out for several countries participating in TASK 37. The Austrian contribution was financed by the Austrian Federal Ministry of Transport, Innovation and Technology (BMVIT).

### Contact for further information:

Thomas Mach  
[thomas.mach@tugraz.at](mailto:thomas.mach@tugraz.at)  
 Institute of Thermal Engineering  
 Graz University of Technology  
 Inffeldgasse 25  
 A-8010 Graz



TEAM AUSTRIA



arsenal research  
 Ein Unternehmen der Austrian Research Centers



## summary

In this paper an overview of the Austrian building stock and ongoing developments in the building sector is given. Furthermore the state of the art of low energy- and passive houses and the typically used building technologies are described. In summary the following conclusions were worked out.

### Findings

- building stock ► The Austrian building stock consists of about 2.05 mio buildings (3.9 mio dwellings) and had a total useful floor area of about 299 mio sqm in the year 2001. It is dominated by detached houses and semi-detached houses, which together represent 76 % of all buildings. The buildings of the Austrian building stock are mainly privately owned (86.4 %). The average useful floor space per capita and also the average number of apartments per capita have been increasing for the last decades. According to the last census of buildings and apartments in 2001, an average useful floor space of 37.3 sqm was available for each inhabitant. By 2007 approximately 42.3 sqm per capita were available.
- heating demand ► The evolution of the heating demand of buildings with the building age is similar for many central-European countries. According to the building type and the age there is a range from about 230 kWh/(sqm<sub>GFA</sub>.a)<sup>1</sup> for buildings built close after the second world war down to 40 kWh/(sqm<sub>GFA</sub>.a)<sup>1</sup> for new apartment buildings. Central heating systems fueled by oil or natural gas are the most commonly used heating systems.

<sup>1</sup> GFA ... gross floor area

- CO<sub>2</sub>-emissions ▶ Since 1990 the CO<sub>2</sub>-emissions have been increasing continuously and reached 23.0 mio tons in 2003. Although the equivalent CO<sub>2</sub>-emissions in the sector "space heating and small consumers" were nearly constant in the period from 1990 to 2003 the aimed reduction for the time-period 2008 to 2012 due to the Kyoto-protocol will be nearly impossible to reach. To work against this development different action plans and research programmes were started.
- building law ▶ According to article 15 of the Austrian constitution the administration of the building law is task of the nine federal states. This means that Austria had so far nine different building codes, nine different regulations concerning new or refurbished buildings and nine different conditions in the subsidy schemes for new and existing buildings. By January 2009 the harmonisation of these building codes will be mainly finished. In the course of this harmonisation the directive of the European Parliament on the energy performance of buildings (EPBD) was implemented.
- renovation rate ▶ A substantial reduction of the energy demand and the CO<sub>2</sub>-emissions in the building sector can only be achieved by intensifying the thermal renovation rate. If the thermal renovation rate would be increased from the current 1 % to 3 %, it would last until the year 2016 to reach the desired savings of the Kyoto-protocol in the sector of housing.
- driving forces ▶ There are some major driving forces pushing thermal renovations in Austria forward. Additionally to the harmonisation of the building codes, the involved implementation of the EPBD and the building pass, especially subsidies for residential buildings act as such driving forces.
- hindrances ▶ In contrast to the mentioned driving forces there are also hindrances for the improvement of the thermal renovation rate. Especially legal aspects (legal framework of residential buildings) and economic aspects (rebound-effects) have to be mentioned as widespread obstacles. From the technical point of view service-life of insulation materials and building renovations combined with district heating networks are notable aspects.

### **Recommendations**

With regard to the composition of the Austrian building stock two groups of buildings should be mainly focused on in future renovation activities: Firstly it is necessary to improve the condition of detached and apartment buildings erected in the time period 1945 to 1961. A vast part of heating energy has to be spent for conditioning of those buildings. Secondly and even more important it is to limit the growing number of detached houses in Austria. Although this is the Austrians favored kind of living those buildings emit an enormous amount of CO<sub>2</sub>. Despite this there are still some hindrances, which should be diminished in order to advance the renovation rate. Especially legal aspects – mainly concerning rent law, cooperative housing law and condominium law – often cause problems in connection with renovations of buildings. Those laws should be modified in order to improve the surrounding conditions for good thermal renovations of buildings in the future.

## 1.1 Key statistics for the residential sector

### Stationary energy use

Fig. 1 and Fig. 2 show the growth of the final energy use in Austria from 1971 to 2006. It can be seen in Fig. 2 that the final energy use was doubled since 1971. The highest increase occurred in the sector of transportation – its share is nowadays nearly three times as high as forty years ago. The development of the final energy use is similar to the development of the economical structure. The share of the primary sector <sup>1)</sup> was decreased by 25 % and the secondary sector <sup>2)</sup> grew with a share of about 70 % slower than the total final energy use (increase of about 90 %). The tertiary sector <sup>3)</sup> was increased by about 140 % and grew faster than the total final energy use.

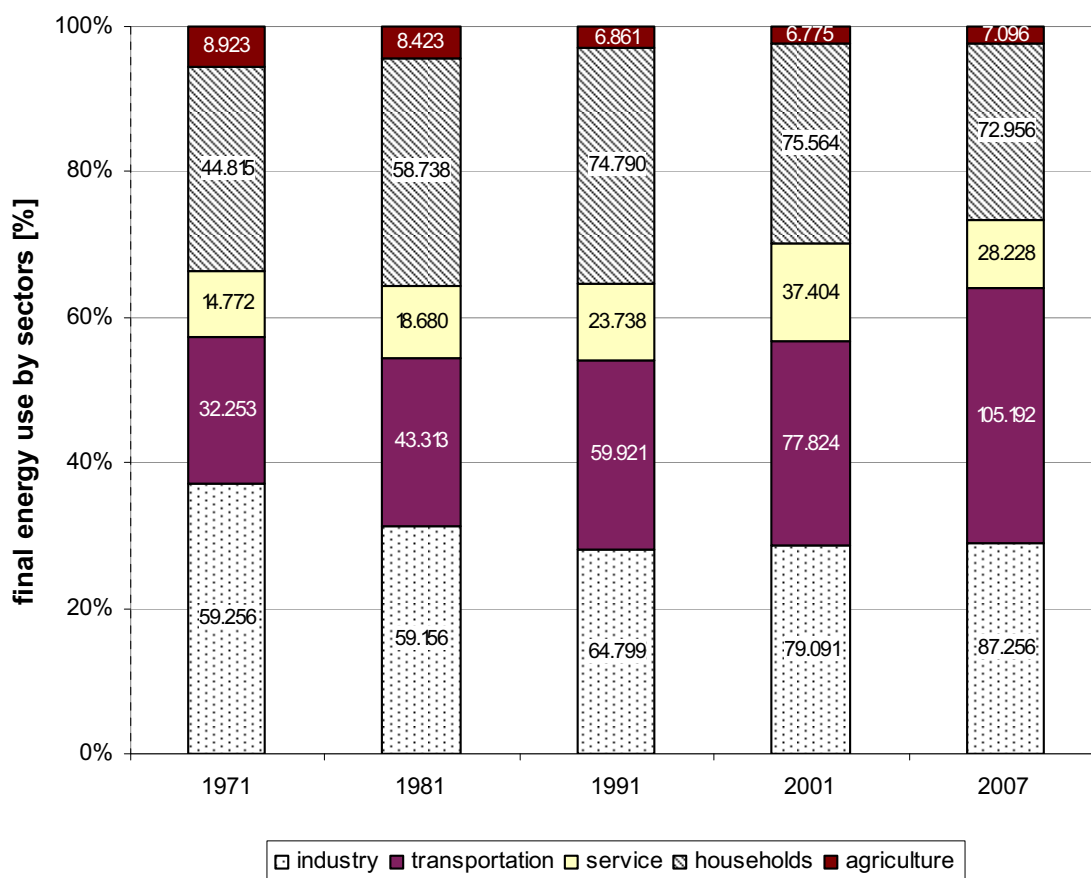

Fig. 1: Development of the annual final energy use by sectors since 1971, data source: [Statistics Austria 2009]

- 1) industry
- 2) transportation
- 3) service
- 4) households
- 5) agriculture

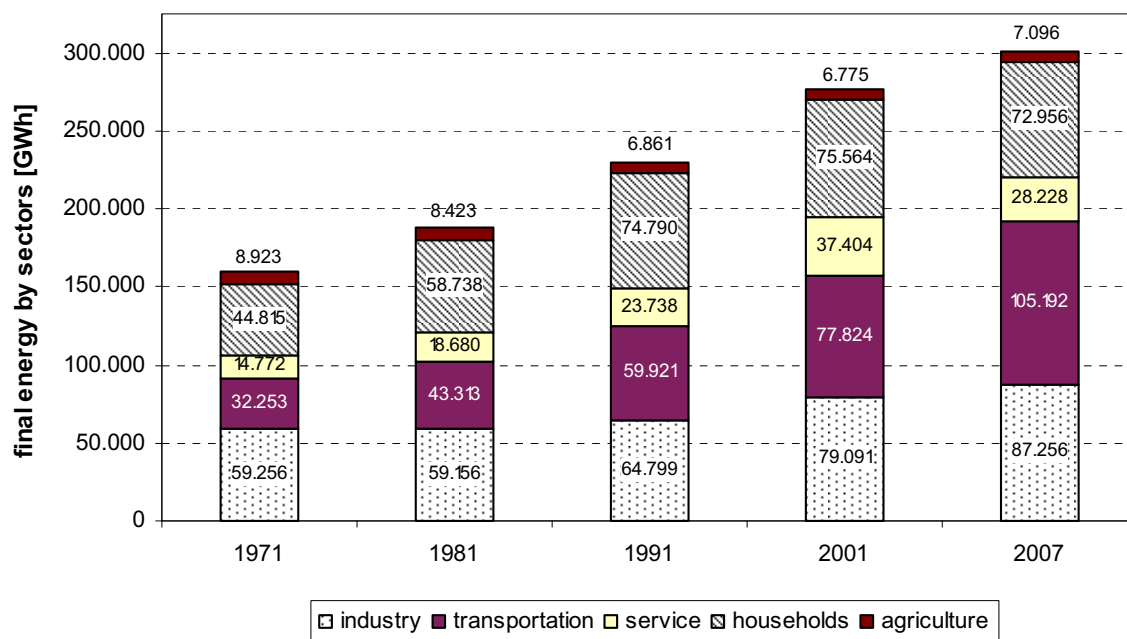

Fig. 2: Distribution of final energy use to sectors since 1971  
data source: [Statistics Austria 2009]

### Number and categories of buildings

The Austrian building stock consists of about 2.05 mio buildings (3.9 mio dwellings). It is dominated by about 1.56 mio detached houses or semi detached houses. This category, called “buildings with one or two dwellings” represents 76 % of all buildings in Austria. Nearly half of all Austrian dwellings can be related to this category (47 %). About 50 % of the dwellings are in buildings with “three to ten dwellings” and in buildings with “eleven or more dwellings”. The rest of the dwellings belong to the category “for associations” or to the category “non-residential buildings”. As shown in Fig. 3 the number of non-residential buildings is one order of magnitude smaller than the number of residential buildings. [Statistics Austria 2006]

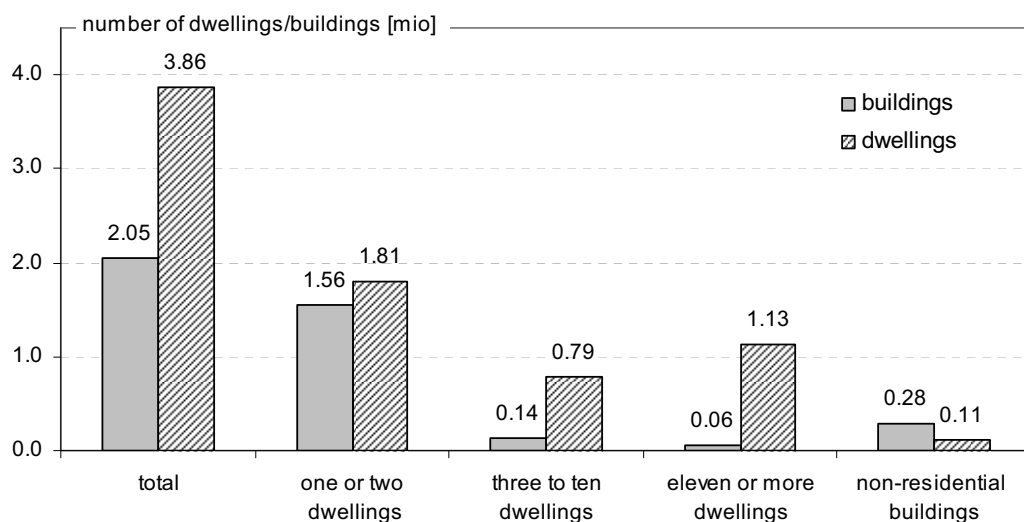

Fig. 3: The Austrian Building Stock classified due to the main use,  
data source: [Statistics Austria 2006]

### Useful floor area

Fig. 4 shows the growth of the total useful floor area in Austria in the time period 1971 to 2007. The useful floor area went up from about 182.0 mio sqm in 1971 to about 351.7 mio sqm. This is an increase of about 86 %. In the same time the population of Austria increased by 11 % from 7.5 mio to 8.3 mio.

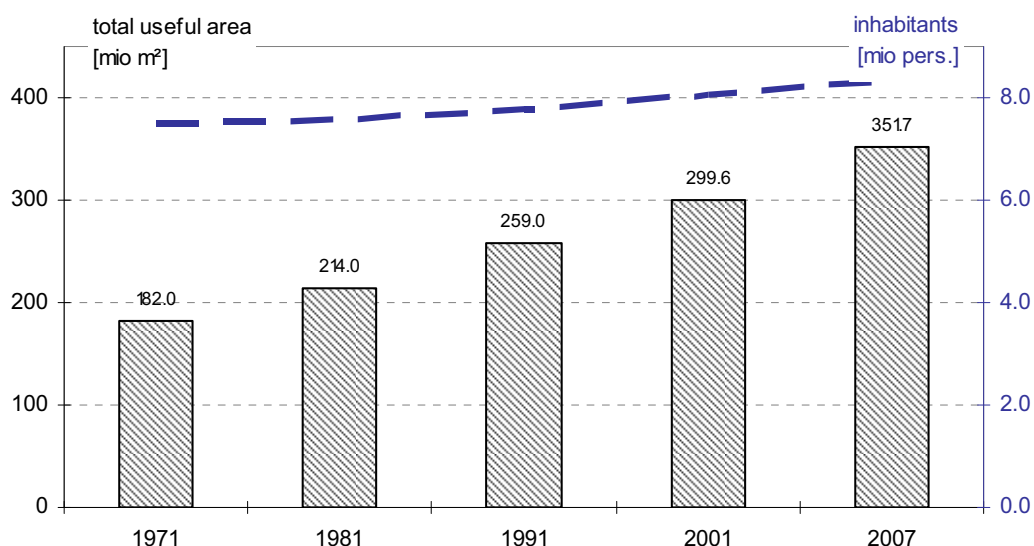

Fig. 4: Growth of total useful floor area in Austria in the period 1971-2007 (mio sqm). data source: [Statistics Austria 2007, Statistics Austria 2004]

These different developments of useful floor area and population result in an enormous increase of the average useful floor area per capita. It grew from 24.4 sqm per capita in 1971 to 42.3 sqm per capita in 2007 as it can be seen in Fig. 5.

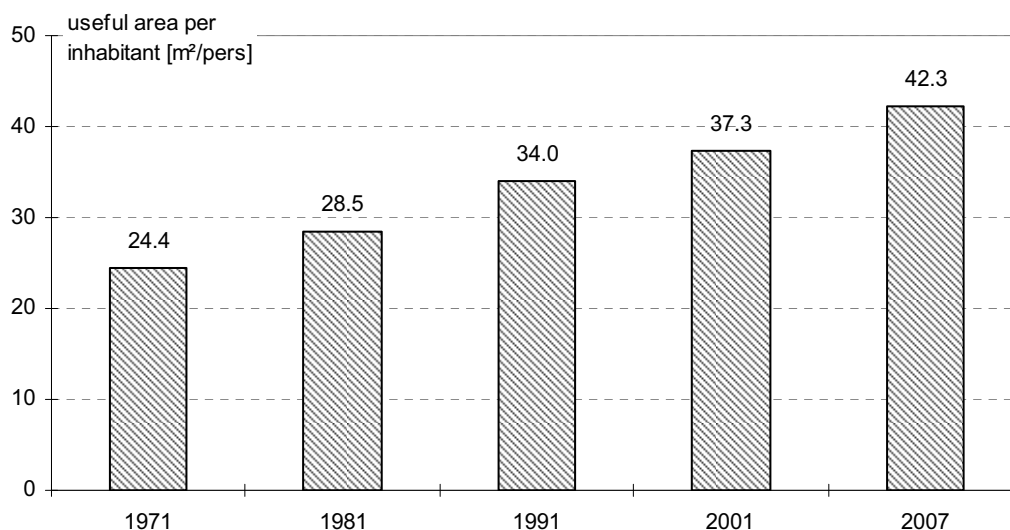

Fig. 5: Growth of total useful floor area per capita in Austria in the period 1971-2007 (sqm per capita). (data source: [Statistics Austria 2007, Statistics Austria 2004])

### energy use in the dwelling stock

The energy demand for space heating of residential buildings is dominated by buildings with one or two dwellings which spend about 68 % of the energy of all buildings. The share of the heating demand of multi dwelling buildings is only 28 % although about half of all dwellings are located in multi dwelling buildings. This is due to the higher V/A ratio (compactness) and therefore far less specific heating demand and additionally the smaller size of dwellings in multi-family houses in comparison to detached houses. The average dwelling size for buildings with one or two dwellings is 113 sqm floorspace per dwelling compared to 70 sqm floor space per dwelling for buildings with more than two dwellings. [Austrian Federal Economic Chamber 2006]

The evolution of the energy demand of buildings over the building age is similar for many central-European countries. Buildings with one dwelling built in Austria before 1945 have a specific useful energy demand for space heating of about 190 kWh/(sqm<sub>GFA</sub>.a) (Fig. 6). For dwellings built between 1945 and 1960 this value is 230 kWh/(sqm<sub>GFA</sub>.a) [Austrian Federal Economic Chamber 2006]. This period was the time of fast and cheap production of living space after the Second World War. Since then the specific energy demand of buildings steadily decreased due to the first oil price shock in the end of the 1970s.

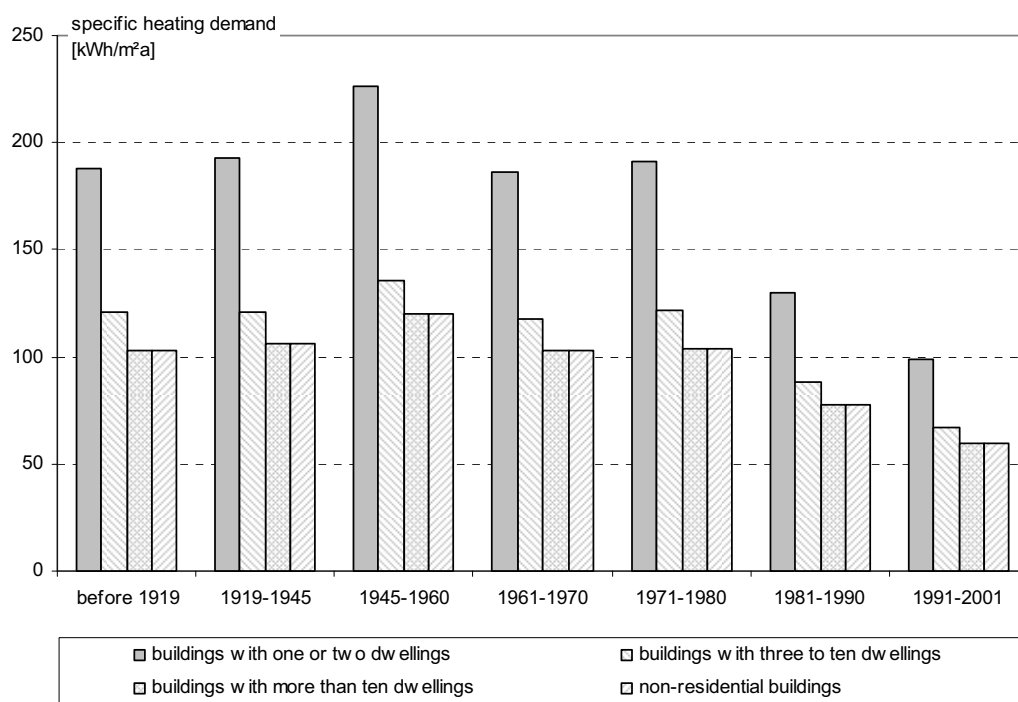

Fig. 6: Specific space heating energy demand (useful energy) of buildings with one or two dwellings, buildings with three to ten dwellings, buildings with more than ten dwellings and non-residential buildings in Austria classified by the building age. (data source: [Austrian Federal Economic Chamber 2006], origin data source: [Jungmeier et al. 1996])



This development was enabled by the availability of more effective insulation materials and advanced window technology, supported by a growing environmental concern. For buildings built after the year 1991 the useful heating demand is in the range of 100 kWh/(sqm<sub>GFA</sub>·a), which is already less than half of the values of the period from 1945 to 1960. For multifamily buildings the value was already 60–70 kWh/(sqm<sub>GFA</sub>·a) in 1991.

The trend is in the direction of values even far lower. With current (2006) building codes and subsidy schemes values of about 50-60 kWh/(sqm<sub>GFA</sub>·a) for single (and two) dwelling buildings and 40-50 kWh/(sqm<sub>GFA</sub>·a) for multi dwelling buildings are achieved. Houses built due to the Passive house concept show that the space heating demand can be decreased to 15 kWh/(sqm<sub>GFA</sub>·a).

The requirements to reach such small heating demands are optimal thermal insulation of the building envelope and effective mechanical ventilation with air heat recovery. Thus the specific heating demand of new buildings decreased dramatically in the last 50 years. [Austrian Federal Economic Chamber 2006]

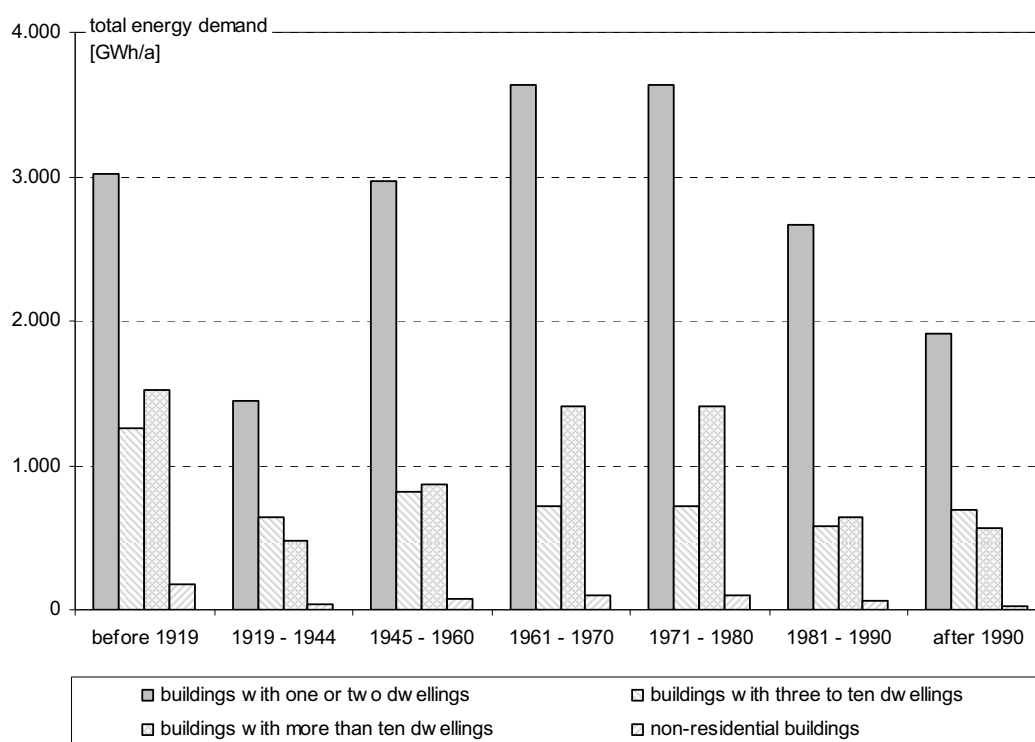

Fig. 7: Total energy demand of buildings with one or two dwellings, buildings with three to ten dwellings, buildings with more than ten dwellings and non-residential buildings in Austria classified by the building age. (data source: [Statistics Austria 2004], [Statistics Austria 2006], [Jungmeier et al. 1996])

## Implemented heating systems

The evaluation of the Austrian building stock with regard to the used heating system shows a clear dominance of central house- or apartment heating systems. Fig. 8 shows that a total of 74.6 % of all principal residences is heated with some kind of a central heating system. District heating is used seldom in the sector of detached and semi-detached houses. The fraction of buildings supplied by district heating is increasing with an increasing size of the building, whereby 12.2 % of all principal residences are supplied by district heating. The fraction of buildings heated with single stoves has been decreasing for the last century, and was about 11.7 % in the year 2001. [Statistics Austria 2007]

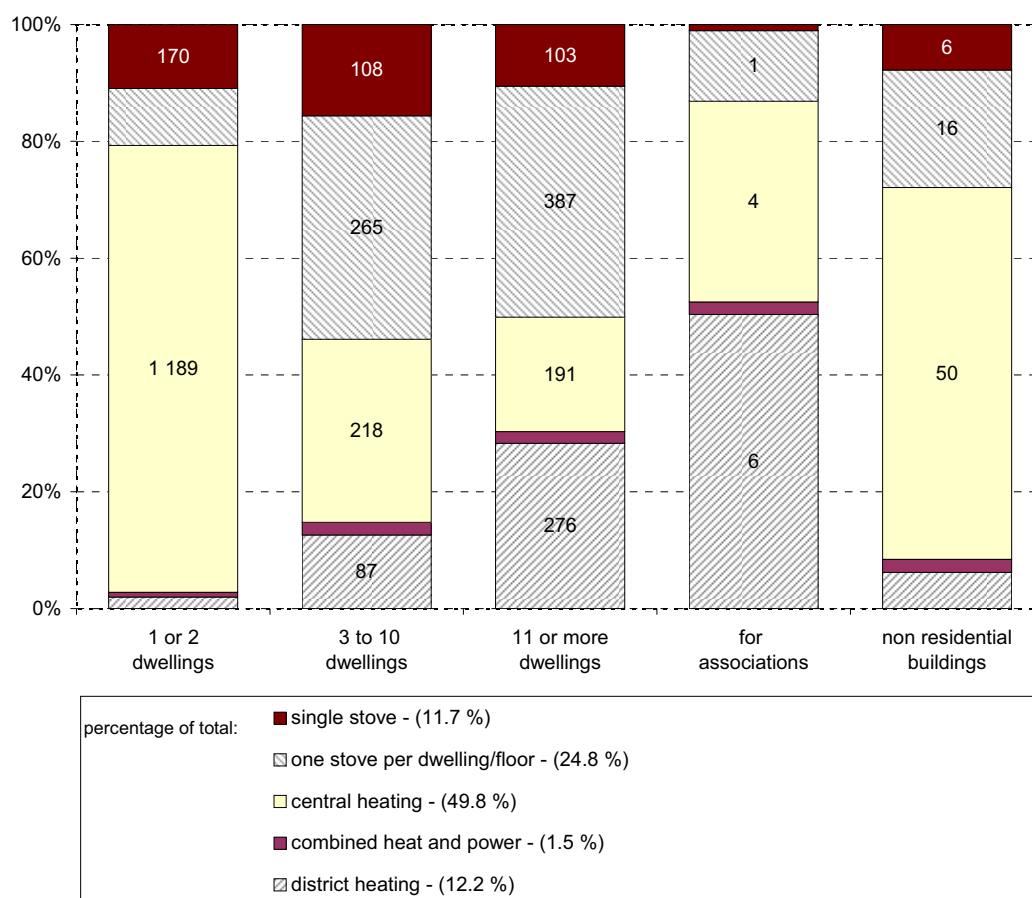

Fig. 8: Heat delivery systems in Austrian dwellings per building type in 2001. The figures inside the columns show the number of systems in 1000. (data source: [Statistics Austria 2007])

### Used energy sources for heating supply

The analysis of the energy sources used for the heating of buildings (Fig. 9) shows a dominance of fossil fuels. A total of 61.2 % of the principal residences in Austria is supplied with heat out of gas, oil, coal and briquets. The data published by Statistics Austria show a continuous increase of the gridbound supply with gas and district heating in the last decade. The fraction of coal, coke and briquets has decreased from about 30 % in the year 1980 to about 2.9 % in the year 2001. [Statistics Austria 2007]

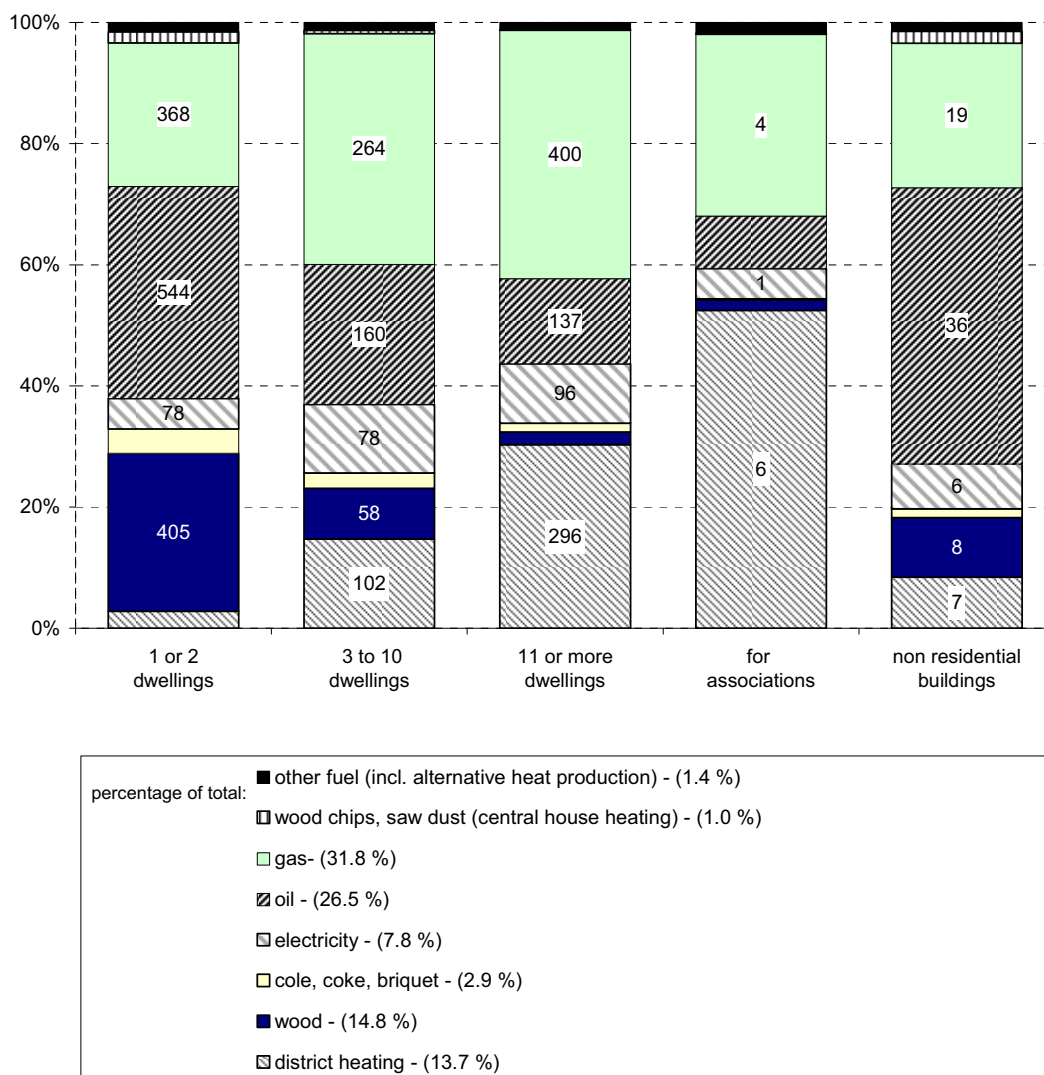

Fig. 9: Energy sources per building type for 3.32 mio Austrian dwellings. The figures in-side the columns show the number of systems in 1000. (data source: [Statistics Austria 2007])

### CO<sub>2</sub>-emissions caused by the building stock

Fig. 10 and Fig. 11 show the overall and specific CO<sub>2</sub>-emissions caused by the Austrian building stock (divided into different building types and building ages). The high total emissions of single family houses are mainly due to the big number of existing buildings of this category and the high specific space heating energy demand (see Fig. 6). Especially detached houses of the period from 1961 to 1980 are producing a major part of the total emissions.

Therefore it can be seen that it is of great importance to reduce the space heating demand – especially of one-family-houses built in the years 1961 to 1980.

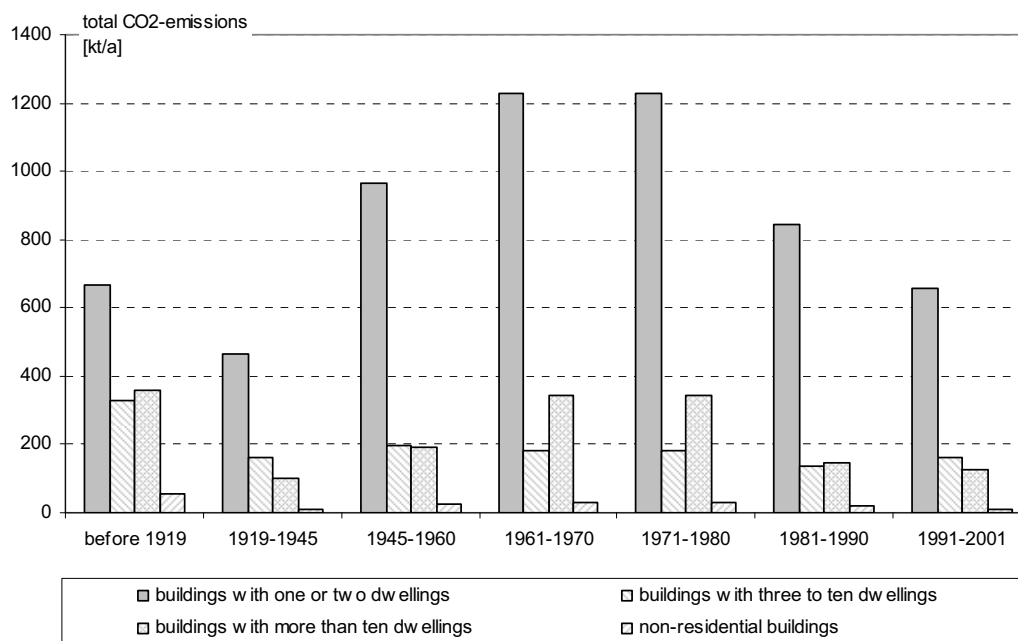

Fig. 10: Total CO<sub>2</sub>-emissions of buildings with one or two dwellings, buildings with three to ten dwellings, buildings with more than ten dwellings and non-residential buildings in Austria classified by the building age. (data source: [Austrian Federal Economic Chamber 2006])

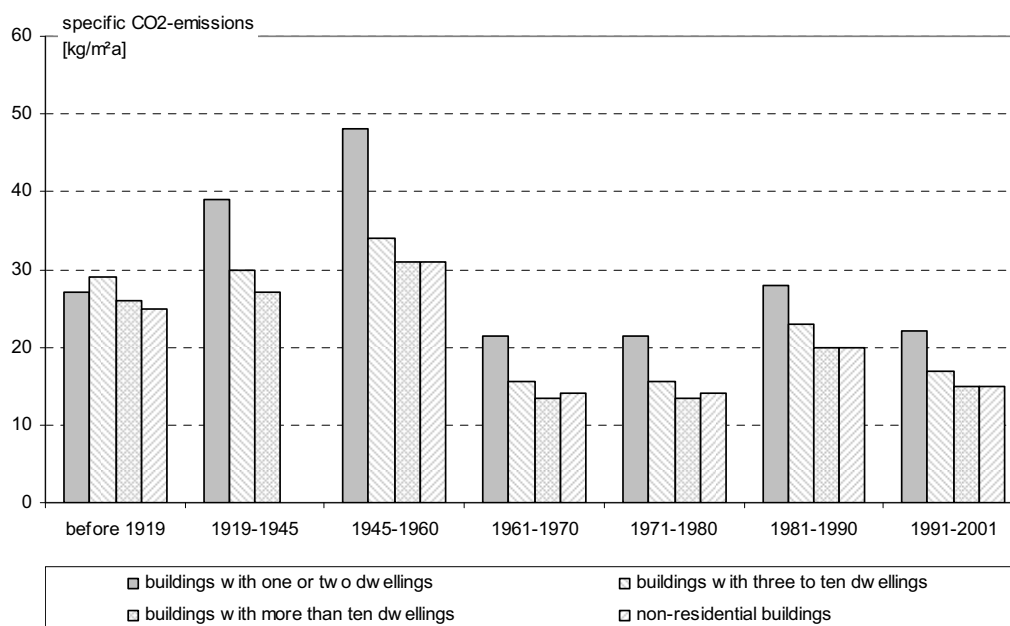

Fig. 11: Specific CO<sub>2</sub>-emissions of buildings with one or two dwellings, buildings with three to ten dwellings, buildings with more than ten dwellings and non-residential buildings in Austria classified by the building age. (data source: [Austrian Federal Economic Chamber 2006])

### Current renovation activities

In Fig. 12 it can be seen that retrofit activities in Austria are mainly carried out by domestic private persons. Those persons are responsible for the renovation of nearly 95 % of the houses with one or two dwellings and for 46 % of houses with three and four dwellings. The second largest group of investors responsible for renovations are non-profit associations, municipals and other companies like banks or other corporations (mainly for houses with three and four dwellings). On the one hand it is necessary to adapt and create ideas to get private owners to invest in renovations, because they are dominating the ownership. On the other hand there is a potential in the field of buildings with three or more dwellings owned by municipals and nonprofit organizations. Especially these owners should be interested in setting positive examples.

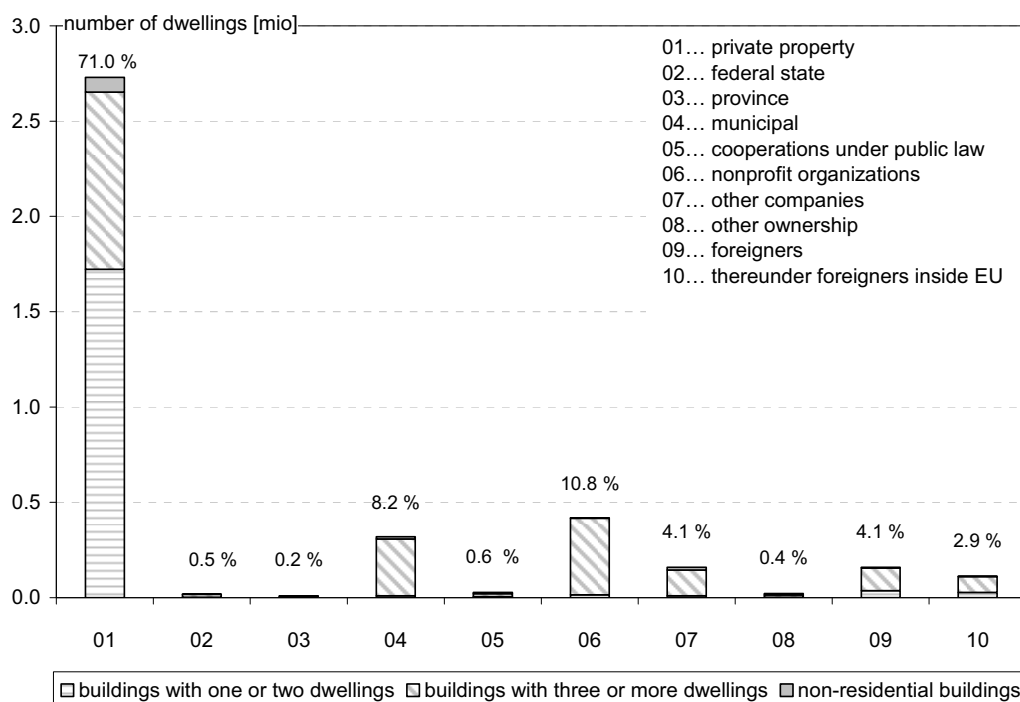
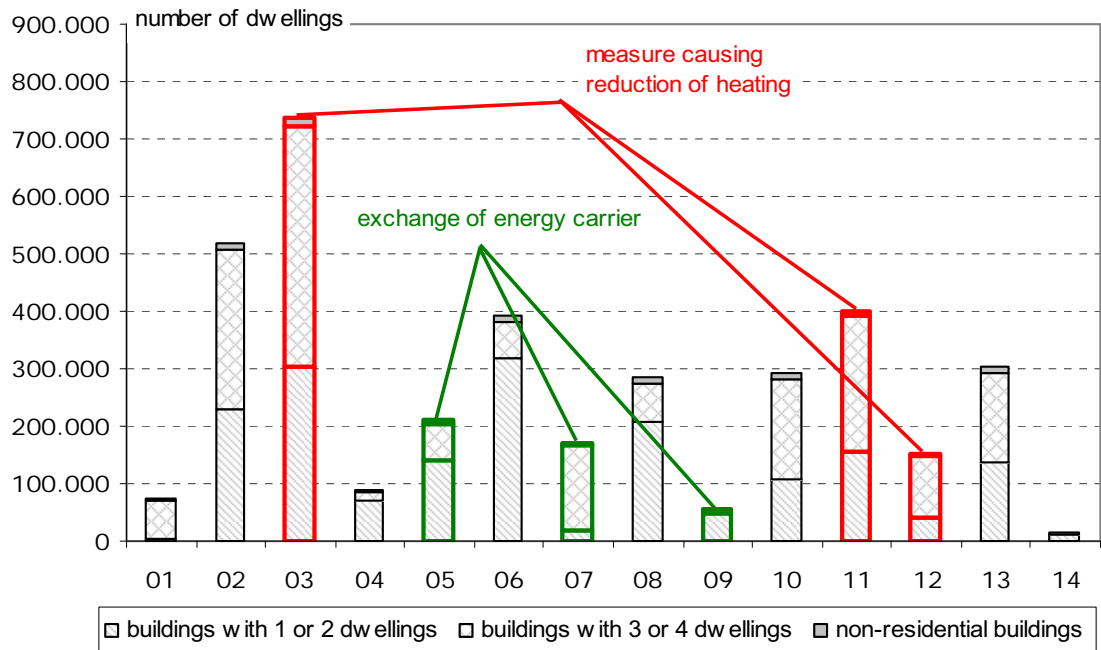

Fig. 12: Overview of the ownership of buildings in Austria. (data source: [Statistics Austria 2004])

Fig. 13 and Fig. 14 give an overview of the renovation activities (period 1991-2001) in the building sector in Austria. The most common renovation measure with effect on the heat demand of buildings is the renewal of windows (measure 03), followed by the renovation of façades with additional heat insulation (11) and other measures of heat protection (12). The “change of the energy carrier” (measures 05, 07 and 09) can have an effect on the CO<sub>2</sub>-emissions if the new energy carrier is a renewable energy source. Except for the measure “installation of alternative heating systems” (09) both an increase and a decrease of CO<sub>2</sub>-emissions is possible. The analysis in Fig. 13 shows that the largest parts of the renovation activities are no thermal renovations.



- 01...Installation of lifts
- 02...Renew of roof
- 03...Renewing of windows in most of the building
- 04...Connection to fresh water network
- 05...Connection to gas network
- 06...Connection to waste water network
- 07...Connection to district heating system
- 08...Installation of a central heating system
- 09...Installation of "alternative" heat delivery systems
- 10...Renovation of facade without insulation
- 11...Renovation of facade with insulation
- 12.. Other heat demand reduction measures
- 13.. Installation of water and sanitary equipment
- 14...Installation of decentralized waste water treatment plant

Fig. 13: Overview of the renovation activity in Austria, number of dwellings renovated in the period from the year 1991 to the year 2001 concerning different measures. (origin figure: [Austrian Federal Economic Chamber 2006], data source: [Statistics Austria 2004])

Fig. 14 points out the annual renovation rate for several measures concerning thermal renovation in the Austrian building stock in the period from 1991 to 2001. These six analysed measures have annual (thermal) renovation rates of below 2 %. Taking into account that many of those measures were carried out in combination with each other (renovation of façade and exchange of windows and possibly also other renovation activities), there might be doubts about the total annual renovation rate of 1 %. Maybe this figure is in fact even lower.

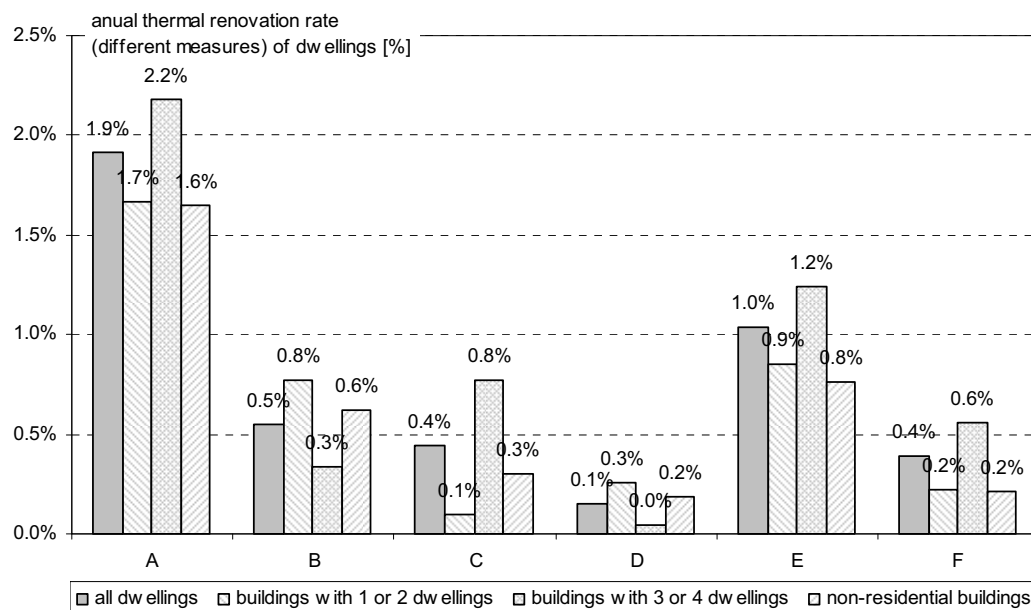

- A ... renewing of windows in largest part of the building
- B ... connection to gas network
- C ... connection to district heating system
- D ... installation of "alternative" heat delivery system
- E ... renovation of façade including additional insulation
- F ... other thermal renovation activities

Fig. 14: Annual renovation rate for several measures of thermal renovation. (data source: [Statistics Austria 2004])

### Ownership

The buildings of the Austrian building stock (Fig. 15) are mainly (86.4 %) privately owned. The predominant share (1.48 Mio.) is represented by one- or two-family houses. The second biggest category of building owners (other companies) is with a share of about 3.2 % more than one order of magnitude smaller. 61 % of the buildings registered as non-residential are also privately owned. [Statistics Austria 2006]

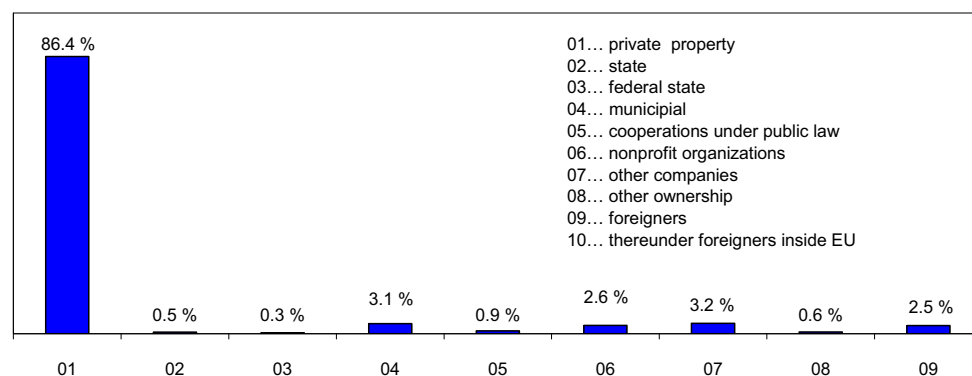

Fig. 15: Percentage of buildings in the Austrian building stock, classified by ownership (data source: [Statistics Austria 2006])

## 1.2 Potential for improvements

### Potential for reduction

The breakdown of the Austrian CO<sub>2</sub>-emissions according to sectors shows the highest increase in the sector of traffic. For the basic year of the Kyoto-protcoll 1990 the equivalent CO<sub>2</sub>-emissions of the traffic sector are quoted with 12.8 mio tons. Since 1990 the emissions have increased continuously and reached 24.4 mio tons in 2005. The equivalent CO<sub>2</sub>-emissions in the sector "space heating and others" were nearly constant in the period from 1990 to 2005. The small increase from 14.9 to 15.6 mio tons is caused by the very cold winter 2004/2005. As the number of apartments has increased by about 15 % in the same period, there has been an according reduction of the specific emissions.

Due to the "Austrian strategy to reach the Kyoto-goals" the sector "space heating and others" has to be reduced until the period 2008 to 2012 by an average of 4.0 mio tons (about 28 %) compared to the year 1990 [BMLFUW 2002]. This reduction should be reached by several methods which are defined in this strategy. One of the twenty-six measures in the sector "space heating and small costumers" is the doubling of the thermal renovation rate. The absolute value of the equivalent CO<sub>2</sub>-emissions in this sector stayed nearly constant in the period from 1990 to 2003 [Austrian Federal Environment Agency 2007]. This means that the CO<sub>2</sub>-emissions have to be reduced by about one mio tons per year until 2012 to finally reach the self-imposed goals of this sector.

In the year 2007 the Austrian government reacted on missing the – partially self-imposed, partially EU-specified – targets ("reduction goal 2002"). The "Austrian strategy to reach the Kyoto-goals" was adopted and new figures ("reduction goal 2007") for the eight sectors were presented (see Fig. 16).

sector	emissions 1990	reduction goal 2002	emissions 2005	reduction goal 2007
space heating and others	14.9	10.2	15.6	11.9
energy generation	13.7	12.4	15.9	13.0
waste management	9.6	3.7	2.9	2.1
traffic	12.8	16.3	24.4	18.9
industry	22.3	20.8	24.7	23.2
fluoridated gases	1.6	1.8	1.3	1.4
other relevant emission	1.0	0.7	1.2	0.9
agriculture	9.1	4.4	7.8	7.1
<b>domestic sum</b>	<b>79.0</b>	<b>70.6</b>	<b>93.2</b>	<b>77.8</b>
contribution JI/CDM		n.q.		-9.0
<b>target of Kyoto-protcoll</b>		<b>67.6</b>		<b>68.8</b>

Fig. 16: Figures from the "Austrian strategy to reach the Kyoto-goals" for eight sectors; primarily fixed figures (2002) and figures of adopted strategy (2007). (data source: [BMLFUW 2002], [BMLFUW 2007])



The following chapter which is illustrating the potentials for improvements by raising the thermal renovation rate has been worked out by Markus Michlmair in 2007 and was published in the article "Thermal Retrofit of buildings in the Czech Republic and Austria" in the book "Czech-Austrian Energy Expert Group, CZ-AT EEG Research Paper Series" in December 2007 [Michlmair et al. 2007]. The original version of this article has been worked out by Wolfgang Streicher and was published in German language in [Austrian Federal Economic Chamber 2006].

### Importance of the thermal renovation rate

With regard to the age of the buildings the period of 1961 to 1980 has the highest fraction of the total CO<sub>2</sub>-emissions in the Austrian building stock, because the building activity in this period was at an absolute maximum. A reason for this fact was the priority to create cheap living space (Fig. 10). The highest specific emissions (CO<sub>2</sub>-emissions caused by space heating per sqm of floor area) are caused by buildings of the period between 1941 and 1960 due to the requirement to create a lot of cheap living space directly after the war (Fig. 11). In accordance with these facts the total CO<sub>2</sub>-emissions in the building sector can only be clearly reduced by thermal renovation of the existing building stock. Fig. 17 shows the effects of thermal renovations of detached houses and multi-family houses. It can be seen, that renovation activities and exchanges of the energy source on the field of detached houses effect a five times higher reduction of CO<sub>2</sub>-emissions than on the field of multi-family houses. To achieve a reduction of 4 mio tons of CO<sub>2</sub> until 2012 (sectoral goal to fulfil requirements of the Kyoto protocol [BMLFUW 2002]), starting in 2006 a renovation rate of about 5 % would have been necessary. If the renovation rate will increase from the current 1 % to 3 %, it would last about ten years to reach the desired savings of 4 mio tons of CO<sub>2</sub>-emissions (Fig. 17). [Austrian Federal Economic Chamber 2006]

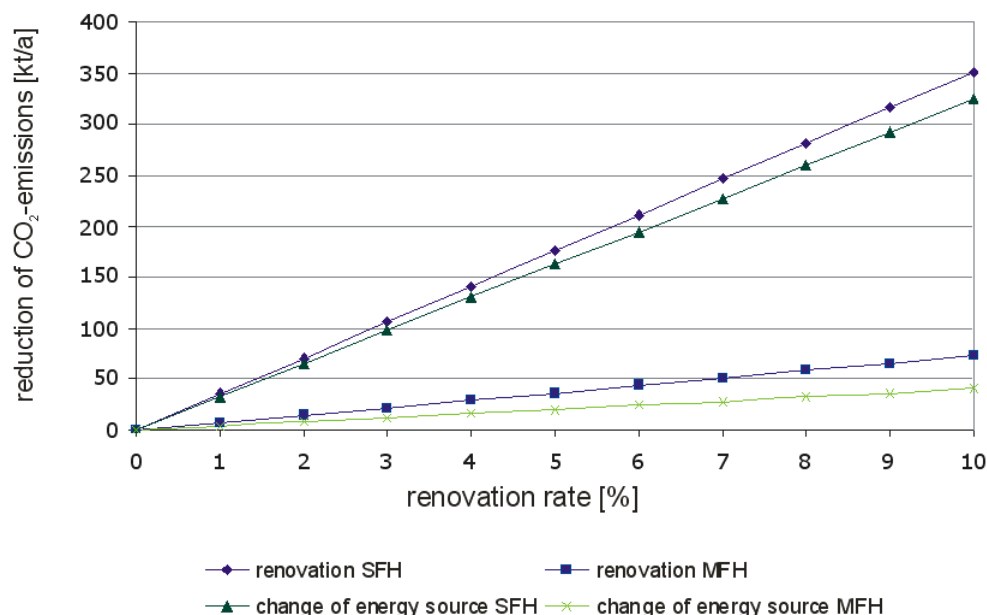

Fig. 17: Illustration of the potential for reduction of CO<sub>2</sub>-emissions due of single family buildings (SFH) and multi family buildings (MFH) due to a raise of the renovation rate and change of heating energy source to renewable energy (20 % change from oil to biomass/solar energy) for one- and multi-family dwellings [Austrian Federal Economic Chamber, 2006]

*The following chapters show the current situation of thermal renovations and maintenance-work in Austria respectively ideas to overcome this situation by changing the legal framework or similar methods. It will give an overview of upcoming costs (single measures and economic costs) on the one hand and benefits on the other hand. It has been originally worked out by Wolfgang Streicher and was published in German language in the report "Innovation und Klima" of the Austrian Federal Economic Chamber in 2006 [Austrian Federal Economic Chamber 2006]. In 2007 it was translated to English by Markus Michlmair and was published as a part of [Michlmair et al. 2007].*

### **Costs of thermal retrofit measures**

The costs for renovation measures are always depending on the particular task and the quality level of the measure. Nevertheless for the relation between costs of renovation-measures and their thermal benefit a ranking by trend can be identified (data source: [Austrian Federal Economic Chamber 2006]):

### **Improvement of conservation**

- ▶ Additional insulation of exterior walls is highly cost-effective. Reasons for the high costs of this measure are not the insulation materials but the erecting of the scaffold and the preparation of the façade.
- ▶ An additional insulation between the top floor and the unheated garret (e.g. apply walk able insulation boards) as a thermal- and cost-effective measure for energy-conservation.
- ▶ An additional insulation between the unheated basement and the ground floor (ceiling height of the basement has to be high enough) as a thermal- and cost-effective measure for energy-conservation.
- ▶ In some cases the elimination of high capacity thermal bridges can be done by a small effort and low costs.

### **Replacement**

- ▶ The replacement of windows is also a good measure especially in older buildings (the window area is smaller than in new buildings). A problem of this action is that occupants have to leave their dwellings for a certain time. Nowadays it is possible to change windows in one day.
- ▶ The moment when an exchange of the boiler or other main parts of the heating system is necessary is well suited for the installation of energy-efficient building equipment.

### **Additional building services**

- ▶ The implementation of a ventilation-system with heat recovery will reduce heat losses due to ventilation dramatically. This measure is only useful after increasing air-tightness of the building envelope.
- ▶ The use of solar thermal energy is very cost-effective especially for the generation of domestic hot water. The installation of solar panels does not depend on retrofit-measures of the building, it is useful to combine it with an adaptation of the heating system.

The costs of the thermal renovation and the correlation to the benefits (reduction of emissions) cannot be done easily, because of two reasons:

- 1.) The reasons for renovating the buildings are different and not only in reducing CO<sub>2</sub>-emissions but also in increasing comfort of living.
- 2.) The cost of construction workings cannot be divided into the work for reducing CO<sub>2</sub>-emissions and other workings (scaffold will be erected to renew the façade and not only to do thermal renovation)

#### Ecological benefit

Fig. 18 shows the benefit of an increase of the renovation rate. Depending on the future renovation rate a reduction of the current CO<sub>2</sub>-emissions up to 60 % until 2016 should be possible. The costs of such a reduction can be seen in Fig. 19.

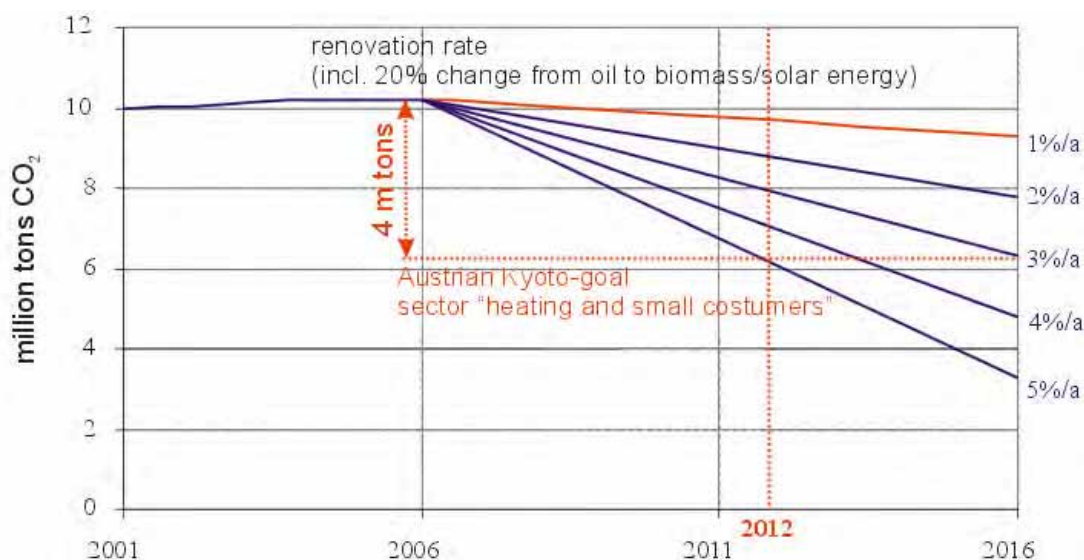

Fig. 18: Trend scenario of thermal renovation and fuel switch of all Austrian dwellings (origin figure: [Austrian Federal Economic Chamber, 2006], basic data from [Statistics Austria 2004])

#### Economic costs and benefit

The connection of an increase of the thermal renovation rate on the one hand and economic costs as well as a reduction of CO<sub>2</sub>-emissions and employment rate in Austria on the other hand is shown exemplarily in the following two studies:

##### 1. WIFO-study

Every increase of the renovation rate of one percent would cause an average annual increase of the employment until 2010 of 760 persons and the unemployment will decrease by 590 people annually. In the fifth year the positive impact on the employment will be 11.000 persons. The annual costs to increase the renovation rate from current 0.5 % to 2 % are expected with 525 mio € per year.

## 2. FGW-study

This study expects that a linear extension of the current renovation rate until 2010 will cause a reduction of the CO<sub>2</sub>-emissions of approximately 0,53 mio tons. The assumption of an increase of the current renovation rate to a renovation of 30 % of the existing building stock in ten years would result in 300.000 renovated dwellings in this period. Estimated costs of 60.000 € for each flat arise total investments of 18 billion € in those ten years. It is assumed, that about 50 % of the total investments would be done anyway. Therefore 900 mio € will be spent additionally per year. These investments cause an increase of employment in building industry of 16.000 jobs in ten years.

szenario "WIFO"	
specific costs of renovation	270 €/m <sup>2</sup> a
average size of dwellings	90 m <sup>2</sup>
costs of renovation per dwelling	24.300 €/dwelling
reduction of emissions per percentage point	75.000 to CO <sub>2</sub> /a
investment costs per percentage point	806 Mio €/a
szenario "FGW"	
specific costs of renovation	400 €/m <sup>2</sup> a
costs of renovation per dwelling	60.000 €/dwelling
reduction of emissions	105.000 to CO <sub>2</sub> /a
investment costs	1.800 Mio €/a
additional costs for thermal renovation	900 Mio €/a

Fig. 19: Key data of two scenarios for renovation [Michlmair et. al 2007]

Non-residential buildings – like office buildings, schools, hotels or public buildings – additionally emit 5 mio tons of CO<sub>2</sub> per year. It can be supposed that 20 % of these emissions can be reduced due to better management of the used energy and small constructural adaptations.

Summarizing it can be said, that the economic benefit of an increase of the renovation rate of 1 % will be between 5300 (FGW) and 11000 persons (WIFO) in five years. These retrofitting activities will cause expenses of 806 (WIFO) to 1800 mio € (FGW).

## 1.3 Driving forces and hindrances

In this chapter some legal aspects, economic aspects and technical aspects for the driving forces and hindrances for thermal renovation are worked out.

### Building law

According to article 15 of the Austrian Constitution the administration of the building law is task of the nine federal provinces. This means that Austria had so far nine different building codes, nine different regulations concerning new or refurbished buildings and nine different conditions in the subsidy schemes for new buildings and renovations.

Since several years there have been great efforts to change this annoying situation. In 2006 an agreement between the Austrian state and the nine federal provinces, called article 15a agreement, was accomplished [Amt der Steiermärkischen Landesregierung 2005]. This agreement aims to the harmonisation of all nine building laws referring to only one universally valid body of rules and regulations including the general quality standards for new and refurbished buildings. The harmonized body of rules will consist of the following six different directives mainly based on the “essential requirements” of the construction products directive (CPR) [European Parliament 1989]:

- Directive 1: mechanical strength and stability
- Directive 2: fire control
- Directive 3: environment, healthiness and hygiene
- Directive 4: safety and accessibility for disabled persons
- Directive 5: noise protection
- Directive 6: energy saving and thermal insulation

By the end of 2008 all Austrian Federal provinces have agreed to implement at least directive 6 concerning energy saving and thermal insulation of the harmonized building code as their building law. Four Federal provinces implemented all directives, the other provinces will hopefully follow soon.

### Implementation of the EPBD

The European Commission released the “Directive 2002/91/EG of the European Parliament and of the Council of 16 December 2002 on the Energy Performance of Buildings (EPBD)” [European Parliament 2003]. The directive had to be set into force in January 2006, but there is the possibility to use a three year implementation period. The EPBD is requesting the implementation of an energy pass (certificate) for each building [European Parliament 2003]. In Austria the implementation started in January 2008, when it got obligatory to certificate an energy pass for new buildings. By January 2009 existing buildings will need a building pass too [Eiper & Streicher 2006].

The legal framework for the implementation of the EPBD was set by enacting the “Energieausweisvorlage-Gesetz (EAV-G)” (law concerning the submission of energy passes) [Austrian Republic 2006]. This law defines the obligation of the federal provinces to implement the relevant articles into their building codes. The Federal provinces themselves refer in their building codes on directive 6 of

the harmonized body of rules worked out by the OIB – the Austrian Institute of Construction Engineering [OIB 2007a]. The contents and the calculation method of energy passes are defined in several national standards [OIB 2007b]. A common feature of all nine building codes has been the definition of a minimum standard for the heat protection of several building components. Since the beginning of these regulations the upper limits of the allowed U-values have the tendency to fall. This feature is nowadays defined in directive 6 of the harmonized body of rules. A number of limits for U-values can be seen in Fig. 20

structural element	U-value [W/m <sup>2</sup> K]
walls against ambient air	0.35
roofs	0.20
walls and floors to ground	0.40
doors	1.70
windows in residential buildings	1.40

Fig. 20: Maximum U-values defined in directive 6 of the harmonized Austrian body of rules. [OIB 2007a]

Besides upper limits for U-values of structural elements directive 6 of the harmonised body of rules also defines upper limits for the heating energy demand of buildings. Separated into the categories “major renovations” and “new buildings” dependent on the compactness of the building upper limits are fixed as it can be seen in

Fig. 21. There are two levels of requirement: From getting into force until the end of 2009 the maximum value (mainly for detached houses) for new buildings is 78 kWh/(sqm.a) and for renovations 102 kWh/(sqm.a). The limits will be tightened by January 2010 – the maximum space heating demand for new buildings will be 66.5 kWh/(sqm.a) and for renovations 87.5 kWh/(sqm.a).

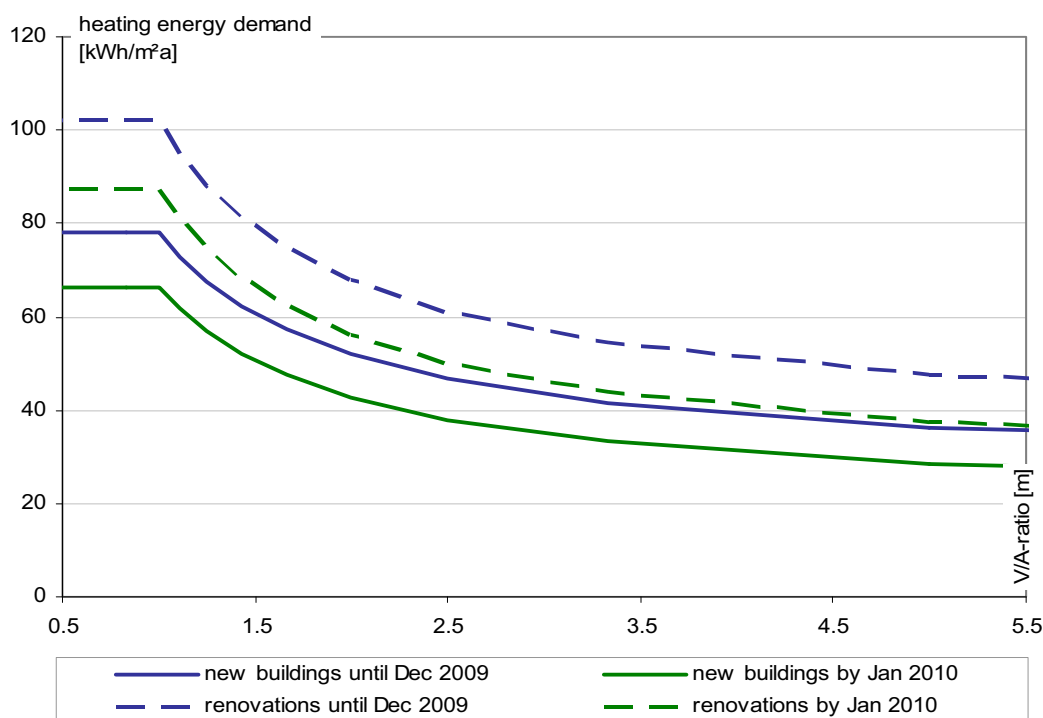

Fig. 21: Upper limits for heating energy demand of new buildings and renovations, (data source: [OIB 2007a])

### Contents and calculation method

In Austria the contents of the energy pass for a residential building are different from the contents of the energy pass for a non-residential building. Fig. 22 shows an example for an energy pass for a residential building.

Fig. 22: example of an Austrian Energy Pass for residential buildings [OIB 2007a]

The calculation method (asset rating) for the energy performance of residential buildings includes the useful energy following the calculation procedure of the European standard EN ISO 13790 for heating. The algorithm for heat production and delivery was developed by the OIB (Austrian Institute of Construction Engineering) following CEN Standards [OIB 2007b]. The calculation method for non-residential buildings is set up following the European standard EN ISO 13790 for the useful energy for space heating and cooling and using parts of the German standard DIN 18599 for the useful energy of ventilation air, cold production and distribution, lighting, and standardized user behaviour adapted to the Austrian situation [OIB 2007b].

### Legal framework concerning residential buildings

*These aspects have been studied before by Wolfgang Streicher and were published in the book "Energy for sustainable development. Research papers of Czech-Austrian Energy Expert Group." in 2005 [Janouch & Schleicher 2005]:*

"The Austrian legal framework for residential buildings distinguishes three different laws according to the different forms of ownership:

- rent law ("Mietrechtsgesetz", MRG)
- co-operative housing law („Wohnungsgemeinnützigkeitsgesetz", WGG)
- condominium law ("Wohnungseigentumsgesetz", WEG)

- The **rent law** refers to about 30 % of all households. It is applied mainly for the multi-family building stock, which has been constructed before the Second World War and to multi-family buildings rented out by municipalities or by companies. The renter is responsible for the maintenance of public parts of the building (facade, roof, stair-well, etc.), in specific cases for maintenance of flats (but only for heavy damages), maintenance of common appliances, renovation measures based on decisions of public authorities, installation of technical feasible measures that reduce the energy demand of the building (pay-back period of ten years), useful improvements of the building, if there is enough rent reserve available. To finance these kinds of measures the landlord has to use at first the rent reserves from the last ten years (i.e. the reserves that remain from rent revenues after subtracting all expenses for maintenance in the given time-span). If these reserves are not sufficient he has to use the expected rent reserves over the coming ten years. Finally – if both financing resources are not enough – the landlord is allowed to apply for an increase of the rent (§18 MRG). This application has to be approved by the so-called "Schlichtungsstelle", which is an administration for the settlement of disputes outside the court system.
- The **co-operative housing law** is quite comparable to the tenants' law. However there is one main issue that distinguishes these two laws with respect to building renovation activities. Additionally to the ordinary rent, the housing co-operative is allowed to charge a so-called maintenance and improvement fee. The level of this fee has an upper limit which is defined by law and which depends mainly on the construction period of the building. For buildings that have been built more than 20 years ago the upper limit is € 1.32 per sqm and month, of which € 0.33 are reserved for ordinary running maintenance. The rest can be used for improvement resp. comprehensive building renovation measures.
- The **condominium law** refers to multi-family buildings in which the dwellings are owner-occupied. This law regulates how public parts of the building have to be administered by the association of the owners. The following issues concerning building renovation have to be approved by the majority of owners: the monthly payments to the maintenance reserve and the raising of a loan for renovation activities in the case that the reserves are not sufficient to cover investment costs. For any kind of improvement measures (i.e. investment that goes beyond the pure maintenance of the building) an unanimous decision of the owners is necessary."

### Legal obstacles

Those different laws have big influence on the possibility to perform thermal retrofitting in the sector of residential buildings. There are several obstacles which should be diminished to create a legal framework which stimulates renovation of buildings: [Michlmair et al. 2007]

- **rent law (MRG):**  
*The rent law defines heat-insulating measures as maintenance-works and therefore as a duty of the landlord. Costs of those measures can be recouped by raising the rent of existing tenancy-agreements.*



Despite this duty to perform maintenance-works there are actually some barriers to increase the renovation rate:

**undefined criteria to raise house rent**

In many cases it is necessary to get a decision of an arbitration board or the court of justice to raise house rent. Installation of additional heat-insulation is only possible if the arising costs are cost-effective in comparison with the expected effects. This economic efficiency is not exactly defined yet.

**speculative reasons**

Especially houses, which are completely worn out, can provide extremely high returns to the landlord (e.g. if they are rent to foreign nationals). Furthermore it is possible that houses on inner-city real estates effect higher returns when they are not renovated. Obligatory thermal renovations should improve this situation.

- **co-operative housing law (WGG):**  
The general regulations concerning co-operative housing to install heat-insulating measures is better than in the sector of private rental. A reason for this improved situation is the appropriation of payments for preservation and improvement.
  
- **condominium law (WEG):**  
The condominium law treats thermal renovations the same way as preservation works. It is necessary to obtain a majority of owners to start a renovation. The following facts prevent a raise of the thermal renovation rate on the condominium housing sector:

**subletting of flats**

Many owners let their dwellings and do not pay much attention in their maintenance duty because they are not concerned directly.

**reduction of the current costs**

Owners want to keep current costs as low as possible and do not pay more money to funds for preservation and improvement. Therefore it is not possible to perform cost-expensive heat-insulating works but only maintenance works.

**Possible measures**

Those three laws are very important for the renovation rate of only 1 % p.a in Austria. It is up to the government to adapt those laws to create a framework, which stimulates retrofitting of buildings instead of slowing it down. The following improvements could raise the level of thermal renovation to more than the current value:

- Effective and obligatory regulations to provide renovations to a certain standard (e.g. energy-efficiency) should be implemented. This could be accomplished with the implementation of the EPBD in Austria.
  
- Compulsory renovations depending on the level of energy demand for heating as well as binding reserves for thermal renovations could be also a way to improve the rate of thermal retrofit.
  
- Especially in the sector of subsidized housing thermal renovations are not possible if the reduction of the operating costs is lower than the necessary capital for the intalled heat-insulation. This should be changed.

### **Rebound-effects**

*All aspects of Rebound-Effects have been studied by Peter Biermayr, Ernst Schriefl, Bernhard Baumann, et al. within the Austrian program on Technologies for Sustainable Development in the project "Measures for Minimisation of Rebound-Effects Concerning Residential Building Renovation (MARES)" [Biermayr et al. 2005]. The following text is the English abstract of the final report of this project:*

"Redevelopment of buildings is seen as an effective measure to reach national and international agreements for climate protection. But energy savings of realized redevelopment projects often do not reach the expected calculated values. Under different side conditions there are no savings observable at all and in extreme situations, energy consumption for space heating increases after redevelopment. This phenomenon has been discussed since 1980 in scientific literature, but a comprehensive study or a detailed quantitative investigation of these so called "Rebound-effects" is still missing. Essential obstacles for a systematic investigation are insufficient data on the one hand and a missing interdisciplinary approach considering technical-structural and socio-economic aspects on the other hand. (...)

The results of the study emphasize the importance of rebound-effects in the area of building redevelopment and corroborate the findings of national and international literature. Rebound-effects can be subdivided into economical, structural and technical effects. Economic effects are caused by decreasing costs of thermal comfort, structural effects are based on heating system changes or an increasing living area, and technical effects are caused by a missing adjustment of the heating system to the new building parameters. The quantification of rebound-effects shows, that these effects rise, when the condition of building before redevelopment is worse and the redevelopment is more comprehensive. Therefore, small redevelopment actions on by and large good buildings (100 kWh/sqm<sub>GFA</sub>.a) lead to small rebound-effects about 5 %. Redvelopments on average buildings (200 kWh/sqm<sub>GFA</sub>.a) cause rebound-effects up to 20 % and redevelopment of buildings in bad condition (400 kWh/sqm<sub>GFA</sub>.a) show typical rebound effects up to 50 % and more.

The investigation shows that possibilities for the reduction of rebound-effects are restricted, if increasing comfort of consumers is to be provided. But there is still the possibility to reduce e.g. technical rebound-effects by the optimisation of heating system and to restrict consumers' scope of comfort to a meaningful measure by intelligent regulation systems. Furthermore energy policy measures like redevelopment subsidies can influence structural rebound-effects e.g. by a limitation of living area increase in the coherence with building redevelopment."

[Biermayr et al. 2005]

### **Subsidies**

Especially subsidies can redirect future standards for building. All provinces spend a lot of money in the sector of subsidized buildings. Therefore it should be possible to claim specific standards.

Following this argumentation the Austrian Ministry of Environment (BMLFUW) is implementing – based on the financial compensation of the federal state and the Federal provinces – an agreement concerning "measures in the building sector with the objective to reduce emissions of greenhouse gases" ("Maßnahmen im Gebäudesektor zum Zweck der Reduktion des Ausstoßes an Treibhausgasen").

The law has passed the parliament and came into force by July 2009. This agreement defines requirements for particular aspects. According to this law future subsidies should be focused on renovation of buildings: [Austrian Republic 2008]

- Further development of technical standards: Based on the technical and energetic standards of the harmonized body of rules' directive 6 the future upper limits for the heating energy demand shall be tightened. Split up into two types of residential buildings (depending on their size) upper limits for new buildings and renovation of buildings will be defined. These limits must be fulfilled to get subsidies.

(in kWh/sqm <sub>GFA</sub> ·a)	detached houses	apartment buildings
new buildings	36	20
renovations	75	33

Fig. 23: Future upper limits for heating energy demand (useful energy) in [kWh/sqm<sub>GFA</sub>·a] for two types of residential buildings to be implemented by January 2012. [Austrian Republic 2008]

- Use of renewable energy sources for heating and cooling: As a requirement to get subsidies it will be necessary to use renewable energy sources like solar heat, geothermal energy (seasonal performance factor > 4.0), biomass or district heating networks (co-generation of heat and power or more than 80 % renewable energy sources).
- Specifications concerning energy for public buildings: Both the Federal provinces and the federal state will have to stick to tighter limits for their new buildings and renovations concerning energy. The requirements that have to be fulfilled by future public buildings will be a much stronger than the existing building codes.
- Supporting and accompanying measures of the federal state: The federal state will spend additional subsidies for non-residential buildings, especially for their renovation. Furthermore there will be an improvement of the legal framework for housing to uprise the future thermal renovation rate and an improvement of the curricula of universities and technical schools to include these aspects into education.

Concerning detached houses politicians did not follow experts' recommendations: There will be subsidies for detached houses – which are on the one hand the Austrian's most popular way of living but have on the other hand due to their small size very poor energy indexes – in the future.

### Allocation of heating costs

The way of allocating heating costs to occupants of apartments in multi-family houses is vitally important for the energy use of the whole building. If people are forced to pay for their use of energy they mostly try to reduce the waste of energy (and money) as far as possible. Some Austrian studies of the early eighties point out a reduction between 7 % and 11 % of the energy use for heating purposes in case of usage-bound allocation of heating costs compared to payment of lump sums [Hofbauer & Lucny 1985], [Fantl 1977].

Regarding this reduction of energy waste Austrian legislation implemented a federal law on usage-bound allocation of costs for heating and domestic hot water in 1992. Since then for every building with more than three different facilities allocation of heating costs has to be done usage-bound.

### The influence of district heating networks

In Austria about 16 % of the energy use for heating, cooling and warm water is provided by district heating networks [Statistics Austria 2008]. Energy sources of those networks are on the one hand fossil fuels like oil, gas or coal but on the other hand in the last ten years many networks with renewables as energy carriers were installed. In 2004 more than 800 biomass district heating networks with a total power of about 1 GW were supplying heat and domestic hot water. Beside biomass (often combined with solar thermal collectors) especially biogas and waste incineration plants provide renewable energy for district heating networks.

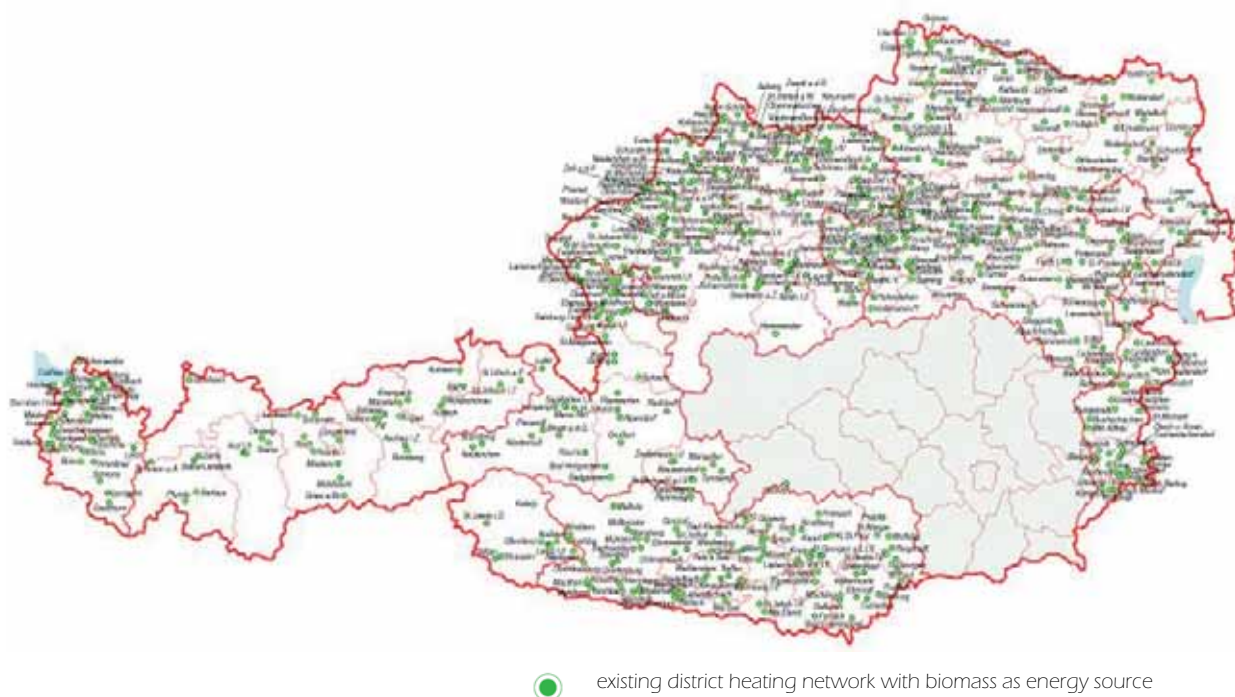

Fig. 24: District heating networks with biomass as energy source in Austria (except Styria, see Fig. 25). (data from December 2003; source: [LEV 2008a])

Especially in the province of Styria district heating networks with renewable energy sources are widely used for heating purposes. 25 % of the totally installed power based on biomass throughout Austria is installed in Styria. There are three types of networks mainly used:

- conventional district heating networks: provide energy for larger areas – e.g. for parts of larger cities, smaller towns, some villages
- micro networks: provide energy for a group of houses
- supply of single objects: provide energy for industrial objects

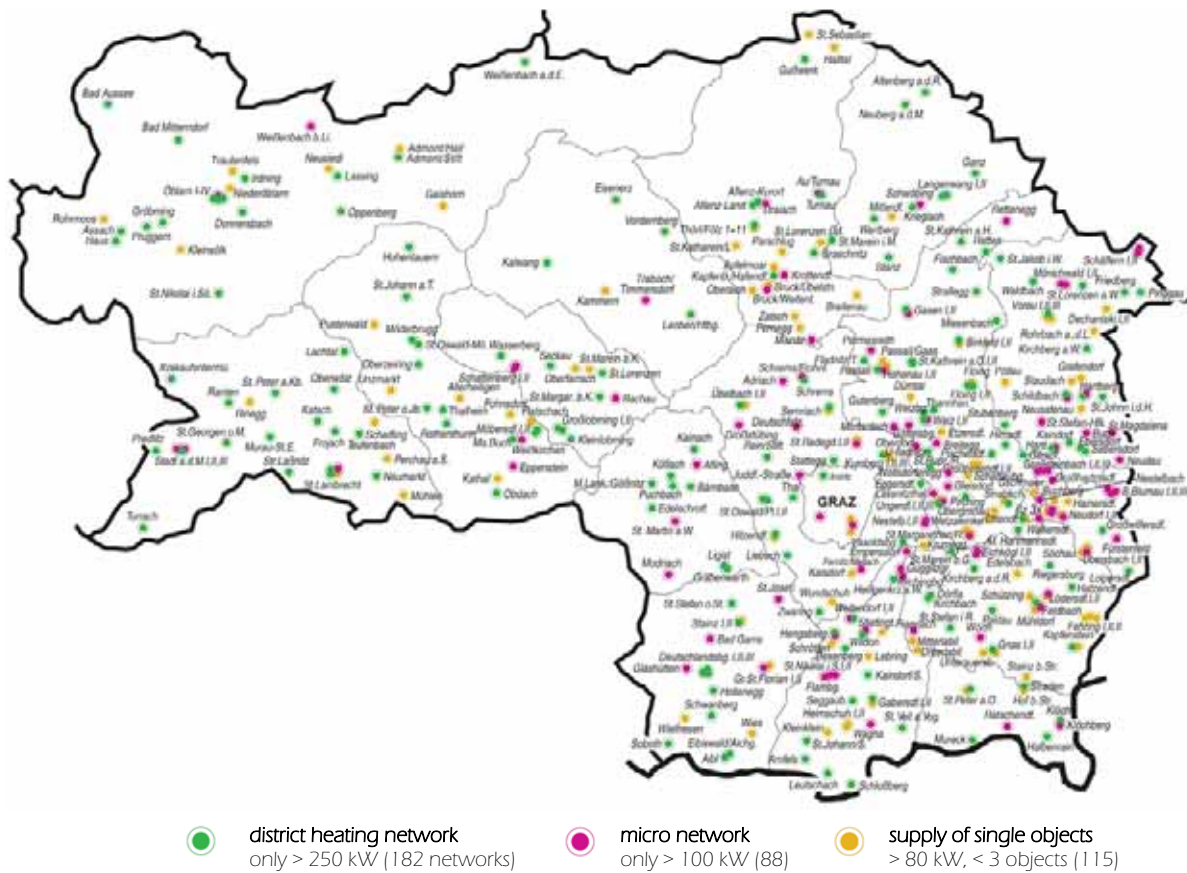

Fig. 25: District heating networks with biomass as energy source in Styria. (data from January 2007; source: [LEV 2008b])

### District heating networks and renovation

More and more district heating networks were erected in the last few years. The advantages are obvious: The user doesn't have to care about maintaining of the boiler and storage and ordering of the heating material, the boilers are working more efficient because of its bigger size and the use of renewable energy sources is getting more common. But there are also disadvantages which mainly focus on the technical side of such networks: Errection and maintainance of the distribution network are very expensive and therefore it is necessary to reach a high number of consumers with as little network as possible. Thus it should be given a high density of consumers in the supplied area. The costs for installation of the network and the boilers etc. are recouped from the consumers by two price elements:

- fixed costs: This standing charge tariff is dependent from the heating load of the building that has to be covered
- operational costs: The variable costs depend on the amount of energy that is delivered to the consumer.

In case of renovation of a building two results are important for the operator of a district heating network: A thermal renovation results a reduced heating load of the building and a reduced heating energy demand. Hence the operator faces reduced incomes – either fixed and variable costs for the consumer will be lower after renovation – and unchanged expenses for maintainance of the network. Therefore thermal renovations of buildings which are connected to district heating

networks often end up in a conflict. On the one hand operators have to raise charge because of their reduced incomes and on the other hand consumers do thermal renovations because of the conceivable reduction of the heating costs. By now there is no suitable solution for this problem.

### Service-life of insulation materials

Basically a wall construction consists of different layers which have to fulfil four main purposes [Pech & Kolbitsch 2005]:

- layer for protection against weather
- load-transferring layer
- layer for thermal insulation
- visible inner layer

Fig. 26 shows how those main purposes are fulfilled by different types of wall constructions:

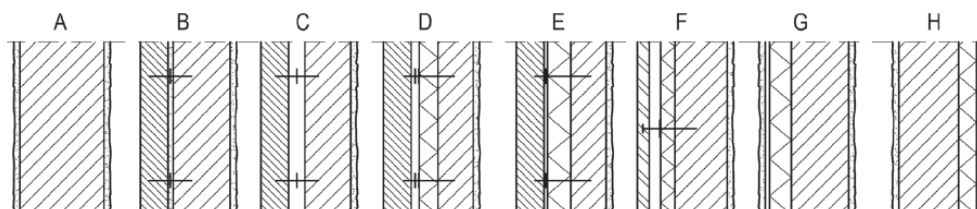

- A) *homogeneous wall*
- B) *double-leaf wall without air layer*
- C) *double-leaf wall with air layer*
- D) *double-leaf wall with air layer and thermal insulation*
- E) *double-leaf wall with core insulation*
- F) *double-leaf wall with air layer and thermal insulation, cladding ventilated at rear*
- G) *wall with external thermal insulation composite system*
- H) *single-leaf wall with internal insulation*

Fig. 26: Types of wall constructions. (figure from [Pech & Kolbitsch 2005])

The construction-type with the best cost-benefit ratio for fulfilling requirements of building physics, statics and architecture is type G – a wall with an external thermal insulation composite system. Because of comparatively low costs and well-known building details this construction-type is widely used in Austria - especially for application along with renovation measures. But beside those mentioned advantages external thermal insulation composite systems (ETICS) have also some disadvantages – in particular concerning ecological aspects [Riedel et al. 2007]:

- insulation materials: The materials used as insulation are mainly expanded and extruded polystyrene (EPS and XPS), mineral rock wool and mineral-bound wood wool. The production-process of all of these materials requires lots of energy and especially the synthetic-organic materials XPS and EPS are directly dependent on availability of crude oil. According to [Riedel et al. 2007] and [Michlmair 2008] all studies concerning environmental life cycle assessment of ETICS-systems result in ecological payback periods (energy) shorter than two years. Besides this also other ecological impacts of the production stage are to be accepted compared to the benefits due to the reduction of thermal losses through the wall.



- service life: Compared to other wall constructions the service life of external thermal insulation composite systems is reasonably short. It has to be classified “middle” with an average service life of 16 to 35 years.
- separability: ETICS-systems are composite systems of several different materials. In case of EPS as insulation material, mineral mortar, synthetic insulation material (EPS), metal anchors, reinforcement consisting of non-organic or organic fibres, and mineral or synthetic plaster are combined and adhesive bounded to the wall. Thus it is not possible to separate and substitute single layers individually in case of failure.
- recyclability: As a result of the composite structure and its adhesive bounding to the wall of ETICS it is not feasible to bring it back to recycling. Especially the combination of synthetic, organic (wood in case of mineral-bound wood wool) and mineral materials makes any kind of recycling nearly impossible. Reacting to these circumstances insulation industry developed new materials consisting of mineral foam. Due to this innovation available since 2005 it is possible to recycle ETICS-systems which are completely mineral-based.

Summing up external thermal insulation composite systems are cheap and technical approved insulation-systems well applicable for renovations. Disadvantages concerning choice of materials, duration of service life, separability and recyclability cause problems which are not solved by now. Future ETICS-systems have to be recyclable and easier to separate. [Riedel et al. 2007]

## 1.4 Recommendations



Regarding to the composition of the Austrian building stock two groups of buildings should be mainly focused in future renovation activities: Firstly it is necessary to improve condition of both detached and apartment buildings erected in the time period 1945 to 1961. A vast part of heating energy has to be spent for conditioning of those buildings. Secondly and even more important it is essential to rein the growing number of detached houses in Austria. Although this is the Austrians favored kind of living those buildings emit an enormous amount of CO<sub>2</sub>.

Besides the ecological advantages some studies showed up that an improvement of the renovation rate also means positive influence on macroeconomics: Because of a rising employment the economical benefits of increased renovation measures is beyond their overall costs. Therefore it is both economic and ecologic reasonable to spend more money on thermal renovations.

Despite this there are still some hindrances which should be diminished in order to advance the renovation rate. Especially legal aspects – mainly concerning rent law, co-operative housing law and condominium law – often cause problems in connection with renovations of buildings. Those laws should be modified in order to improve the surrounding conditions for good thermal renovations of buildings in the future.

## 1.5 References

AMT DER STEIERMÄRKISCHEN LANDESREGIERUNG (2005): *Vereinbarung gemäß Art. 15a B-VG über die Harmonisierung bautechnischer Vorschriften (Agreement according to article 15a of the Austrian Constitution concerning the harmonisation of building codes)*, 2.5.2005.

AUSTRIAN ENERGY AGENCY & AUSTRIAN FEDERAL ENVIRONMENT AGENCY (2005): *Evaluierungsbericht zur Klimastrategie Österreichs. 22. Juli 2005. (Evaluation-report of the Austrian Climate Strategy)*. Vienna, 2005.

AUSTRIAN FEDERAL ECONOMIC CHAMBER (ed.) (2006): *Innovation & Klima. Innovative Klimastrategien für die österreichische Wirtschaft. (Innovation & Climate. Innovative climate strategies for the Austrian economy.)* Vienna, 2006.

AUSTRIAN FEDERAL ENVIRONMENT AGENCY (2007): *Kyoto-Fortschrittsbericht Österreich 1990–2005. Datenstand 2007. (Kyoto-progress-report Austria, 1990-2005. Data from 2007.)* Vienna, 2007.

AUSTRIAN REPUBLIC (2006): 137. *Federal Law Gazette of the Austrian Republic: Energieausweis-Vorlage-Gesetz – EAVG (idF v. 3.8.2006). (Law on submission of energy passes – as amended on 3.8.2006)*.

AUSTRIAN REPUBLIC (2008): *Maßnahmen im Gebäudesektor zum Zweck der Reduktion des Ausstoßes an Treibhausgasen (Measures in the building sector with the objective to reduce emissions of greenhouse gases) (draft worked out by Federal Ministry of Agriculture, Forestry, Environment and Water Management)*. Online under: <http://wko.at/up/enet/stellung/Art%2015a-VereinbarungTreibhausgaseentw.pdf> [version: 2008-12-08]

BIERMAYR, P. ET AL. (2005): *Maßnahmen zur Minimierung von Reboundeffekten bei der Sanierung von Wohngebäuden (MARESI) (Measures for Minimisation of Rebound-Effects Concerning Residential Building Renovation)* / Institute of Energy Economics, Vienna University of Technology. Vienna, 2005. – *Berichte aus Energie und Umweltforschung* 6/2005

EIPER, T. & STREICHER, W. (2006): *The state of the Implementation of the European Energy Performance of Buildings Directive (EPBD) in Austria.* / Graz University of Technology, Institut of Thermal Engineering. Graz, 2006. – project report

EUROPEAN PARLIAMENT (2003): *Directive 2002/91/EC of the European Parliament and of the Council of 16 December 2002 on the energy performance of buildings*. In: *Official Journal of the European Communities* Nr. L 001, 4.1.2003.

EUROPEAN PARLIAMENT (1989): *Council Directive of 21 December 1988 on the approximation of laws, regulations and administrative provisions of the Member States relating to construction products (89/106/EEC)*. In: *Official Journal of the European Communities* Nr. L 40, 11.2.1989



FANTL, K. (1977): *Einflüsse der Heizkostenverrechnung auf den Energieverbrauch (Influence of allocation of heating costs on energy use)*. Vienna, 1977 – project report. Research project ordered by the Austrian Federal Ministry for trade, business and industry.

FEDERAL MINISTRY OF AGRICULTURE, FORESTRY, ENVIRONMENT AND WATER MANAGEMENT (BMLFUW) (ed.) (2002): *Strategie Österreichs zur Erreichung des Kyoto-Ziels. Klimastrategie 2008/2012. Vom Ministerrat angenommen am 18. Juni 2002. (Austrian strategy to achieve the Kyoto-goal. Climate Strategy 2008/2012. Resolution passed by Austrian Council of Ministers on June 18<sup>th</sup>.)* Vienna, 2002.

FEDERAL MINISTRY OF AGRICULTURE, FORESTRY, ENVIRONMENT AND WATER MANAGEMENT (BMLFUW) (ed.) (2007): *Anpassung der Klimastrategie Österreichs zur Erreichung des Kyoto-Ziels 2008-2012. Vom Ministerrat am 21. März 2007 beschlossen. (Adaptation of the Austrian Climate Strategy to achieve the Kyoto-goal 2008-2012. Resolution passed by Austrian Council of Ministers on March 21<sup>st</sup>.)* Vienna, 2007.

HOFBAUER, E. & LUCNY, P. (1985): *Verbrauchsabhängige Waermekostenverrechnung am Wohnungssektor. Auswirkungen der verbrauchsabhängigen Waermeverrechnung auf den Energieverbrauch der Haushalte. (Usage-bound allocation of heating costs at the housing sector) / Oesterreichischer Energiekonsumenten-Verband (Ö.E.K.V.), Vienna: 1985 – project report.*

HÜTTLER, W.; LANG, G.; LEUTGÖB, K.; TRETTER, H., 2003: *FRAMES – Framework Innovations for Building Renovation, DRAFT country report Austria. A SAVE-project co-ordinated by E.V.A. (Austrian Energy Agency)*. Vienna, 2003

JANOUGH, F.; SCHLEICHER, S. (eds.) (2005): *CZ-AT EEG 2005. Energy for sustainable development. Research papers of Czech-Austrian Energy Expert Group*. Prague, 2005

JUNGMEIER ET AL. (1996): *GEMIS-Österreich – Emissionsfaktoren und energietechnische Parameter im Prozeßkettenbereich Endenergie-Nutzenergie. (GEMIS-Austria – Emission factors and energetic parameters in process chain final energy - useful energy)*. / Institute of Energy Research, Joanneum Research. Graz, 1996. – project report

LANDESENERGIEVEREIN STEIERMARK – LEV (2008a): *Biomasse – Nah/Fernwärme-Netze in Österreich. Stand: Dezember 2003. (Biomass – District heating networks in Austria. Version: December 2003.)* Online under: <ftp://ftp.lev.at/BMKarteOE2003.pdf> [version: 2008-12-08]

LANDESENERGIEVEREIN STEIERMARK – LEV (2008b): *Biomasse – Wärmenetze in der Steiermark. Stand: Januar 2007. (Biomass – District heating networks in Styria. Version: January 2007.)* Online under URL: [ftp://ftp.lev.at/Biomnetze\\_StmkKarte2007.pdf](ftp://ftp.lev.at/Biomnetze_StmkKarte2007.pdf) [version: 2008-12-08]

MICHLMAIR, M. (2008): *Ökobilanzierung von Wohnhausanlagen. Vergleich der lebenszyklusweiten Umweltwirkungen von Wohnhausanlagen verschiedener Bauweise (Life cycle analysis of residential buildings. Comparison of environmental impacts of apartment buildings along their life cycle.)*. Graz, Graz University of Technology, diploma thesis, 2008.

MICHLMAIR, M. ET AL. (2007): *Thermal Retrofit of buildings in the Czech Republic and Austria*. In: *Czech-Austrian Energy Expert Group, CZ-AT EEG Research Paper Series*. Prague, Dezember 2007.

OIB (ed.) (2007a): *OIB-Richtlinie 6. Energieeinsparung und Wärmeschutz. (OIB-guideline 6. Energy conservation and heat insulation.)* / Österreichisches Institut für Bautechnik (Austrian Institute of Construction Engineering). Vienna, 2007.

OIB (ed.) (2007b): *Leitfaden „Energietechnisches Verhalten von Gebäuden“.* (Guideline “Energy performance of buildings”.) / Österreichisches Institut für Bautechnik (Austrian Institute of Construction Engineering). Vienna, 2007.

PECH, A. & KOLBITSCH, A. (2005): *Baukonstruktionen Band 4: Wände*. Vienna: Springer-Verlag, 2005.

RIEDEL, W.; OBERHAUS, H.; FRÖSSEL, F.; HAEGELE, W. (2007): *Wärmedämmverbundsysteme. Von der Thermohaut bis zur transparenten Wärmedämmung.* (External thermal insulation composite systems: From „thermo-skins“ to transparent heat insulation.) Stuttgart: Fraunhofer IRB Verlag, 2007.

STATISTICS AUSTRIA (ed.) (2004): *Gebäude- und Wohnungszählung, Hauptergebnisse Österreich.* (Census of buildings and dwellings, main results Austria.) Vienna: Verlag Österreich, 2004.

STATISTICS AUSTRIA (ed.) (2006): *Statistisches Jahrbuch Österreichs 2006.* (Statistical annual of Austria 2006.) Vienna: Verlag Österreich, 2006.

STATISTICS AUSTRIA (ed.) (2007): *Statistisches Jahrbuch Österreichs 2007.* (Statistical annual of Austria 2007.) Vienna: Verlag Österreich, 2007.

STATISTICS AUSTRIA (ed.) (2008): *Statistisches Jahrbuch Österreichs 2008.* (Statistical annual of Austria 2008.) Vienna: Verlag Österreich, 2007.

STATISTICS AUSTRIA (ed.) (2009): *Energiebilanzen für Österreich und die Bundesländer 1970 (1988)-2007.* (Energy Balances for Austria and its Laender 1970 (1988)-2007). Online under URL: [http://www.statistik.at/web\\_de/statistiken/energie\\_und\\_umwelt/energie/energiebilanzen/dokumentationen.html](http://www.statistik.at/web_de/statistiken/energie_und_umwelt/energie/energiebilanzen/dokumentationen.html) [version: 2009-08-25]

## Anhang - Beiträge zu Subtask B

zum Bericht

### Die österreichische Beteiligung am IEA SHC TASK 37

#### Advanced Housing Renovation with Solar & Conservation

#### Inhalt

1.1	Brochure Enhancement Mautern .....	2
1.2	Brochure Housing Purkersdorf .....	4
1.3	Brochure Apartment building Kierling .....	7
1.4	Brochure Enhancement house StValentin .....	10
1.5	Brochure 5-storey apartment house Linz .....	12
1.6	Brochure Singlefamily house Pettenbach .....	15
1.7	Brochure Historic building Irdning .....	18
1.8	Brochure Single-family house St.Martin .....	21
1.9	Brochure Single-family house Kufstein .....	23
1.10	Brochure Attic conversion Innsbruck .....	25
1.11	Brochure Old peoples home Landeck .....	28
1.12	Brochure Apartmentbuildings Dornbirn .....	30

Projekt im Rahmen der österreichischen Beteiligung am  
Energietechnologieprogramm der IEA. Im Auftrag des  
Bundesministeriums für Verkehr Innovation und Technologie.

Zusammenstellung T. Mach (Institut für Wärmetechnik, TU Graz) im August 2010



## 1.1 Brochure Enhancement Mautern

**PROJECT SUMMARY**  
Renovation of a detached house, built in the 1950ies, with vertical enhancement for a second housing unit and a new staircase.

**SPECIAL FEATURES**  
- components of a Passive House in the first floor  
- central ventilation system with heat recovery  
- air/air heat pump

**ARCHITECT**  
Architekt Dipl. Ing. FH  
T. Abendroth

**OWNER**  
Fam. T.  
Private



### Enhancement in Mautern - AT



IEA – SHC Task 37  
Advanced Housing Renovation with Solar & Conservation



#### BACKGROUND

The single family house in Mautern near Vienna was built in the fifties with a central gas heating system, a central preparation of domestic hot water by electricity and a typical building envelope with a space heat demand of 332 kWh/(m<sup>2</sup>a).

After renovation and enlargement of a new storey built with wooden framework walls in 2004, the whole building complies to low energy requirements and achieves 42 kWh/(m<sup>2</sup>a) space heating demand.

#### OBJECTIVES OF THE RENOVATION

- doubling of the living space
- reduction of the heating costs to a minimum
- high degree of pre-fabrication
- to comply with low energy requirements in the new storey
- conservation of the garden area
- renovation with least annoyance of residents
- to construct an economic building

#### SUMMARY OF THE RENOVATION

- insulation of the building envelope: roof (400 mm), façade (300 mm) basement ceiling (180 mm)
- triple glazed windows in the upper floor
- enhancement of the ground floor
- utilization of prefabricated wall units (first floor)
- new balconies in the first floor
- addition of an external staircase
- one new window in the ground floor
- mechanical ventilation system with heat recovery and air/air heat pump in the first floor

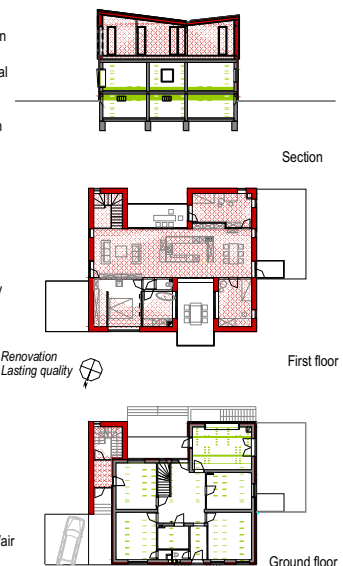



**CONSTRUCTION**

**Roof construction** *U-value: 0.112 W/(m<sup>2</sup>·K)*  
(interior to exterior)

plasterboard	15 mm
air space	36 mm
OSB airtight	16 mm
cellulose insulation	400 mm
softboard	16 mm
air space	80 mm
boards, roof covering metal	24 mm
<b>Total</b>	<b>587 mm</b>

**Wall construction** *U-value: 0.143 W/(m<sup>2</sup>·K)*  
(interior to exterior)

plasterboard	15 mm
air space	36 mm
OSB airtight	16 mm
cellulose insulation	300 mm
softboard	16 mm
air space	50 mm
lathing	25 mm
boarding	25 mm
<b>Total</b>	<b>483 mm</b>

**Basement ceiling** *U-value: 0.194 W/(m<sup>2</sup>·K)*  
(top down)

slab	30 mm
floor screed	60 mm
insulation polystyrene	180 mm
concrete floor	160 mm
<b>Total</b>	<b>430 mm</b>

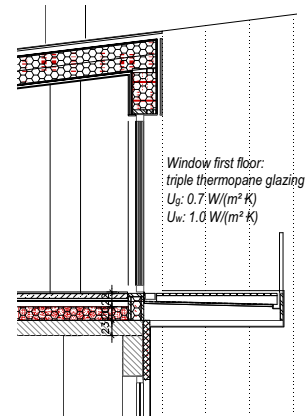

Window section – south terrace

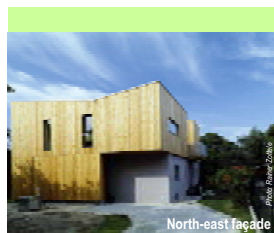

**Summary of U-values W/(m<sup>2</sup>·K)**

	Before	After
Roof	1.3	0.11
Walls	1.5	0.14
Basement ceiling	0.9	0.19
Windows	ca. 1.4	1.00

**BUILDING SERVICES**

The building will meet the requirements of a low energy requirement by means of high insulation of the top floor, reductions of thermal bridges, glazing with Passive House windows in the first floor and an airtight envelope.  
A new central ventilation system with heat recovery (efficiency 85%) and air/air heat pump is installed in the new storey. The preheating of the cold air is realized with a ground-air heat exchanger.  
The new floor heating in the upper floor and the radiators in the ground floor are operating with the central gas heating. The domestic hot water is heated by the central gas heating.

**RENEWABLE ENERGY USE**

Using an air/air heat pump with preheating of the cold air with a ground-air heat exchanger.

**ENERGY PERFORMANCE**

Space + water heating (primary energy)\*  
Before: 493 kWh/(m<sup>2</sup>·a)  
After: 83.1 kWh/(m<sup>2</sup>·a)  
Reduction: 83% (existing gas heating)

\*according to OIB Richtlinie 6

**INFORMATION SOURCES**

Architekt Thomas Abendroth  
Linke Wienzeile 178/Stiege 2./ 5 St.  
1060 Wien  
www.abendroth.at

**Brochure authors**

S. Grünewald, S. Rottensteiner

**Contact**

Thomas Mach  
thomas.mach@tugraz.at



## 1.2 Brochure Housing Purkersdorf

**PROJECT SUMMARY**  
Renovation of a 19th century villa with four flats and new construction of ten Passive House buildings on the site.

**SPECIAL FEATURES**  
- ventilation system with heat recovery in each apartment  
- 60 m<sup>2</sup> solar panels for DHW and space heating  
- reconstruction of the original façade

**ARCHITECT**  
Arch. Georg W. Reinberg  
www.reinberg.net

**OWNER**  
Aufbauwerk der Österreichischen Jungarbeiterbewegung  
Co-operative



### Housing in Purkersdorf - AT



IEA – SHC Task 37  
Advanced Housing Renovation with Solar & Conservation



#### BACKGROUND

The massive exterior walls of this three-storey 19th century villa were not insulated, with the original windows still in place. The space heating was supplied by decentral located wood fired tiled stoves. The domestic hot water was prepared decentrally by electricity and the building had a space heating demand of 180 kWh/(m<sup>2</sup>a). After the renovation 2009 the building almost complies with Passive House standards and achieves 15 kWh/(m<sup>2</sup>a) space heat demand. The building activity was sponsored by the federal state of Lower Austria.

#### OBJECTIVES OF THE RENOVATION

- reduction of the heating costs to a minimum
- ecological renovation with renewable resources
- optimized building performance
- to comply with low energy requirements
- conservation of the outward appearance of the villa

#### SUMMARY OF THE RENOVATION

- Insulation of the building envelope: roof (300 mm), façade (260 mm) basement ceiling (130 mm)
- renovation of the old windows to windows meeting Passive House standards
- reconstruction of roof and loggia
- construction of four flats
- decentral ventilation system with heat recovery in each apartment
- solar panels, solar combisystem
- biomass heating plant
- new electrical and sanitary installations

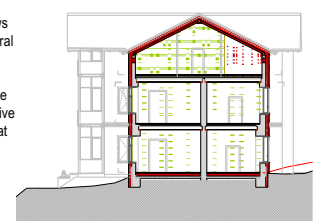

Section



Villa - ground floor

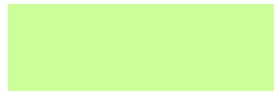

Detached house - section

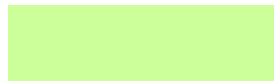

**CONSTRUCTION**

**Roof construction** *U-value: 0.113 W/(m<sup>2</sup>·K)*  
(interior to exterior)

laminated wood	146 mm
mineral wool insulation	300 mm
hard board	10 mm
air space	50 mm
lathing	30 mm
fibrated cement board	10 mm
<b>Total</b>	<b>546 mm</b>

**Wall construction** *U-value: 0.121 W/(m<sup>2</sup>·K)*  
(interior to exterior)

lime plaster	30 mm
solid brick	600 mm
expanded polystyrene	260 mm
plaster	15 mm
<b>Total</b>	<b>905 mm</b>

**Basement ceiling** *U-value: 0.251 W/(m<sup>2</sup>·K)*  
(top down)

parquet	15 mm
counter floor	20 mm
mineral wool insulation	50 mm
concrete	50 mm
brick (existing)	100 mm
stone wool insulation	80 mm
<b>Total</b>	<b>315 mm</b>

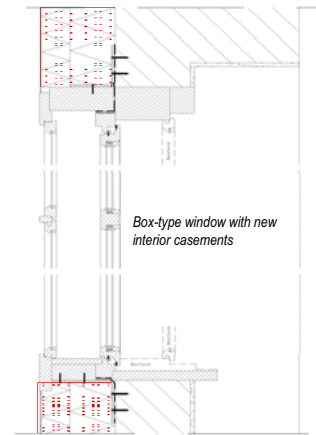

Window renovation – vertical section

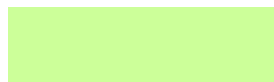

Gable moulding



New applied cornice on the insulation

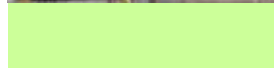

**FAÇADE DECORATION**

The lasting quality mansion gains a volume enlargement by adding a 26 cm thick insulation to the exterior walls. To preserve the proportions the roof was lifted. To the same extent the façade decorations along the edges of the buildings and along the roof were increased. However, the decorations around the windows cannot be changed because the windows of the lasting quality do not change their size and shape. As the façade decorations are a striking characteristic of the existing building, it was of high interest to reattach the decorations to the façade onto the insulation to preserve the appearance and the historic value (significance) of the building.

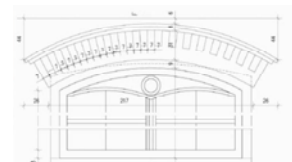

Roofing of arched window



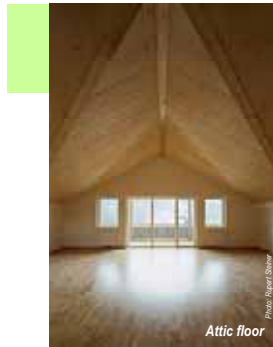

**Summary of U-values  $W/(m^2 \cdot K)$**

	New objects	Renovation
Roof construction	0.8	0.11
Walls	1.0	0.12
Basement ceiling	0.5	0.25
Windows	ca. 2.5	1.04

**BUILDING SERVICES**

The building will meet the requirements of a Passive House by means of reinforced insulation of the top floor, walls and cellar ceiling, reductions of thermal bridges and the renovation of the old box-type windows by changing the interior casements to Passive House standard windows.

A ventilation system with heat recovery (efficiency 85%) in each flat is installed. The remaining space heat demand is covered by a central biomass heating and the heat is released with low temperature heat distribution system. Domestic hot water is heated by solar panels and the remaining heat demand is provided by central biomass heating.

**RENEWABLE ENERGY USE**

The 60 m<sup>2</sup> solar panels on the south facing roof of the existing building achieve an annual solar fraction of the solar heating system of 27.7% (for DHW and space heating)

**ENERGY PERFORMANCE**

Space + water heating (primary energy)\*  
 Before: 419 kWh/(m<sup>2</sup>a)  
 After: 15.8 kWh/(m<sup>2</sup>a)  
 Reduction: 96 %

\* according to OIB Richtlinie 6

**INFORMATION SOURCES**

Architekturbüro Reinberg ZT GmbH  
 Lindengasse 39/10  
 A-1070 Wien  
 www.reinberg.net

**Brochure authors**

Architekt G. W. Reinberg  
 S. Grünewald, S. Rottensteiner

**Contact**

Thomas Mach





## 1.3 Brochure Apartment building Kierling

**PROJECT SUMMARY**  
Renovation of an apartment building built in the 1970s, with a vertical enhancement, involvement of residents and elevator installation. Will comply with Passive House standards.

**SPECIAL FEATURES**  
- central ventilation system with heat recovery  
- 98 m<sup>2</sup> solar panels for DHW preparation  
- accessible for handicapped people

**ARCHITECT**  
Arch. Georg W. Reinberg  
www.reinberg.net

**OWNER**  
BUWOG, Bauen und Wohnen GmbH  
Co-operative



### Apartment building in Kierling - AT



IEA – SHC Task 37  
Advanced Housing Renovation with Solar & Conservation



#### BACKGROUND

This four storey apartment building in Kierling near Vienna was constructed in the 1970s. The massive exterior walls, made out of Durisol brick, are not insulated, the original windows are still in place. The space heating is supplied by an electrical floor heating system. The domestic hot water is also provided decentrally by electricity and the building has a space heating demand of 79 kWh/(m<sup>2</sup>a). After the renovation and enlargement from 24 to 30 apartments it will comply with Passive House standard and will achieve 13 kWh/(m<sup>2</sup>a) space heating demand. The building project will be subsidized by the federal state of Lower Austria, a program of the federal office for old building redevelopments.

#### OBJECTIVES OF THE RENOVATION

- renovation with a least distribution of residents
- involvement of the residents in the planning
- reduction of heating costs
- optimized building performance
- access for handicapped people

#### SUMMARY OF THE RENOVATION

- 20-30 cm insulation of façade, roof 45 cm and 24 cm cellar ceiling
- windows meeting Passive House standard (triple glazing)
- glazed balconies
- handicapped access
- six additional penthouse flats
- installation of 3 elevators
- central mechanical ventilation system with heat recovery and air heating
- solar panels for domestic hot water preparation
- central biomass heating system

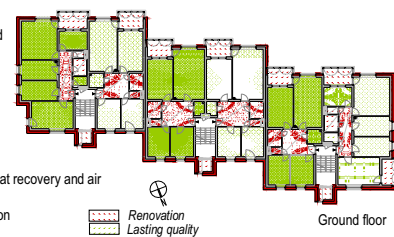
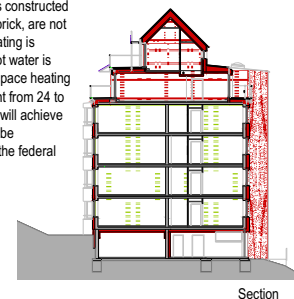

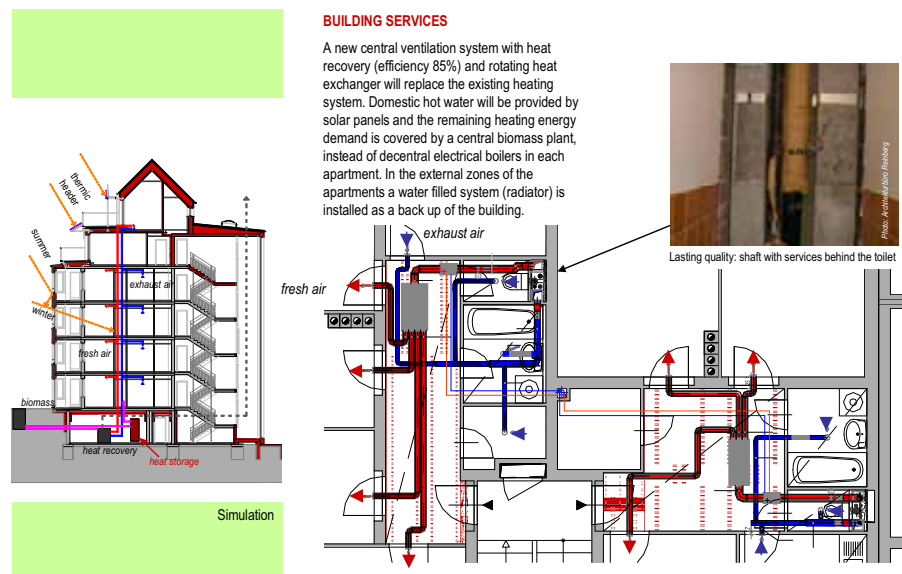
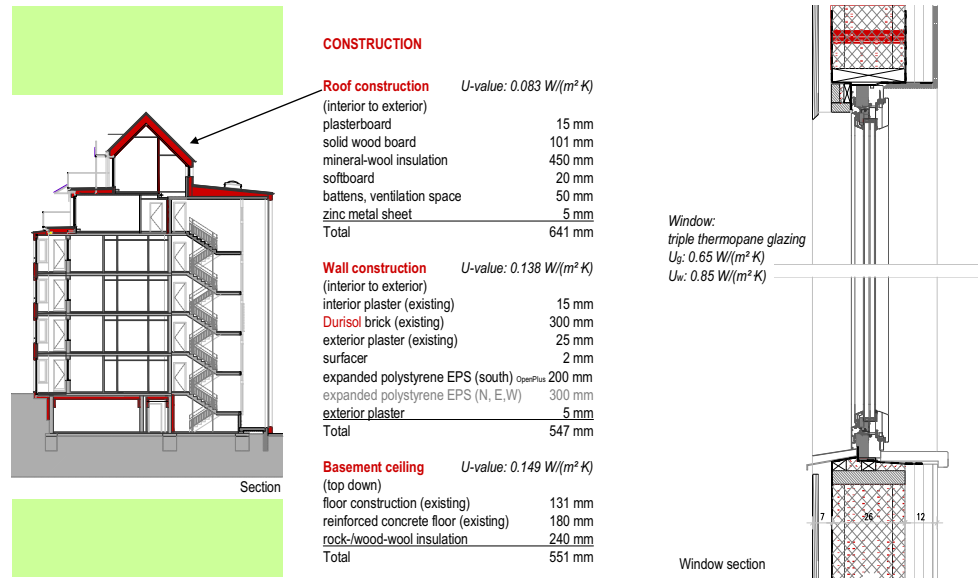

Penthouse



East façade

**Summary of U-values  $W/(m^2 \cdot K)$**

	Before	After
Roof construction	0.5	0.08
Walls	0.7	0.14
Basement ceiling	1.0	0.15
Windows	ca. 2.8	0.85

**RENEWABLE ENERGY USE**

The 98 m<sup>2</sup> solar panels on the south-facing roof will achieve an annual solar fraction of 57% for domestic hot water preparation. Photovoltaic (PV) is planned as sunscreen on the upper ceiling.

**BUILDING STATUS**

Work in process

All specifications are given without liability or warranty

**ENERGY PERFORMANCE**

Space + water heating (primary energy)\*

Before: 91 kWh/(m<sup>2</sup>a)

After: 18.9 kWh/(m<sup>2</sup>a)

Reduction: 80 %

\* according to OIB Richtlinie 6

**INFORMATION SOURCES**

[Project: Inhabitants-friendly passiv house renovation in Klosterneuburg / Kierling, 2006, bmvit, building of tomorrow](#)

Architekturbüro Reinberg ZT GmbH  
Lindengasse 39/10  
A- 1070 Wien  
[www.reinberg.net](http://www.reinberg.net)

**Brochure authors**

Architekt G. W. Reinberg  
S. Grünewald, S. Rottensteiner

**Contact**

Thomas Mach  
[thomas.mach@technikwien.at](mailto:thomas.mach@technikwien.at)



## 1.4 Brochure Enhancement house StValentin

**PROJECT SUMMARY**  
Renovation of a single-family house built in 1982 with vertical enhancement for a second housing unit and an annex for a staircase.

**SPECIAL FEATURES**  
- components of a Passive House in the first floor  
- ventilation system with heat recovery and air heating

**ARCHITECT**  
Atelier für Solararchitektur - JORDAN  
T. Wimmer, MAS

**OWNER**  
Fam. W.  
Private



### Enhancement house in St. Valentin - AT



IEA – SHC Task 37  
Advanced Housing Renovation with Solar & Conservation



#### BACKGROUND

The residential building, a single family bungalow in St. Valentin near Linz, was built in the 1980s with a coke boiler, later on with an oil driven floor heating system, a central supply of hot water by electricity and a typical building envelope with a space heating demand of 198 kWh/(m<sup>2</sup>a). The fabric of the building was in a good condition but with very few insulation.

After renovation 2006 with an intensive engagement of the owner, a new storey built with wooden framework walls, almost complies with Passive House standard and the ground floor is up to the mark of low energy requirements. The whole building achieves 30 kWh/(m<sup>2</sup>a) space heating demand.

#### OBJECTIVES OF THE RENOVATION

- doubling of the living space
- reduction of the heating costs to a minimum
- high degree of pre-fabrication
- to meet low energy requirements in the ground floor
- to comply with Passive House standard in the new storey
- renovation with a least distribution of residents
- to construct an economic building

#### SUMMARY OF THE RENOVATION

- insulation of the building envelope: roof (456 mm), façade (300 mm) basement ceiling (120 mm)
- one new window in the ground floor
- windows meeting Passive House standard in the upper floor
- enhancement of the ground floor
- utilization of prefabricated wall units (first floor)
- addition of a staircase
- new sanitary installations
- ventilation system with heat recovery and air/air heat pump in the first floor
- central vacuum cleaner system

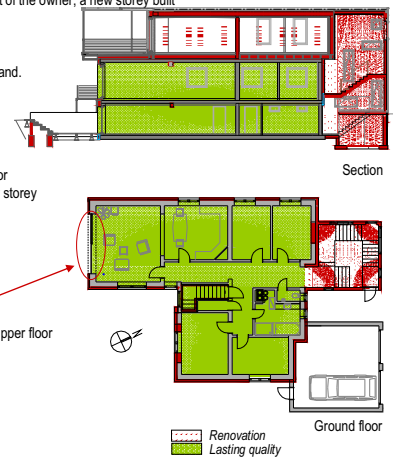

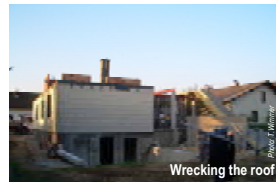

**CONSTRUCTION**

**Roof construction** *U-value: 0.089 W/(m<sup>2</sup>·K)*  
(interior to exterior)

plasterboard	15 mm
roof board	24 mm
OSB airtight	18 mm
cellulose insulation	456 mm
softboard	16 mm
air space	60 mm
boarding	24 mm
roof foil	2 mm
<b>Total</b>	<b>615 mm</b>

**Wall construction** *U-value: 0.109 W/(m<sup>2</sup>·K)*  
(interior to exterior)

plasterboard	15 mm
OSB airtight	11 mm
insulation	100 mm
OSB airtight	18 mm
cellulose insulation	300 mm
softboard	16 mm
air space	50 mm
façade panel	10 mm
<b>Total</b>	<b>520 mm</b>

**Basement ceiling** *U-value: 0.211 W/(m<sup>2</sup>·K)*  
(top down)

floor construction (existing)	121 mm
brick	250 mm
insulation	120 mm
plaster	2 mm
<b>Total</b>	<b>493 mm</b>

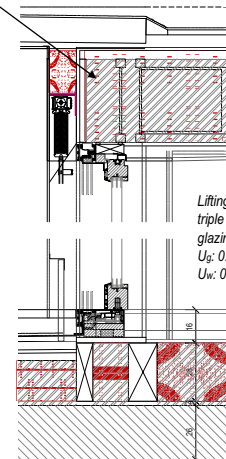

Lifting sliding door:  
triple thermopane  
glazing  
 $U_g: 0.60 \text{ W/(m}^2 \cdot \text{K)}$   
 $U_w: 0.86 \text{ W/(m}^2 \cdot \text{K)}$

Window section



**Summary of U-values W/(m<sup>2</sup>·K)**

	Before	After
Attic floor	0.5	0.09
Walls	0.7	0.11
Basement ceiling	1.0	0.21
Windows	2.8	0.86

**BUILDING SERVICES**

A new centralised ventilation system with heat recovery (efficiency 90%) combined with an air/air heat pump is installed in the first floor. The preheating of the cold air is realized with a earth to air heat exchanger. The existing floor heating and the floor heating in the first floor is working with the central oil heating, 22 kW (1998). Aim of the owner is to use the oil heating system infrequently. The domestic hot water is heated by the central oil heating. Reduction of the heating cost of 2/3 is reached even though the usable floor space is doubled from 165 m<sup>2</sup> to 337 m<sup>2</sup>.

**RENEWABLE ENERGY USE**

The residents are planning to create an energy self-sufficient building. The first step will be the change from oil heating to an air/air heat pump, followed by windmills and PV for providing electricity.

**ENERGY PERFORMANCE**

Space + water heating (primary energy)\*  
Before: 317 kWh/(m<sup>2</sup> a)  
After: 66.7 kWh/(m<sup>2</sup> a)  
Reduction: 79% (existing oil heating)

Future reduction: 93% (new pellets heating)

\*according to OIB Richtlinie 6

**INFORMATION SOURCES**

JORDAN (architektur & energie)  
Thomas Wimmer, MAS  
Am Hartfeld 8  
4300 St. Valentin  
www.jordan-solar.at

**Brochure authors**

S. Grünwald, S. Rottensteiner

**Contact**

Thomas Mach  
thomas.mach@tugraz.at



## 1.5 Brochure 5-storey apartment house Linz

**PROJECT SUMMARY**  
Renovation of an apartment building built in 1958 complying with Passive House standard. New façade with 'Gap-Solar Façade' system and closed, glazed balconies.

**SPECIAL FEATURES**  
- Gap-Solar Façade  
- decentral ventilation system with heat recovery and air heating

**ARCHITECT**  
ARCH+MORE ZT GmbH  
Arch. DI Ingrid Domenig-Meisinger

**OWNER**  
GIWOG - Gemeinnützige Industrie-Wohnungsaktiengesellschaft  
Co-operative



### 5-storey apartment house in Linz - Makartstraße - AT



IEA – SHC Task 37  
Advanced Housing Renovation with Solar & Conservation



#### BACKGROUND

The fabric of the building with 50 flats, which is almost five decades old, was in a good condition. The exterior walls, constructed out of poured concrete were not insulated and the space heat demand of the building was 117 kWh/(m<sup>2</sup>a). An insulation was later applied to parts of the cellar ceiling. The energetic improvement of the building equipment, the reduction of thermal bridges and the air-proof envelope were the key aspects of the modernization. After renovation 2006, the apartment building complies with Passive House standards and achieves 11.1 kWh/(m<sup>2</sup>a) space heating demand. The building project was subsidized by the federal state of Upper Austria and by the program 'House of the future' conducted by the Austrian Federal Ministry of Transport, Innovation and Technology (BMVIT)

#### SUMMARY OF THE RENOVATION

- high insulation of the façade, floors, roofs
- triple glazing of windows including an anti-glare shield
- decentral ventilation system with heat recovery and air heating
- highly insulated outside walls by using the "Gap-Solar Façade"
- enlargement of floor space by closing the balconies
- utilization of prefabricated wall units, which have the dimension of a flat width and floor height
- domestic hot water preparation with district heating

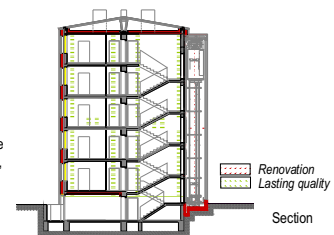

#### OBJECTIVES OF THE RENOVATION

- reduction of the heating costs to a minimum
- optimized ventilation and building services concept
- ecological renovation with renewable resources
- high degree of pre-fabrication
- renovation with a least distribution of residents

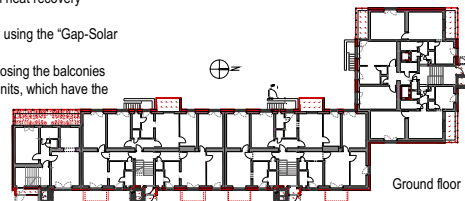





**CONSTRUCTION**

<b>Roof construction</b> (top down)	<i>U-value: 0.094 W/(m² K)</i>
fibre cement tile	
roof structure construction	
rock wool	400 mm
floor screed	30 mm
crushed slag course	100 mm
reinforced concrete	140 mm
plaster	20 mm
Total	690 mm
<b>Wall construction</b> (interior to exterior)	<i>U-value: 0.158 W/(m² K)</i>
plaster	20 mm
slag concrete	300 mm
insulation	60 mm
OSB airtight	16 mm
mineral wool	130 mm
MDF	4 mm
solar comb	50 mm
air gap (slightly ventilated)	31 mm
ESG float glass panel	6 mm
Total	617 mm
<b>Basement ceiling</b> (top down)	<i>U-value: 0.206 W/(m² K)</i>
existing floor	100 mm
reinforced concrete	150 mm
porous concrete	50 mm
rock wool	100 mm
Total	400 mm

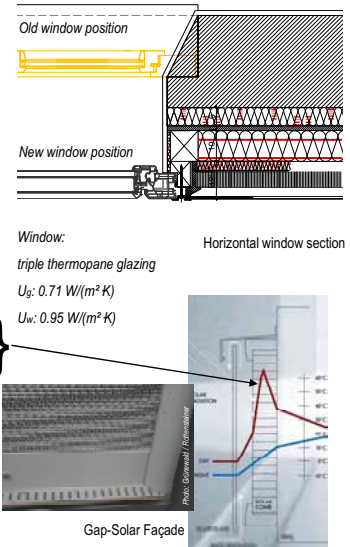

**BUILDING SERVICES**

The building will meet the requirements of a Passive House by means of prefabricated ventilated Gap-Solar Façade, reinforced insulation of top floor and cellar ceiling, enlargement of existing balconies including parapet insulation, glazing with Passive House windows including integrated sun protection.

A decentral controlled room ventilation with heat recovery (efficiency 70%), air heating and single room ventilators is installed. The existing space heating system is in a good condition. Therefore this system is used, additionally to the room ventilation system, though with lower flow temperature and new room thermostats.

Domestic hot water is prepared with district heating instead of decentral gas heating.

The expected energy savings of about 327.000 kWh/a are decreasing carbon dioxide emissions from about 132.000 kg/year to 29.000 kg/year.

Before modernization: heating costs for a flat of 59 m²: € 40.80 /month – after modernization: € 4.73 /month.

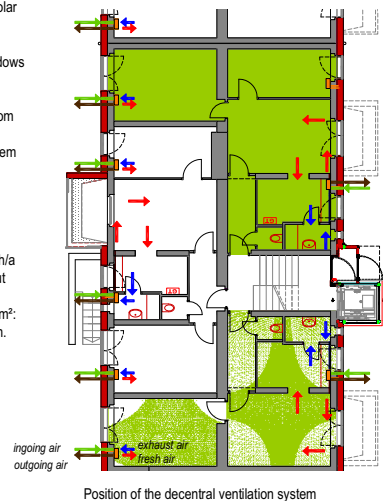



**Summary of U-values W/(m<sup>2</sup>·K)**

	Before	After
Attic floor	0.9	0.09
Walls	1.3	0.16 <sup>1)</sup>
Basement ceiling	0.5	0.21
Windows	ca. 2.8	0.95

<sup>1)</sup> Dynamic U-value with solar input (Gap-Solar Façade)

**RENEWABLE ENERGY USE**

The Gap-Solar Façade system consists of a special cellulose comb, arranged behind a façade of glass panels. The solar radiation enters the solar comb and warms it up. A warm zone is created on the outside wall, which reduces the thermal losses. The solar honey-comb acts as a solar absorber. The efficiency of the gap-solar façade depends on the quantum of sunlight and on the orientation. On the south facing façade nearly no thermal losses are possible, with average dynamic U-values of about 0.08 W/m<sup>2</sup>·K during the heating season.

**ENERGY PERFORMANCE**

Space + water heating (primary energy) \*  
 Before: 120 kWh/(m<sup>2</sup>a)  
 After: 23.0 kWh/(m<sup>2</sup>a)  
 Reduction: 81 %

\* according to OIB Richtlinie 6

**INFORMATION SOURCES**

[Passiv House renovation, Makartstrasse, Linz, report of energy end environment research 21/2007, bmvit, building of tomorrow](#)

Ingrid Domenig-Meisinger  
 domenig@arch-more.com

**Brochure authors**

I. Domenig-Meisinger  
 S. Grünewald, S. Rottensteiner

**Contact**

Thomas Mach  
 thomas.mach@tugraz.at





## 1.6 Brochure Singlefamily house Pettenbach

### Single - family house in Pettenbach - AT

#### PROJECT SUMMARY

Renovation of a summer residence, built in 1962 with a vertical enhancement and new façade elements. Reduction of primary energy demand: 98%. Complies with Passive House standard.

#### SPECIAL FEATURES

- central ventilation system with heat recovery and air heating
- vacuum insulation
- photovoltaic panels

#### PLANNER

Lang Consulting  
Ing. G. Lang, M. Lang

#### OWNER

Fam. S.  
Private



IEA – SHC Task 37  
Advanced Housing Renovation with Solar & Conservation



Before



After



#### BACKGROUND

The fabric of the summer residence, built in 1962, was in a poor condition. The exterior walls, constructed out of wood chip concrete, had no insulation, with the original windows still in place. In 1980 a small expansion with an underneath basement was made. The space heating and the domestic hot water preparation was provided by a central gas heating and the building had a space heating demand of 367 kWh/(m<sup>2</sup>a). After the renovation 2005 to a single family house for a young family, the building complies to Passive House standard and achieves 12 kWh/(m<sup>2</sup>a) space heating demand. The building project was subsidized by the program 'House of the future' conducted by the Austrian Federal Ministry of Transport, Innovation and Technology (BMVIT).

#### OBJECTIVES OF THE RENOVATION

- reduction of the heating costs to a minimum
- optimized ventilation and building services concept
- ecological renovation with renewable resources
- high degree of pre-fabrication
- to meet the Passive House standard

#### SUMMARY OF THE RENOVATION

- insulation of the building envelope: roof (355 mm), façade (440 mm) basement ceiling (440 mm)
- vacuum floor insulation (20 mm)
- prefabricated hook-in timber wall
- windows meeting Passive House standard
- enhancement of the ground floor
- photovoltaic panels
- central ventilation system with heat recovery and air heating

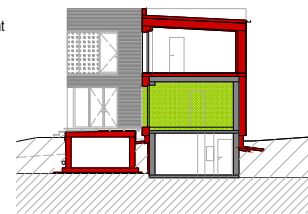

Section

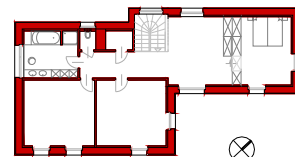

Second floor

Renovation  
Lasting quality

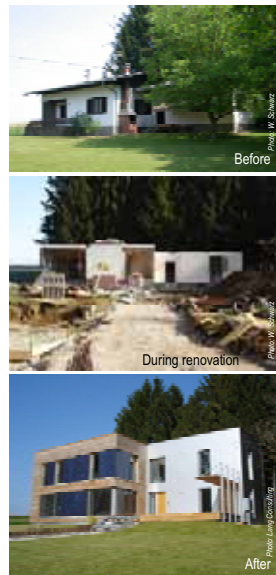

The renovation should be adapted to the lasting quality as much as possible and depending on the new room functions, only the most essential demolition works were done.

The roof and some of the partitions were demolished.

To achieve a modern living it was necessary to transform (change) the mainly small rooms (room structure) by consolidating rooms in the ground floor. As a result, a generous living-dining-room with an open kitchen was created.

Before the renovation, most of the rooms were very dark because of the small windows. Due to the high thermal quality of the new windows, ceiling-high glazings with an high incidence of daylight were possible.

Opening the south facing corner created an extension and integrated the terrace and the garden into the living area. The main body of the building consists of two shifted cubes.



**HOOK-IN TIMBER WALL CONSTRUCTION**

The encasement of the ground floor is the basis of the innovative rehabilitation concept. Adapted to the existing building, the suspension points were set and measured, and the hook-in parts were preinstalled on the wall elements as provided for by the 3D-CAD planning.

The elements including the façade and the windows without any further attachment were installed smoothly on the spot during the first day. This is how the timber construction can make full use of its benefits even in the rehabilitation of old buildings. The insulation material used was cellulose, which levels out the irregularities of the existing building, leaving no joints at all.

**VACUUM INSULATION**

As for the floor, the high insulation standard could be reached by using vacuum insulation although the floor height was limited.





**CONSTRUCTION**

**Roof construction** *U-value: 0.094 W/(m²·K)*

(interior to exterior)	
plasterboard	13 mm
mineral wool insulation	40 mm
OSB airtight	16 mm
cellulose insulation	440 mm
softboard	15 mm
roof covering with air space	80 mm
<b>Total</b>	<b>604 mm</b>

**Wall construction** *U-value: 0.112 W/(m²·K)*

(interior to exterior)	
lime plaster	15 mm
wood chip concrete	250 mm
lime plaster	25 mm
cellulose insulation	355 mm
softboard	16 mm
air space	45 mm
wood boards	30 mm
<b>Total</b>	<b>736 mm</b>

**Basement ceiling** *U-value: 0.132 W/(m²·K)*

(top down)	
parquet	16 mm
floor screed	50 mm
extrude polystyrene	80 mm
vacuum insulation	20 mm
reinforced concrete floor	300 mm
extrude polystyrene	50 mm
<b>Total</b>	<b>516 mm</b>

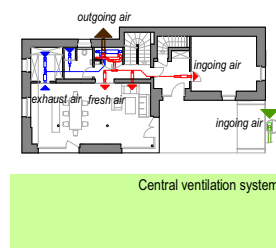
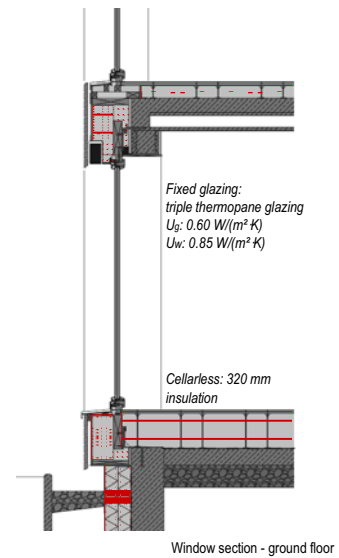

**Summary of U-values W/(m²·K)**

	Before	After
Attic floor	1.2	0.09
Walls	1.0	0.11
Basement ceiling	0.5	0.13
Windows	ca. 2.6	0.85

**BUILDING SERVICES**

The building meets the requirements of a Passive House through an added insulation of top floor and cellar ceiling, prefabricated highly insulated hook-in timber walls, reduction of thermal bridges, triple glazed windows and an airtight envelope.

A new compact central ventilation system, with heat recovery (efficiency 86%) combined with an air/air heat pump is installed. The preheating of the cold air is realized with an earth to air heat exchanger. The system using a highly efficient compact unit ensures permanent supply of fresh air throughout the building and covers the required residual heating and hot water demand. The remaining heating energy demand is covered by electricity with low temperature heating panels.

The expected energy savings of about 56.000 kWh/a are decreasing carbon dioxide emissions from about 14.000 kg/year to 1.200 kg/year.

**RENEWABLE ENERGY USE**

The 2.4 kWp photovoltaic panels integrated into the façade achieve an annual rate of 60% of the auxiliary heat demand operated by electricity.

**ENERGY PERFORMANCE**

Space + water heating (primary energy)\*

Before: 548 kWh/(m²a)

After: 13.4 kWh/(m²a)

Reduction: 98 %

\*according to OIB Richtlinie 6

**INFORMATION SOURCES**

[The very first reconstruction in Austria of a one-unit house to passive house standard \(Model project in Pottenbach/Upper Austria\), report of energy end environment research 38/200/, bmvit building of tomorrow](#)

Family S.

**Brochure authors**

S. Grünewald, S.Rottensteiner

**Contact**

Thomas Mach  
thomas.mach@tugraz.at



## 1.7 Brochure Historic building Irdning

**PROJECT SUMMARY**  
Renovation of a historic building in Irdning built in 1567, with four flats and two shops. Complies with low energy requirement.

**SPECIAL FEATURES**  
- Central ventilation system with heat recovery  
- activation of the thermal mass  
- 8 m<sup>2</sup> solar panels for domestic hot water preparation

**ARCHITECT**  
Hegedys & Ull, Gebäude und Naturraum Projektierung GMBH

**OWNER**  
Fam. H.  
Private



### Historic building in Irdning - AT



IEA – SHC Task 37  
Advanced Housing Renovation with Solar & Conservation



#### BACKGROUND

The fabric of the two-storey 16th century building was in a very poor condition. The massive exterior walls were not insulated, moist, with the original windows still in place. The space heating was supplied by a central oil heating. The domestic hot water was prepared by electricity and the space heating demand of the building was 199 kWh/(m<sup>2</sup>a).

After a highly ecological renovation 2006 and an intensive engagement of the owner, the building achieves 38 kWh/(m<sup>2</sup>a) space heating demand. The building was renovated without any subsidies.

#### OBJECTIVES OF THE RENOVATION

- reduction of the heating costs to a minimum
- highly ecological renovation with renewable resources
- optimized building performance
- to meet low energy requirements
- conservation of the outward appearance of the building

#### SUMMARY OF THE RENOVATION

- high insulation on the exterior of the façade, roof and basement
- renovation of the old windows, doors restored
- closing of the court
- construction of four flats
- preservation of stucco ornamentation on ceiling and walls
- central ventilation system with heat recovery
- solar panels for domestic hot water preparation
- district heating with biomass
- activation of the thermal mass
- new electrical and sanitary installations

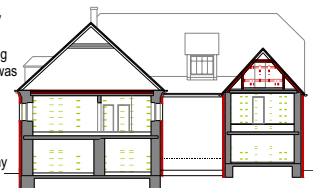

Section

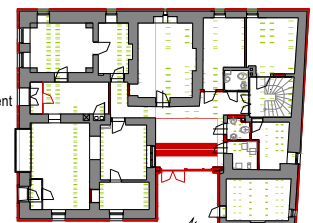

Ground floor

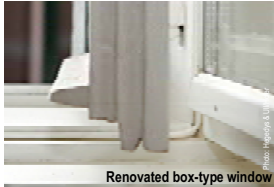

Renovated box-type window

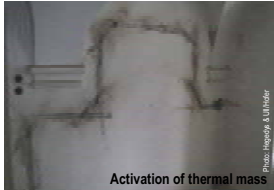

Activation of thermal mass



**CONSTRUCTION**

**Roof construction** *U-value: 0.178 W/(m<sup>2</sup> K)*  
(interior to exterior)

plasterboard	15 mm
boarding	24 mm
cellulose insulation	220 mm
boarding	24 mm
air space	
lathing	40 mm
<b>roof covering</b>	
<b>Total</b>	<b>323 mm</b>

**Wall construction** *U-value: 0.245 W/(m<sup>2</sup> K)*  
(interior to exterior)

lime plaster	15 mm
solid brick	500 mm
mineral wool insulation	140 mm
lime plaster	20 mm
<b>Total</b>	<b>675 mm</b>

**Basement ceiling** *U-value: 0.285 W/(m<sup>2</sup> K)*  
(top down)

slab	15 mm
floor screed	60 mm
cork insulation	130 mm
reinforced concrete floor	100 mm
crushed brick	150 mm
<b>Total</b>	<b>455 mm</b>

**Box-type window interior casement**  
*U-value: 1.60 W/(m<sup>2</sup> K)*



Mildew in the ground floor



Removing the existing floor





Central ventilation system



District heating system and hot water storage

**BUILDING SERVICES**

A new central ventilation system with heat recovery (efficiency > 95%), a biomass driven fan-coil, is installed. The preheating of the cold air is realized with a ground-air heat exchanger. The space heating is provided by a biomass driven district heating by activating the thermal mass from the building and some radiators are installed. Domestic hot water is heated by solar panels and the remaining heat demand is covered by the central district heating, instead of a central electric boiler.



Solar panels on the roof

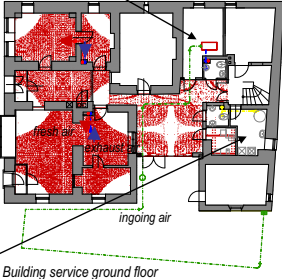

Building service ground floor

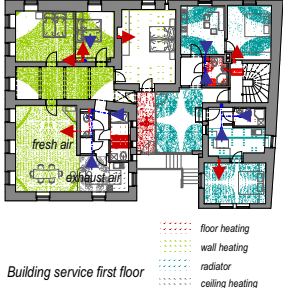

Building service first floor

- floor heating
- wall heating
- radiator
- ceiling heating

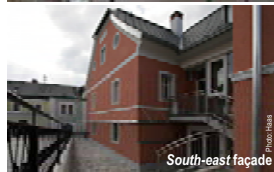

**Summary of U-values  $W/(m^2 \cdot K)$**

	Before	After
Attic floor	0.7	0.18
Walls	0.9	0.25
Basement ceiling	2.0	0.29
Windows	ca. 2.7	1.35

**RENEWABLE ENERGY USE**

8 m<sup>2</sup> solar panels for domestic hot water preparation are installed on the southeast-oriented roof. High usage of ecological material.



**ENERGY PERFORMANCE**

Space + water heating (primary energy)\*  
 Before: 322 kWh/(m<sup>2</sup>a)  
 After: 15.9 kWh/(m<sup>2</sup>a)  
 Reduction: 95 %

\* according to OIB Richtlinie 6

**INFORMATION SOURCES**

Hegedys & Ull  
 Gebäude und Naturraum Projektierung GMBH  
 Mitterlaßnitzberg 31  
 8302 Nestelbach bei Graz  
 www.hegedys-ull.at

**Brochure authors**  
 S.Grünwald, S.Rottensteiner

**Contact**  
 Thomas Mach  
 thomas.mach@tugraz.at





## 1.8 Brochure Single-family house St.Martin

**PROJECT SUMMARY**  
Renovation of a single-family house built in 1973 with vertical enhancement for a second housing unit, an annex for a staircase and a living room. Complies with low energy requirements.

**SPECIAL FEATURES**  
- central ventilation system with heat recovery  
- geothermal heat pump

**ARCHITECT**  
Grundstein Architektur  
Architektin Dipl. Ing. I. Prieler

**OWNER**  
Fam. S. & Fam. H.  
Private



### House in St. Martin - AT



IEA – SHC Task 37  
Advanced Housing Renovation with Solar & Conservation

**Before**



**After**



#### BACKGROUND

The single family house in St. Martin am Tennengebirge was built in 1973 with a central oil heating, a central preparation for domestic hot water by electricity and a typical building envelope with a space heating demand of 230 kWh/(m<sup>2</sup>a). After renovation 2007 and an intensive engagement of the owner, the new storey built with wooden framework walls and the renovated two existing storeys complies with low energy requirements. The building achieves 17 kWh/(m<sup>2</sup>a) space heating demand.

#### OBJECTIVES OF THE RENOVATION

- enlargement of the living space
- reduction of the heating costs to a minimum
- to meet low energy requirements
- to construct an economic building
- renovation with least annoyance of residents

#### SUMMARY OF THE RENOVATION

- insulation of the building envelope: roof (280 mm), façade (240 mm) basement ceiling (160 mm)
- Triple glazed windows in the new storey
- enhancement of the first floor
- utilization of prefabricated wall units (second floor)
- new staircase
- enlargement of the kitchen
- new sanitary installations
- mechanical ventilation with heat recovery and air heating
- geothermal heat pump

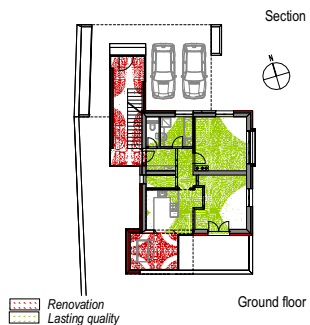
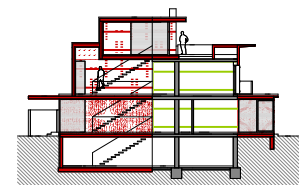

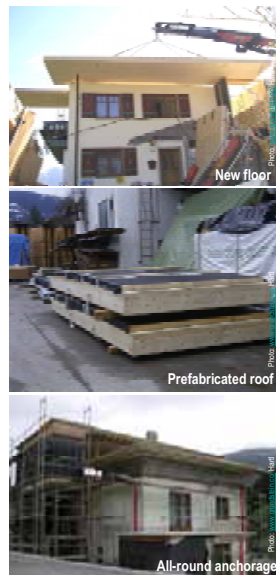

**CONSTRUCTION**

**Roof construction** *U-value: 0.088 W/(m<sup>2</sup>·K)*  
(interior to exterior)

softboard	40 mm
OSB airtight	15 mm
mineral wool insulation	280 mm
roof battening	23 mm
mineral wool insulation	160 mm
roof battening	23 mm
roof foil	1 mm
Total	542 mm

**Wall construction** *U-value: 0.127 W/(m<sup>2</sup>·K)*  
(interior to exterior)

boarding	20 mm
air space	25 mm
softboard	40 mm
OSB airtight	15 mm
mineral wool insulation	240 mm
softboard	40 mm
air space	25 mm
boarding	20 mm
Total	425 mm

**Basement Ceiling** *U-value: 0.197 W/(m<sup>2</sup>·K)*  
(top down)

floor construction (existing)	121 mm
concrete floor (existing)	160 mm
expanded polystyrene EPS	160 mm
plaster	15 mm
Total	456 mm

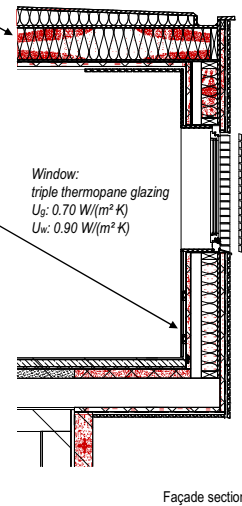

**Summary of U-values W/(m<sup>2</sup>·K)**

	Before	After
Attic floor	1.2	0.09
Walls	1.3	0.13
Basement ceiling	0.9	0.20
Windows	ca. 2.5	0.90

**BUILDING SERVICES**

The space heating system is operating with a geothermal heat pump. In the new storey a floor heating is installed and in the renovated storeys the existing radiators are used. A new central ventilation system with heat recovery (efficiency 90%) and air heating is installed in the whole building. The preheating of the cold air is realized with an earth to air heat exchanger. Domestic hot water is heated by the geothermal heat pump with an antibacterial preparation.

**RENEWABLE ENERGY USE**

Opportunity for a future use of Photovoltaics.

**ENERGY PERFORMANCE**

Space + water heating (primary energy)\*  
Before: 459 kWh/(m<sup>2</sup>a)  
After: 11.7 kWh/(m<sup>2</sup>a)  
Reduction: 97 %

\* according to OIB Richtlinie 6

**INFORMATION SOURCES**

Grundstein Architektur  
Grundsteingasse 14/19  
A-1160 Wien  
www.grundstein.cc

**Brochure authors**

S. Grünewald, S. Rottensteiner

**Contact**

Thomas Mach  
thomas.mach@tugraz.at





## 1.9 Brochure Single-family house Kufstein

**PROJECT SUMMARY**  
Renovation of a detached house built in 1981 with a new façade and an enlargement of the living space. Complies with low energy requirements.

**SPECIAL FEATURES**  
- 16 m<sup>2</sup> solar panels for domestic hot water preparation  
- extension of a transparent building unit

**ARCHITECT**  
R. Pfurtscheller

**OWNER**  
Fam. K.  
Private



### Single-family house in Kufstein - AT



IEA – SHC Task 37  
Advanced Housing Renovation with Solar & Conservation

**Before**

Photo: K. Schöffner

**After**

Photo: K. Schöffner

#### BACKGROUND

The single family house in Kufstein was built in 1981 with a later installed central oil heating, a central preparation for domestic hot water by the oil heating and a typical building envelope with a space heating demand of 92 kWh/(m<sup>2</sup>a). After renovation a new energy optimized modern shell is detached on the building and complies to low energy requirements. The building achieves 46 kWh/(m<sup>2</sup>a) space heating demand.

#### OBJECTIVES OF THE RENOVATION

- enlargement of the living space
- reduction of the heating costs
- transformation of the architecture
- larger windows for a higher comfort

#### SUMMARY OF THE RENOVATION

- high insulation of the building envelope
- triple thermopane glazed windows
- enlargement of the living space
- energy optimized modern shell
- reduction of the thermal bridges
- new sanitary installations
- new kitchen layout
- more and larger windows
- solar panels for domestic hot water preparation

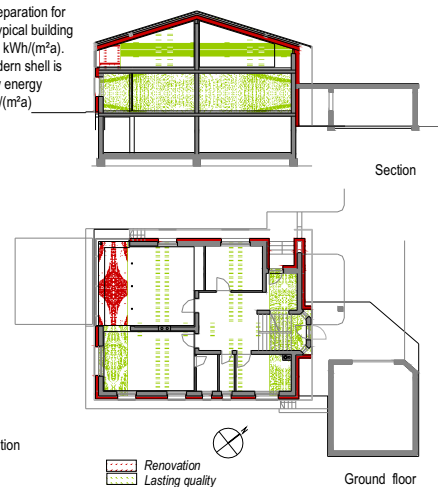

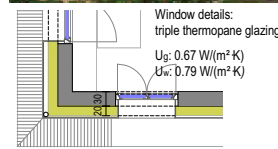

**CONSTRUCTION**

**Roof construction**  $U\text{-value: } 0.115 \text{ W/(m}^2 \text{ K)}$   
(interior to exterior)

plywood	20 mm
rock wool insulation (existing)	250 mm
rock wool insulation	120 mm
air space	40 mm
lathing	35 mm
roof brick	
<b>Total</b>	<b>465 mm</b>

**Wall construction**  $U\text{-value: } 0.133 \text{ W/(m}^2 \text{ K)}$   
(interior to exterior)

plywood	20 mm
plaster interior	10 mm
brick	300 mm
plaster	20 mm
rock wool insulation	200 mm
plywood (black painted)	20 mm
air space	
lathing	
<b>Total</b>	<b>570 mm</b>

**Ceiling**  $U\text{-value: } 0.762 \text{ W/(m}^2 \text{ K)}$   
(top down)

floor construction (existing)	131 mm
concrete floor (existing)	160 mm
<b>Total</b>	<b>291 mm</b>

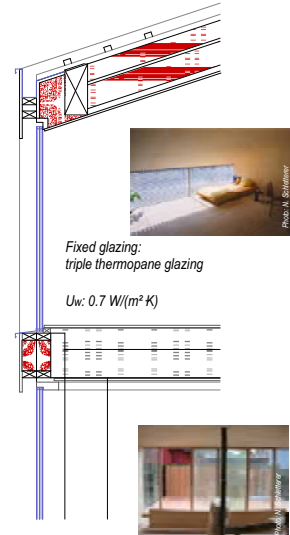

Window section

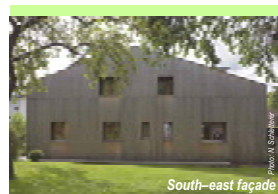

**Summary of U-values W/(m² K)**

	Before	After
Attic floor	ca. 0.2	0.12
Walls	ca. 0.3	0.13
Basement ceiling	ca. 0.8	0.8
Windows	ca. 2.5	0.79

**BUILDING SERVICES**

The building meets the requirements of a low energy standard through a high insulation of the roof and the walls, reduction of thermal bridges and windows with triple thermo pane glazing. The demand of heating energy is covered by the central oil heating and domestic hot water is heated by solar collectors. The remaining hot water energy demand is covered by the central oil heating.

**RENEWABLE ENERGY USE**

10 m² solar panels for domestic hot water preparation. The owners are planning to further improve the energy efficiency of the building. The next step will be the replacement of the oil heating boiler by a pellet stove.

**ENERGY PERFORMANCE**

Space + water heating (primary energy)\*  
Before: 176 kWh/(m² a)  
After: 124.9 kWh/(m² a)  
Reduction: 29% (existing oil heating)

Future reduction 93% (new pellets heating)

\*according to OIB Richtlinie 6

**INFORMATION SOURCES**

Madritsch & Pfurtscheller  
Erzherzog Eugen Str. 41  
A-6020 Innsbruck  
www.madritschpfurtscheller.at

**Brochure authors**

S. Grünwald, S. Rottensteiner

**Contact**

Thomas Mach  
thomas.mach@tugraz.at



## 1.10 Brochure Attic conversion Innsbruck

**PROJECT SUMMARY**  
Renovation of an attic conversion of a historic building in Innsbruck built in 1882 with two new levels in two connected wooden boxes. Complies with low energy requirements.

**SPECIAL FEATURES**  
- 15 m<sup>2</sup> solar panels for DHW preparation  
- laminated wooden roof construction  
- connected wooden boxes

**ARCHITECT**  
Dipl Ing D. Fügenschuh

**OWNER**  
Dr. H.  
Private

### Attic conversion in Innsbruck - AT



IEA – SHC Task 37  
Advanced Housing Renovation with Solar & Conservation



#### BACKGROUND

The massive exterior walls of this five storey 19th century building were not insulated, the original windows are still in place. The attic floor was not used and the roof structure was in a poor condition. The apartment on the top achieved 193 kWh/(m<sup>2</sup>a).

After the renovation 2007 the attic conversion offers high comfort with a three level open room and new included levels. The conversion complies with low energy requirements and achieves 55 kWh/(m<sup>2</sup>a) space heating demand.

#### OBJECTIVES OF THE RENOVATION

- reduction of the heating costs
- ecological renovation with renewable resources
- extremely high quality of building and construction
- dimensions of the interior design

#### SUMMARY OF THE RENOVATION

- high insulation of façade, floors, roofs
- replacement of old windows
- two connected wooden boxes for new living space
- central gas unit
- solar panels for preparation of domestic hot water

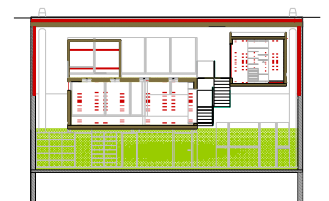

Attic section

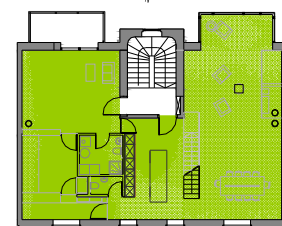

Renovation  
Lasting quality

First attic floor

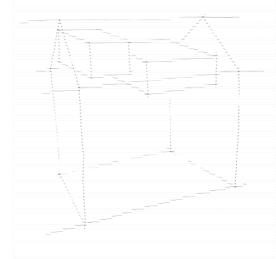
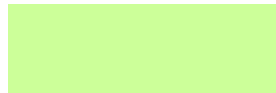

Wood-box system

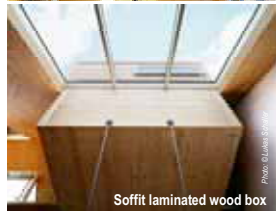
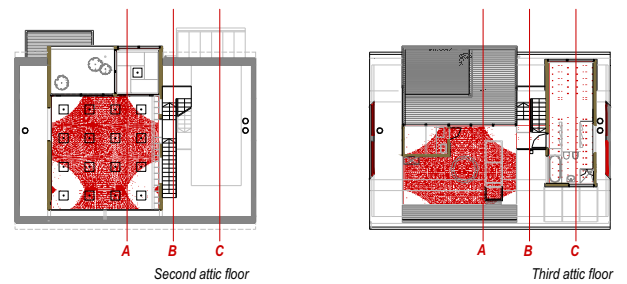
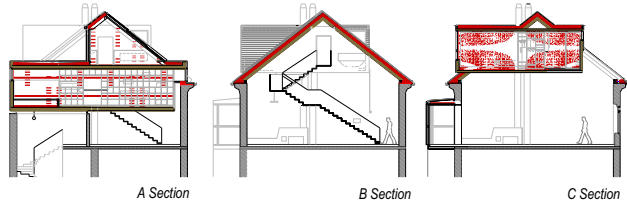
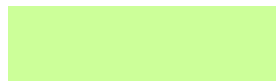

**CONSTRUCTION**

**Roof construction**  $U$ -value: 0.184 W/(m<sup>2</sup> K)  
(interior to exterior)

laminated wood	218 mm
wood-fibre insulation	140 mm
air space	
green roof, solar panels, copper	
<b>Total</b>	<b>358 mm</b>

**Wall construction**  $U$ -value: 0.285 W/(m<sup>2</sup> K)  
(interior to exterior)

laminated wood	150 mm
wood-fibre insulation	80 mm
air space	30 mm
boaring	20 mm
<b>Total</b>	<b>280 mm</b>

**Separating ceiling**  $U$ -value: 0.864 W/(m<sup>2</sup> K)  
(top down)

floor screed	70 mm
impact sound insulation	30 mm
filling	50 mm
concrete floor (existing)	200 mm
<b>Total</b>	<b>350 mm</b>

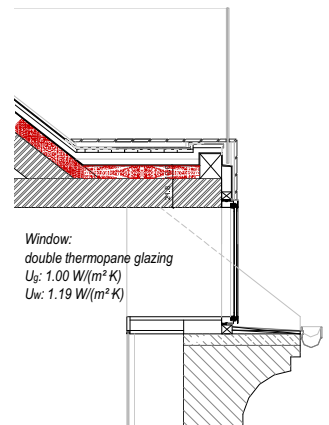

Window section



Photo: Grünwald, Rottensteiner



Photo: Grünwald, Rottensteiner



Photo: Grünwald, Rottensteiner

**Summary of U-values  $W/(m^2 \cdot K)$**

	Before	After
Attic floor	0.8	0.18
Walls	1.1	0.29
Seperating ceiling	0.9	0.86
Windows	ca. 2.7	1.19

**BUILDING SERVICES**

The new floor and wall heating systems are operated with a new central gas heating (10 kW). Domestic hot water is heated by solar panels the remaining demand is covered by the central gas heating.

**RENEWABLE ENERGY USE**

15 m<sup>2</sup> solar panels on the southeast-oriented roof achieve an annual solar fraction of 85% for domestic hot water preparation.

**ENERGY PERFORMANCE**

Space + water heating (primary energy)\*  
 Before: 468 kWh/(m<sup>2</sup>a)  
 After: 124.2 kWh/(m<sup>2</sup>a)  
 Reduction: 74 %

\* according to OIB Richtlinie 6

**INFORMATION SOURCES**

Architekt Daniel Fügenschuh  
 Sonnenstraße 7  
 A-6020 Innsbruck  
 www.fuegenschuh.at

**Brochure authors**

S. Grünwald, S. Rottensteiner

**Contact**

Thomas Mach  
 thomas.mach@tugraz.at



## 1.11 Brochure Old peoples home Landeck

**PROJECT SUMMARY**  
 After renovating the old people's home built in 1976, the residential complex offers a much higher comfort for the old people. The terraces were integrated in the building envelope and barriers were removed to make the building accessible for handicapped people. The building complies with low energy requirements.

**SPECIAL FEATURES**  
 - prefabricated modules  
 - accessible for handicapped people

**ARCHITECT**  
 Gharakhanzadeh & Sandbichler architekten zt gmbh

**OWNER**  
 Township Landeck  
 Public



### Old people's home in Landeck - AT



IEA – SHC Task 37  
 Advanced Housing Renovation with Solar & Conservation

**Before**

**After**

#### BACKGROUND

The terrace structure built in 1976 had become uneconomical due to sub-standard building and so a three stage renovation was planned and realized. In 1999 the east front was renovated and the existing heating system was replaced by a modern central oil heating. Furthermore the windows were substituted to achieve better thermal comfort. These improvements resulted in a space heating demand of 59 kWh/(m<sup>2</sup>a).

After the second phase of renovation in 2004 which consisted of a remodelling of the building with 89 rooms instead of 109 (79 rooms for residents, 10 for employees), the energy standard of the building complies with low energy requirements and achieves 38 kWh/(m<sup>2</sup>a) space heating demand.

The building activity was subsidized by the federal state of Tyrol.

#### OBJECTIVES OF THE RENOVATION

- reduction of the operating and maintenance costs
- ecological renovation with renewable resources
- to comply with low energy requirements
- renovation with least annoyance of residents
- high use of pre-fabrication modules
- renovation in stages

#### SUMMARY OF THE RENOVATION

- high insulation of the west, north and south façade, floors, roofs
- new windows on the west façade
- enlargement of floor space by closing the terraces
- reduction of thermal bridges
- utilization of prefabricated modules, which have the dimension of a room width and height
- additional conservatory

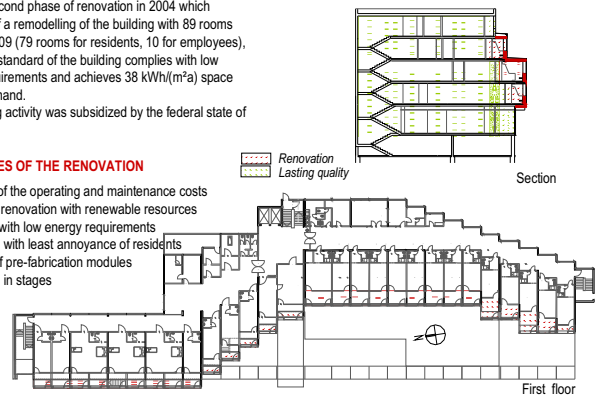



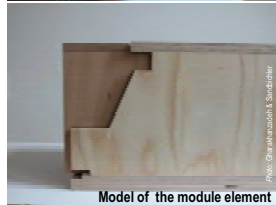

**CONSTRUCTION**

**Roof construction** *U-value: 0.124 W/(m²·K)*

plaster (existing)	15 mm
reinforced concrete (existing)	230 mm
cellulose insulation	300 mm
wood boarding	24 mm
air space	20 mm
gravel, sealing layer	80 mm
Total	669 mm

**Wall construction** *U-value: 0.193 W/(m²·K)*

wood board	18 mm
lathing	70 mm
OSB airtight	25 mm
wood-fibre insulation	230 mm
hard board	15 mm
pre-oxidised copper sheet on corrugated aluminium and air space	56 mm
Total	414 mm

**Basement ceiling** *U-value: 0.146 W/(m²·K)*

floor construction (existing)	120 mm
reinforced concrete ceiling (existing)	180 mm
mineral wool insulation	180 mm
Total	480 mm

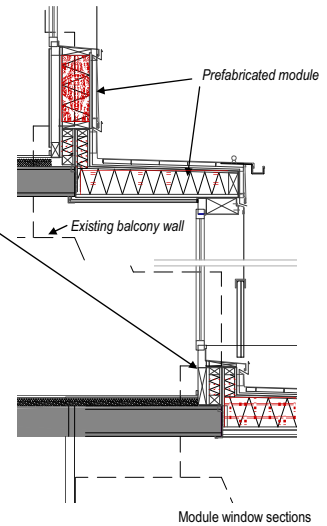

**Summary of U-values W/(m²·K)**

	Before	After
Attic floor	0.1	0.12
Walls	1.3	0.19
Basement ceiling	0.5	0.15
Windows	ca. 2.6	1.20

**BUILDING SERVICES**

Space heating and domestic hot water preparation are provided by the central oil heating, installed in 1999. New heaters are installed. The wood construction's high standard of thermal insulation, teams up with extensive frameless glazing in the West and results in optimal passive solar gains: in conjunction with the existing concrete's thermal mass - it was possible to reduce the annual space heating demand of 65%.

**RENEWABLE ENERGY USE**

A domestic hot water preparation with solar panels and a heating system with renewable energy are planned for the third stage of renovation.

**ENERGY PERFORMANCE**

Space + water heating (primary energy)\*  
 Before: 123 kWh/(m² a)  
 After: 92.9 kWh/(m² a)  
 Reduction: 25% (existing oil heating)

Future reduction: 89% (new pellets heating)

\*according to OIB Richtlinie 6

**INFORMATION SOURCES**

Revitalising with S.A.M. - Synergy Activation Modules, [bmvit](http://bmvit.com) building of tomorrow

Gharakhanzadeh Sandbichler Architekten  
 Westbahnstrasse 26/4  
 A-1070 Wien  
[www.gs-arch.at](http://www.gs-arch.at)

**Brochure authors**

S. Grünwald, S. Rottensteiner

**Contact**

Thomas Mach

[thomas.mach@gs-arch.at](mailto:thomas.mach@gs-arch.at)



## 1.12 Brochure Apartmentbuildings Dornbirn

**PROJECT SUMMARY**  
Renovation of five apartment buildings built in 1980. Reduction of primary energy demand: 59%. Complies with Passive House standard.

**SPECIAL FEATURES**  
- central ventilation system with heat recovery  
- 5x30 m<sup>2</sup> solar panels for DHW preparation and space heating

**ARCHITECT**  
Dipl. Ing. Helmut Kuess

**OWNER**  
VOGEWOSJ Siedlungsgesellschaft  
Co-operative



### Apartmentbuildings Dornbirn - AT



IEA – SHC Task 37  
Advanced Housing Renovation with Solar & Conservation



#### BACKGROUND

The five, three- and four- storey apartment buildings in Fussenuau in Vorarlberg, were constructed in 1980. The exterior walls, made out of brick, were poorly insulated, with the original windows still in place. The space heating was supplied by a gas heating. During the renovation of the 54 apartments only products were used which are suitable for Passive House standard. The reduction of the thermal bridges, the high insulation and the energetic improvement of the building service are responsible for the reduction of the space heating demand from 80 kWh/(m<sup>2</sup>a) to 16 kWh/(m<sup>2</sup>a). The renovation was finished in May 2008. The building project is subsidized by the federal state of Vorarlberg.

#### OBJECTIVES OF THE RENOVATION

- reduction of heating costs to a minimum
- optimized ventilation and building services concept
- renovation with least annoyance of residents
- ecological renovation with mainly renewable building products
- to meet Passive House standard

#### SUMMARY OF THE RENOVATION

- insulation of the building envelope: roof (330 mm), façade (250 mm), basement ceiling (140mm)
- windows meeting Passive House standard (triple glazed windows; Uw-value: 0.8 W/m<sup>2</sup>K)
- glazed balconies
- reduction of thermal bridges
- central ventilation system with heat recovery
- solar panels - solar combisystem
- modernization of the central gas heating

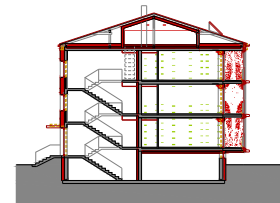

Section



Renovation  
Lasting quality

Ground floor





**CONSTRUCTION**

**Roof construction** *U-value: 0.111 W/(m<sup>2</sup> K)*  
(interior to exterior)

dry screed	20 mm
expanded polystyrene EPS	250 mm
dry screed	20 mm
rock wool	80 mm
reinforced concrete	200 mm
surfacel	5 mm
<b>Total</b>	<b>575 mm</b>

**Wall construction** *U-value: 0.109 W/(m<sup>2</sup> K)*  
(interior to exterior)

plaster	10 mm
brick	90 mm
polyurethane rigid foam sheet	30 mm
high temperature insulating brick	90 mm
plaster	10 mm
expanded polystyrene EPS	250 mm
plaster	5 mm
<b>Total</b>	<b>485 mm</b>

**Ceiling** *U-value: 0.190 W/(m<sup>2</sup> K)*  
(top down)

floor construction (existing)	100 mm
reinforced concrete (existing)	200 mm
expanded polystyrene EPS	140 mm
plaster	5 mm
<b>Total</b>	<b>445 mm</b>

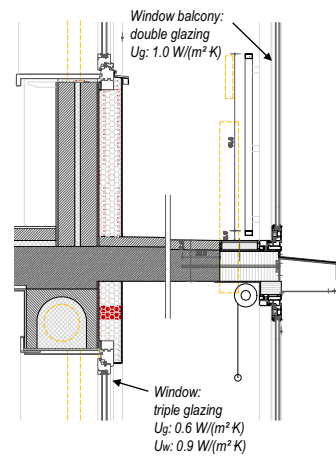

Window and terrace section



**BUILDING SERVICES**

Space heating and domestic hot water is covered by a central gas heating and solar panels. The efficiency factor of the solar heating system is about 60% for domestic hot water and about 17% for the space heating. The heat distribution of the heating is realized within the existing distribution piping.

A new central ventilation system with heat recovery (efficiency > 85 %) is installed in the attic floor of each building.

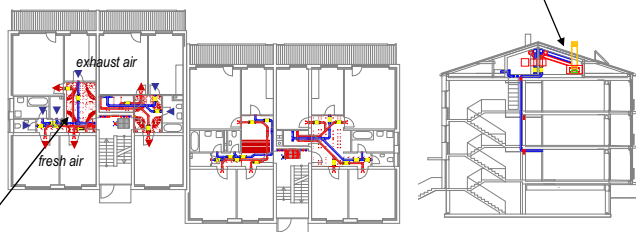



Photo: Architektur Kuess



Photo: Architektur Kuess



Photo: Architektur Kuess

**Summary of U-values W/(m<sup>2</sup>·K)**

	Before	After
Attic floor	0.4	0.11
Walls	0.3	0.11
Basement ceiling	0.8	0.19
Windows	ca. 2.8	0.90

**RENEWABLE ENERGY USE**

The 150 m<sup>2</sup> solar panels on the south-facing roof will achieve an annual solar fraction of 60% for domestic hot water preparation and 17% for space heating.



**ENERGY PERFORMANCE**

Space + water heating (primary energy)\*  
 Before: 146 kWh/(m<sup>2</sup>a)  
 After: 59.1 kWh/(m<sup>2</sup>a)  
 Reduction: 59 %

\* according to OIB Richtlinie 6

**INFORMATION SOURCES**

Architekt DI Helmut Kuess  
 Ehreguttplatz 8  
 A 6900 Bregenz  
 T +43 5574 42 8 45  
 www.architektur-kuess.at

**Brochure authors**

S. Grünewald, S. Rottensteiner

**Contact**

Thomas Mach  
 thomas.mach@tugraz.at



## Anhang - Beiträge zu Subtask C

zum Bericht

### Die österreichische Beteiligung am IEA SHC TASK 37

#### Advanced Housing Renovation with Solar & Conservation

#### Inhalt

1.1	Partizipation als Erfolgsfaktor .....	2
1.2	Einsatzmöglichkeiten solarthermischer Systeme in Sanierungen .....	8
1.3	Aufgespritzte Innendämmung aus Zellulose ohne Dampfbremse.....	32
1.4	Lüftungsanlagen in Sanierungsvorhaben.....	39

Projekt im Rahmen der österreichischen Beteiligung am  
Energietechnologieprogramm der IEA. Im Auftrag des  
Bundesministeriums für Verkehr Innovation und Technologie.

Zusammenstellung T. Mach (Institut für Wärmetechnik, TU Graz) im August 2010



### 1.1 Partizipation als Erfolgsfaktor

Originaltitel:

**Users participation as success factor for advanced housing renovation**  
examples from the Austrian research programme 'Building of Tomorrow'

Claudia Dankl

For each of these phases, answers to the following questions are required:

- Which topics are appropriate for a participation process?
- Which methods lead to reliable results?
- Which groups of users should be integrated?

Results of the above mentioned research project give reason that for the early project development phases only participation of experienced user groups is appropriate. Approaching the point of realisation of a building, it becomes increasingly reasonable to include all prospective users in the planning process.

More information at

<http://www.hausderzukunft.at/results.html/id.1764>

### 5.2.2 Sanierung PRO!

The goal of the project has been the development of a guideline, which supports builders, planners or consultants to organize and monitor inhabitants' participation in renovation processes of multi-storey buildings.

Renovation processes are always interferences in existing constructional and social structures. Planners and builders who work with these structures have to be aware, that renovation is a dynamic process, which has to be optimized constantly. Participants in the construction process are manifold: builders, planners and process consultants as well as actors of politics and administration.

In an ideal renovation process each group reflects on its concepts at the experiences of past renovation projects, in order to develop a high degree of process consciousness. Professional communication and open information towards inhabitants are therefore essential not only during the refurbishment phase, but during the entire term of lease. Due to the high complexity of renovation measures the project team of 'Sanierung PRO!' developed different communication strategies for the different target groups involved:

#### Target group builders and planners

- Current and open information increases the understanding of inhabitants for the building process as well as inhabitants' identification with the object

Every technology has to be applied by users, thus the technological system becomes a socio-technical system. In low-energy and passive housing – newly built or refurbished – technological knowledge and know-how of users is required increasingly. Inhabitants of low-energy and passive houses have to deal with a lot of technological questions and undergo learning processes. The participation of users in planning and building processes raises the likelihood for appropriate handling of the building and its technical equipment later on.

In successful cases participation can result in users' support for innovative technologies, their adequate understanding of the technical building equipment and of the way how to use it. Thus user participation in refurbishment processes can help to make innovation successful, as the innovation term has to be viewed not only in the context of ecology and economics but also from a social point of view.

In the Austrian research programme 'Building of Tomorrow' the acceptance of technologies by users was an important topic. Three projects dealt with users' participation in sustainable refurbishment processes. The following pages provide an overview and a short summary of some of these research and demonstration projects.

### 5.2.1 Sustainable housing concepts and attitudes of users

The research project 'Experiences and attitudes of users as a basis for the development of sustainable housing concepts with high social acceptance' divides user participation during the building process in four phases:

- 1. Research and development,
- 2. Planning,
- 3. Construction
- 4. Use of the building.

- Current enquiries about the constructional conditions of objects – collected e. g. in sort of a building data base – and data on the inhabitant structure are crucial for developing an optimal renovation strategy
- A renovation strategy and different options for action have to be developed before the start of the inhabitant integration
- The builder decides on the character of the inhabitants' integration – information, consultation or participation – and informs the inhabitants constantly
- Continuity and a high degree of social competence in the project team and among the contact persons decrease conflicts
- Preliminary talks with inhabitants provide to the success of the renovation process

download:

([http://download.nachhaltigwirtschaften.at/hdz\\_pdf/leitfaden\\_sanierung\\_pro.pdf](http://download.nachhaltigwirtschaften.at/hdz_pdf/leitfaden_sanierung_pro.pdf))

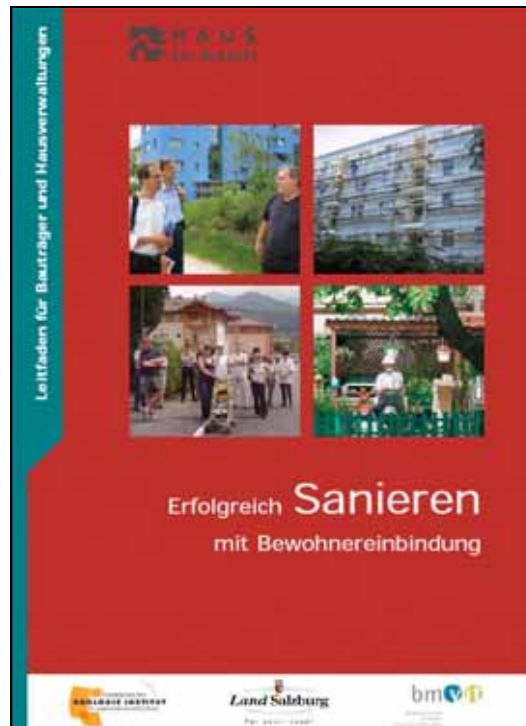

picture 1 - Cover of the brochure of the project Sanierung PRO1,

One recommendation of the project is to establish a 'builders academy' as possibility for institutionalized exchange of experiences between builders.

#### Target group politics and administration

- Flexible models of housing subsidies dependent on basic conditions
- More flexible time periods for housing subsidies
- The requirement of 100 % agreement of inhabitants must not be an exclusion criterion for good renovation concepts
- Cushioning of social severities by combining subsidies for objects and subjects in the context of renovation measures (also of individual measures)
- Subsidies and grants for necessary pre-enquiries (in regard to built volumes, inhabitant structure) as well as process costs of inhabitants' participation (e.g. external consultation).

#### 5.2.3 Cooperative Refurbishment

In this project a model of user participation – for owners and tenants – in advanced renovation of multi storey buildings was developed. In addition demands of inhabitants during renovation processes in multi-storey buildings were studied and exemplary participation processes in renovation projects were implemented. Extensive renovation processes in Austria require the legal consent of residents. This is particularly true for energetic and ecological improvements. An early and systematic involvement of inhabitants could help to avoid many problems concerning the lack of support for extensive renovation often encountered by project managers. User participation can also be seen as a chance for inhabitants to actively evaluate their own residential environment. This usually results in high acceptance and identification with the chosen solutions. But also extensive forms of participation do not guarantee the implementation of sustainable concepts. Three main arguments for participation in planning processes are called for:

One result of the project was a guideline – available in German – to support builders, planners or consultants in the organization and monitoring of inhabitants' participation in renovation processes of multi-story buildings (picture 1).

More information at <http://www.hausderzukunft.at/results.html/id3814>

- Legitimation

Through a broad process of opinion-forming it is guaranteed that the interests of occupants are taken into consideration and decisions are democratically authorized.

- Efficiency

People are experts of their everyday life. Considering this knowledge in planning processes can help to avoid objections or changes later on.

- Identification

Informing and integrating occupants in an early stage of planning processes may contribute that people accept and identify with the results.

### Groups of actors

In multi-storey buildings different groups of actors are involved in renovation processes. The project characterizes the most important participants and their roles as follows

- Housing companies: In the first place housing companies must be willing to include occupants in the process of renovation.
- Occupants (owners/tenants): At least a certain number of residents are usually interested in selected questions. Offers to participate in planning processes have to be agreed upon the residents' needs in regard to the dimensions space and time.
- Building companies: Beginning of construction works is not the end of residents' participation. Professional contact with residents during the construction phase, responding flexibly to wishes and needs, is an important part of renovation processes.
- Social environment: Surrounding neighbours are also important in renovation processes. It is necessary to minimize the inconveniences for the neighbourhood and to inform neighbours about phases of the construction process.
- Subsidising institutions: In Austria institutions that are financially supporting the renovation project are also involved in the building process. They can influence the arrangement of the renovation processes via general guidelines.

Housing companies have to move within prescribed legal framework.

In Austria the residential property law ('Wohnungseigentumsgesetz') and the non-profit housing act ('Wohnungsgemeinnützigkeitsgesetz') define certain proceedings, which must be kept, e.g. duties to supply information, holding of information meetings in regular intervals, execution of inquiries and votings with the occupants or complying with terms.

### Four levels of participation

The project developed a model which offers residents possibilities for participation in all phases of the renovation. Based on Wilcox (1994) the project team distinguishes four levels of participation:

- Information: a one-way-communication from the housing company to the residents of a building to be renovated.
- Communication: At this level of participation a two-way-communication is established, a dialogue between residents and representatives of the housing companies or the facility management occurs; questions can be asked and answered reciprocally.
- Co-design: At this level residents can participate actively, they have the possibility to grapple with certain questions concerning the renovation process. Concrete ideas and solutions are being developed. The question, how results enter the planning process in reality, is open. A possible disadvantage of co-design can be the exclusion of less involved or less active residents.
- Co-decision: At the level of co-decision occupants really take responsibility. The project team distinguishes between collective and individual options of co-decision. The second one refers to changes in single apartments whereas collective co-decision deals with questions, that refer to larger units, e.g. the whole building.

### Flexible model of participation in different phases of the renovation process

The model developed within this project is kind of a tool kit. Elements and methods for different phases of renovation processes and levels of participation can be chosen, applied and combined. Suggestions for possible methods for inhabitants' participation along the different phases of a renovation process are:



- 1 First decision

Written information shall be given to residents, excursions to retrofitted buildings can be offered (picture 2), workgroups or round tables can be installed. Further methods are talks and interviews with occupants, the edition of special house-newspapers or information via internet. Also cost intensive participation methods like future conferences or citizen juries could be applied for large projects. At a future conference participants selected from all interest groups affected draw up programmes and action plans for forthcoming projects in line with a predetermined schedule. In a citizen jury individuals selected at random draw up a 'citizens' assessment' – or in case of a renovation process an 'inhabitants' assessment' of a particular issue, based on their own experience and knowledge. Experts provide assistance for specialized aspects. For the duration of the citizen jury participants are released from their everyday obligations. More information on participatory methods can be found at [www.partizipation.at/methods.html](http://www.partizipation.at/methods.html)



picture 2: During excursions to existing passive house projects inhabitants can inform themselves about new technologies

- 2 Stock check of the building

Occupants can be included in building inspections. They can be invited to evaluate and assess the building and to make suggestions for improvement.

- 3 Rough planning

Information and communication are of special importance. Methods are residents' meetings or workshops with experts that give information on renovation variations. Also small workgroups and focus groups can be established. In a focus group 8 to 15 persons take part in a chaired discussion on a predetermined topic; this can lead to the development of a cohesive group view. The method originated in the field of market research, where it is used to test products and advertising strategies.

- 4 Detailed planning and call for tender

Cooperation with and of occupants is possible in form of a residents' advisory board. The board can be included in important decisions like selection of building companies.

- 5 Phase of decision

In this phase especially methods for decision and voting processes will be applied, like written questionnaires or meetings with occupants.

- 6 Construction phase

An occupants' committee to accompany and control construction works can be installed. Furthermore the on-site presence of the housing company and the availability of its contact persons are very important, This can be reached by establishing an on-site-office, regular consultation hours combined with good information and communication policy. The above-mentioned residents' advisory board and occupants' committee can be very important in this stage of renovation as well. At the end of construction works celebrating can be recommended as a good method.

- 7 Phase of reflection

At the end of a participatory renovation process occupants should be allowed to control the costs. An evaluation about what has been done well and what could have been done better in the process is a good conclusion of the process.

During renovation processes housing companies have to move within the legal framework and must therefore offer prescribed ways of participation. E.g. they have the duty to supply information, to hold information meetings in regular intervals, to make inquiries and a voting with occupants or observe deadlines. The project shows further possibilities to enhance participation in renovation processes, e.g. moderation, inspections, excursions, check lists for occupants, focus groups. These methods can be selected and applied depending upon situation and basic conditions.

More information at <http://www.hausderzukunft.at/results.html/id2819>

5.2.4 PARTI-SAN

The full title of this project is 'Facilitated decision-making procedures for sustainable renovation of residential properties

– Participation in the renovation process'. Concrete renovation projects were monitored and guidelines to optimise planning, information and decision-making processes during the renovation of residential properties were developed.

In practice the reasons for a failure of renovations in residences that contain freehold flats / condominiums can often be explained through lack of acceptance or different opinions amongst the owners, rather than through barriers of technical or financial feasibility. Inadequate procedures of planning, information and decision making are barriers for the implementation of comprehensive, innovative and sustainable renovation of residences.

Important points for the integration of sustainable aspects in the renovation process are:

- cost efficiency for the implementation
- saving effects through the renovation
- user orientation
- improvement of living comfort for the residents

The project comes to the following conclusions:

- A high percentage of 'non-voters' hampers a decision in favour of an advanced renovation; therefore it is important to mobilize residents.
- Residents need appropriate and comprehensive information.
- Professional third party moderation and consultation for the residents meeting can be crucial, e.g. if there are existing conflicts among or with certain residents or if the building managers' basis for discussions with residents is not so good. In Austria usually the property management moderates the assemblies and one has to be aware that it acts in a double role. The important thing is, that questions and problems of residents are taken seriously.
- An adequate framework for the residents' meeting can be a benefit for decisions in favour of an advanced renovation, e.g. an informative invitation as an incentive to participate or a thoroughly planned agenda of the meeting. Also opportunities for visualization may be of help.

- In Austria the programme klima:aktiv 'wohnmodern' [www.wohnmodern.klimaaktiv.at/](http://www.wohnmodern.klimaaktiv.at/) (information in German) offers a rough analysis consulting package for house owners and communities of residents, e.g. the participation of independent experts at residents' meetings. The participation of external experts can be a good measure to convince residents.

More information at

<http://www.hausderzukunft.at/results.html/id2806>

### 5.2.5 Experiences from demonstration projects

Additional experiences with residents' participation in renovation processes have been made within two demonstration projects,

#### Renovation of the multi-storey-building 'Makartstraße' in Linz

During the planning phase information was given to residents through organised meetings with presentations and discussions. A high grade of acceptance for the project from all tenants could be reached. Shortly before the renovation was finished another meeting with tenants was held, where the way of living in a passive house was explained once more. People had the opportunity to exchange experiences. Another research project ([www.zuwog.at](http://www.zuwog.at)) even gives the recommendation to make trainings with inhabitants as far as new technologies like ventilation etc. are concerned.

In the project Makartstraße the extra costs of the renovation could be held low because of housing subsidies for the renovation based on the passive house concept from the Federal State of Upper Austria ('Oberösterreichische Wohnbauförderung') and with additional support from 'Building of Tomorrow'. There were no additional monthly charges for the tenants. Thus a very high acceptance of the renovation project could be reached.

More information at

<http://www.hausderzukunft.at/results.html/id3951>

Demo project brochure of Task 37

<http://www.iea-shc.org/publications/downloads/task37-Linz.pdf>





**picture 3:** Celebrating together after finishing the renovation work is a very important milestone for residents and project owners.



**picture 4:** In the project in Klosterneuburg/Kierling inhabitants were informed very well and several meetings were held.  
source: Architekt Reinberg

### Renovation of the multi-storey-building 'Klosterneuburg/Kierling'

Construction works for this renovation projects were still pending in July 2009 due to objections of neighbours. Nevertheless the planning phase has been finished with extensive participation of residents. The project team worked with tenants in one-to-one-interviews in individual sessions, information about costs, increase of monthly charges and the timetable of works and exposures to noise, dirt, limited access during building work has been given to the tenants (picture 4). An excursion to a multi-storey building that had been renovated to passive-house-standard took place in 2006. Participants could visit two apartments of the refurbished building and talk with inhabitants in a meeting organized in an inn afterwards.

Once the work on the site will start, further measures are planned like

- information and one-to-one-sessions to individual adaptations – e.g. tenants can make an agreement with the housing company BUWOG and arrange individual renovation wishes with skilled craftsmen working at the site (at lower costs than usual)
- organisation of tenant-meetings with planners and responsible persons
- compensation in the height of the rent of one month during the construction time
- support and information for tenants during construction time.

More information at

<http://www.hausderzukunft.at/results.html/id4559>

Demo project brochure of Task 37

<http://www.iea-shc.org/publications/downloads/task37-Kierling.pdf>

### 5.2.6 Conclusions

Increasing the rate of advanced housing renovation is an important goal in regard to climate protection. A lot of objects to be refurbished are inhabited by tenants or owners. In this context the legal framework for renovation processes is very important. In case of residential properties it is impossible to realise an advanced renovation process without acceptance of the owners. One way to reach acceptance of many occupants are financial incentives for renovation measures. Another important focus can be user orientation and the inclusion of all relevant stakeholders in the renovation process. The mutual dialogue of the project consortium on the one hand – from developers to the craftsmen – and inhabitants on the other hand can be a key to successful housing renovation. Advantages of renovation measures and new technologies can be shown and explained. Information and decision processes become more transparent. The knowledge of inhabitants can be of great use in the renovation process. If inhabitants see their needs and wishes considered in the planning and construction process they will more likely accept the whole concept and following inconveniences during the construction period. Thus user participation in renovation processes can lead to a win-win-situation for everyone.

#### Author

Claudia Dankl  
Österreichische Gesellschaft für  
Umwelt und Technik  
[claudia-dankl@oegut.at](mailto:claudia-dankl@oegut.at)



This chapter is carried out in the framework of the Austrian participation in the Energy Technology Programme of the IEA and funded by the Austrian Ministry for Transport, Innovation and Technology.

1.2 Einsatzmöglichkeiten solarthermischer Systeme in Sanierungen

Originaltitel:

Implementation of Solar Thermal Systems in Renovation

Mach, Heimrath, Heinz, Dröscher Müller, Fink

From the economic point of view the solar thermal applications are economically competitive with other energy forms, especially because in all Austrian federal states the acquirement is aided by the public hand ([3], page 45). Rapid market increases could be recorded in the field of solar combisystems. In 2008 about 62% of the new installed systems are used for domestic hot water and space heating and only 38% were carried out solely for preparing domestic hot water. Solar thermal systems are already standard in many new buildings in Austria, even the percentage of implementation in the course of building renovation is increasing. In 2008 already 30% of the new installed collector area was integrated in buildings as part of renovation measures (picture 1).

5.3.1 Approach

This chapter deals with the implementation of active solar thermal systems in building renovation. It references to miscellaneous experiences and research findings with a special focus on the results of the Austrian research programme "building of tomorrow":

More information at:

[www.hausderzukunft.at](http://www.hausderzukunft.at)

Austria traditionally makes strong efforts to implement the thermal use of solar energy in the building stock. Due to a study of AEE INTEC (Institute for Sustainable Technologies) in Austria there was a total capacity of 251.9 kW<sub>th</sub> per 1000 inhabitants of glazed flat-plate and evacuated tube collectors in operation at the end of 2007 ([35], figure 5). This means that Austria comes third in the world (behind Israel and Cyprus) concerning the installed solar thermal power in relation to the number of inhabitants. The Austrian standing is documented impressively with the market enquiry [1] carried out every year on behalf of the Austrian Federal Ministry of Transport, Innovation and Technology (BMVIT [4]).

Due to this report the development of the solar thermal collector market in Austria is characterized by a strong increase of the sales figures of 25% in 2008. In this year 362,923 m<sup>2</sup> solar thermal collectors were installed, which corresponds to an installed thermal power of 254 MW<sub>th</sub>. 95% of the installed solar thermal collectors were glass covered collectors for water heating and space heating. Considering the technical life span, in the year 2008 approx. 3.96 million m<sup>2</sup> of solar thermal collectors were in operation which corresponds to a thermal power of 2775 MW<sub>th</sub>. For this reason Austrian solar thermal collectors produced 1,330 GWh<sub>th</sub>, which causes a reduction of CO<sub>2</sub>-emissions of 545,150 tons. The export rate of solar thermal collectors was 79.8% in 2007. The turnover of solar thermal industry was measured with 590 million Euros for the year 2008. Therefore approx. 7,400 full time jobs can be numbered in the solar thermal business ([3] page 3 and page 4).

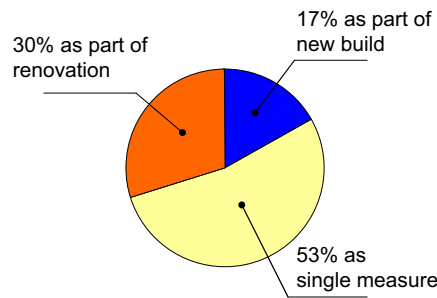

picture 1

Implementation of solar thermal systems in the Austrian building stock, related to the installed collector area in 2008 (362,923 m<sup>2</sup>) (data source: [3], page 43)

focusing the observation layers

Due to the importance of the use of solar thermal heat in new buildings the ambition to implement these systems in the renovation of buildings is the obvious next step of the ongoing development. To describe the different approaches and their obstacles in utilizing solar thermal energy in building renovation this chapter is structured by the concept of areal focusing the observation layers, which are, in a downsizing perception: region, settlement, building and component (picture 2).

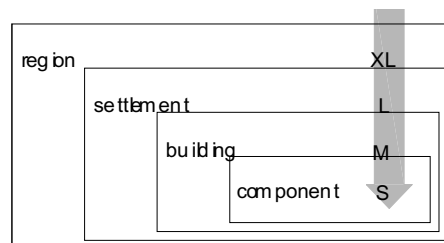

picture 2

Concept of areal focusing the observation levels for the implementation of active solar thermal systems

5.3.2 XL - Region level

The transport of thermal energy always causes losses, long routes of transport should be avoided and therefore regional concepts should be preferred. Local demand of thermal

energy should be preferably covered by local supply of solar thermal energy. Currently a project named "ReCO2NWK" deals with this topic. Further information can be found in [28].

The principal idea behind this project is the development of a tool to meet a region's energy demand with locally available energy resources. Therefore a GIS (geographic information system)-based model has to be designed that can be used as a tool for estimation of possible coverage of the heating and cooling demand of a certain area with the local energy resources of solar thermal heat, geothermal heat and biomass (picture 3).

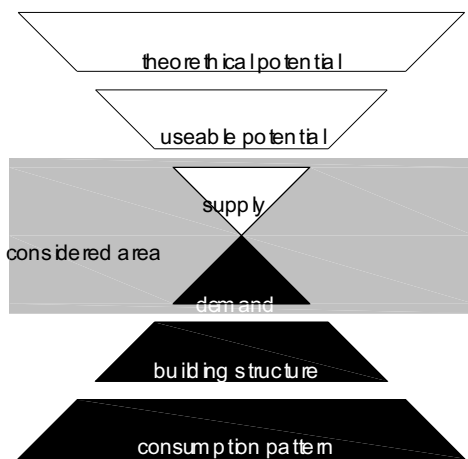

picture 3: Selected workflow approach

### 5.3.2.1 GIS-based model of test regions

For the development of the model, two test regions in Styria, Austria have been chosen: the district of Murau, which is located at the border of the Alps, and the districts of Feldbach and Radkersburg that are located at the foothills of the Alps. These two test regions are related by means of their size, but they differ significantly regarding their topography and consequently their settlement and population structure. These spatial characteristics have a strong impact on both the structure of the energy consumption and the local energy resources, therefore the comparison of these two regions was considered especially interesting.

Because of the different structures of the test regions, the model has to deal with different boundary conditions for each region which has the advantage that the transferability of the model to differently structured regions is evaluated at an early stage. For the spatial model, a grid with 250 m cell width is applied on the investigation area. For each cell, the current energy demand for space heating and cooling,

domestic hot water preparation and process heat per month is determined as well as the local potential to cover this demand with solar thermal heat, biomass, and geothermal heat (by the use of a heat pump). A monthly resolution is chosen for the model since both, the demand and the potential, differ strongly in the course of the year.

For each cell and each month, the results of the demand model and of the potential model are then opposed to each other and the possible coverage of the energy demand with local resources can be derived. As the model is GIS-based, the spatial context of the cells persists and the cells can be clustered in order to arbitrarily expand the area that shall be evaluated by means of its local energy resources. For the modelling of the energy demand, the building stock has to be evaluated both by means of its structure (geometry, insulation) and its energy supply and distribution system. Information about the energy supply and distribution system is crucial because the factor between net energy and final energy strongly depends on it.

The potential of local energy resources can be defined in different ways since it is always a matter of technical, economic and also legal restrictions. For example, protection forests must not be used for biomass production, the installation of a solar thermal system too far away from the consumer is not reasonable (the same applies for a heat pump), neither the installation of e.g. a heat pump in a building with an inappropriate heat distribution system. Then the spreading of a certain technology is also dependent on the price development of the competing technologies and on the other hand it may be pushed with subsidies. For these reasons, costs have also to be considered in the model in order to provide a tool for creating realistic scenarios of energy supply. Another aspect of interest is the CO<sub>2</sub>-balance that results from the different scenarios. When a CO<sub>2</sub>-equivalent is assigned to each energy source and technology, this balance can also be calculated.

### 5.3.2.2 Solar thermal potential of a region

For the modelling of the local energy potential, several parameters have to be considered. For example the theoretic solar thermal potential of a cell is assumed to be the total global radiation on the sloped surface (the angle depends on the application either for only domestic hot water preparation or for a solarcombi system) within one cell (picture 4). This value is only dependent on the geographic location of the cell.

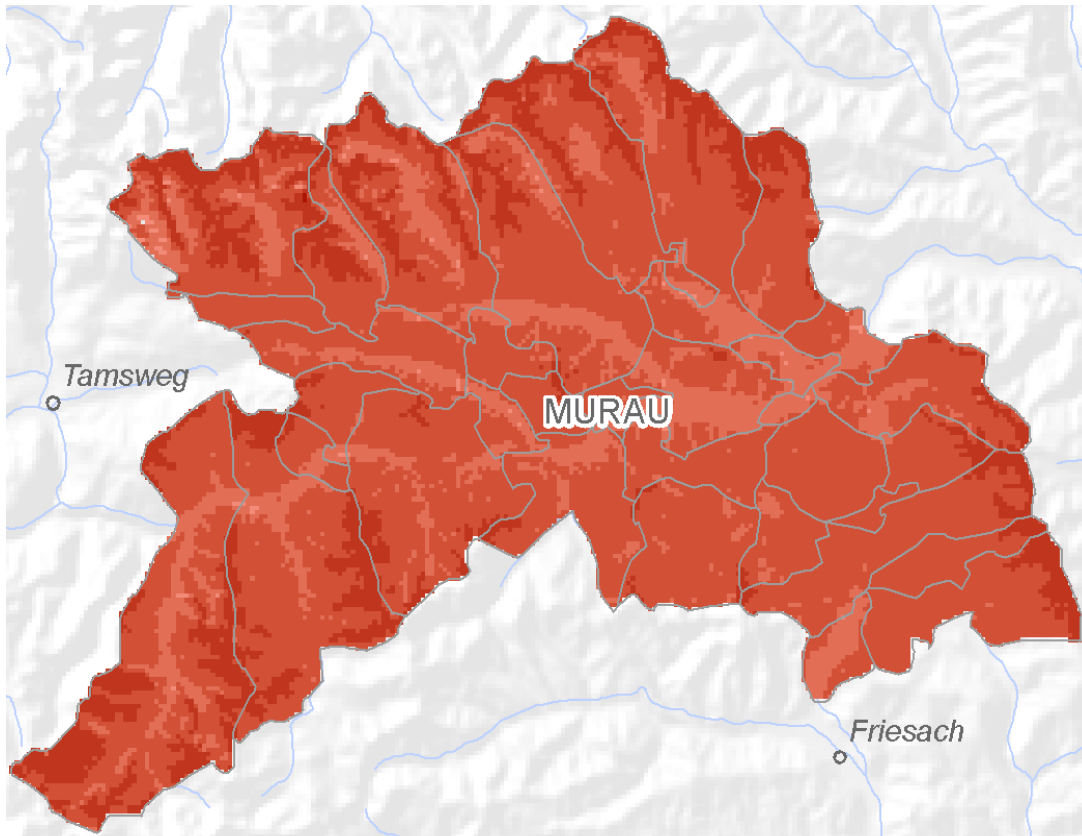

picture 4

Theoretic and usable solar energy irradiation potential of test region Mura, image source [28]

**theoretic solar energy potential**

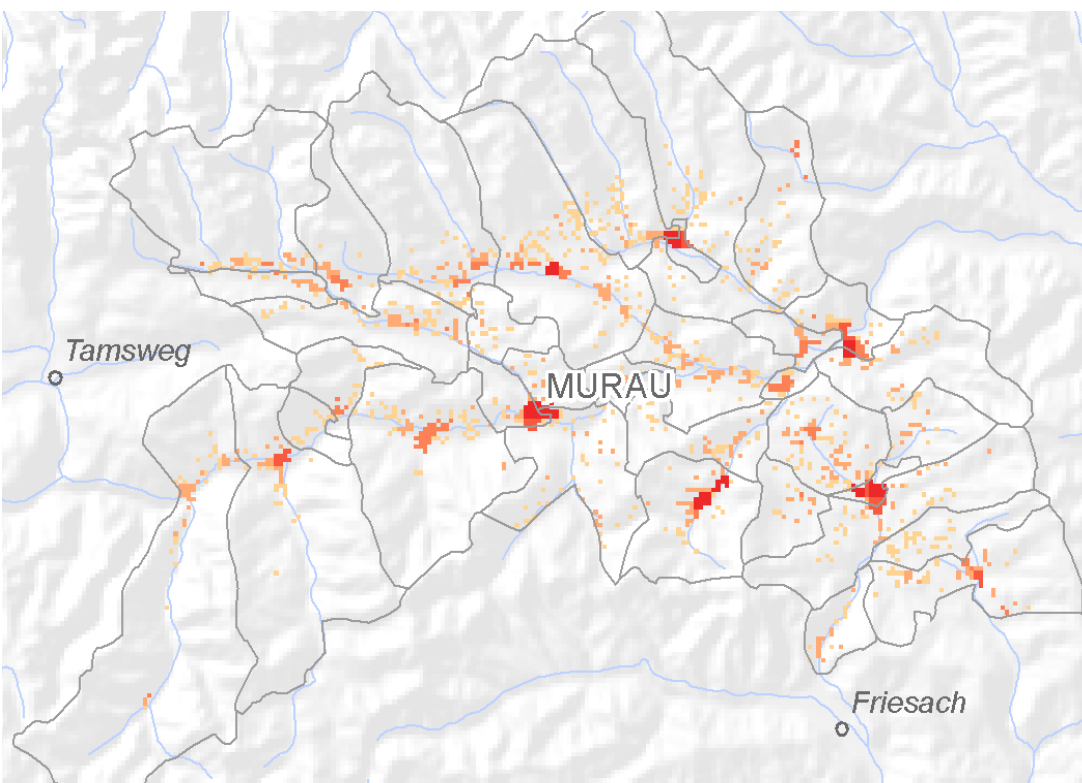
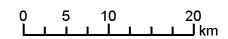
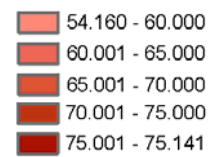

**usable solar energy potential**

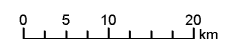
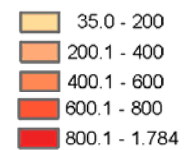

The spatial information is stored in the GIS and out of that the monthly sum of global radiation can be calculated. This can be done according to the climate model described in ÖNORM B 8110-5 [15], or based on the climate data provided by the World Radiation Data Centre [36]

or measured data can be used as well. For the useful solar thermal potential, the useable area is narrowed to suitable roof areas (which corresponds to the restriction named above regarding the distance between the place of energy production and the consumer).



In order to make the result from the potential model comparable to the result from the demand model (the net energy demand), the useful thermal potential is further reduced by a system efficiency factor. This factor is strongly dependent on the system configuration, however, it may be assumed to be constant for a first rough estimation. In the same manner, the local potential of biomass and ambient heat can be evaluated. With this approach it is possible to estimate the feasibility of covering the heating and cooling demand of a region with local resources of renewable energy and to figure out scenarios both of the demand and the potential that regards possible future developments of a region. Measures (e.g. subsidies) can be planned and their effect on the demand and the useable potential can be estimated.

### 5.3.3 L - Settlement level

Thinking about implementation of solar thermal use in the district heating of settlement structures first the question about locating the collector fields and storage systems are arising. The corresponding concepts can be divided in concepts organized centrally and concepts organized semi centrally.

#### 5.3.3.1 Centrally organized solar aided district heating

In the last decade in Austria hundreds of centrally organized biomass fired district heating networks have been installed. One basic challenge with regard to such systems is the operation during summer time, when the heat demand is reduced to the domestic hot water preparation (in most cases about 5-10% of the design capacity). This reduced heat demand leads to high specific net losses, which cause high specific emissions and costs. One way to overcome this problem is the implementation of a solar thermal system.

For constructors and operators of district heating networks and for the funding agencies, the question arised, under which circumstances the combination of solar thermal energy and biomass fired boilers makes sense from an economical and ecological point of view compared to other concepts, which have to provide heat in summer without solar thermal supply. The research project "Solar Assisted Heating Networks" was focused on this question. Further information can be found in [29].

Within the project centrally organized solar aided district heating systems were analysed. These systems consist of one or several central field(s) of thermal collectors connected to one

central storage system and one central system for auxiliary heat production. These centrally positioned components supply the heat demand of the joined buildings through a network of pipes. An example for the adding of a solar thermal system to an existing biomass district heating system can be seen in picture 5 and picture 6.

In this research project a criteria check list for

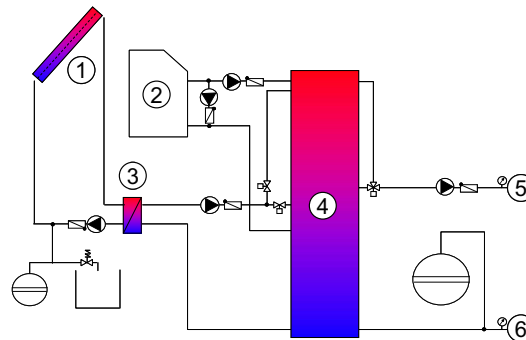

picture 5

*Hydraulic integration of solar thermal components in the district heating system in Eibiswald, image source: [29]*

- 1 ... thermal collector
- 2 ... biomass boiler
- 3 ... heat exchanger
- 4 ... water heat store
- 5 ... supply pipe
- 6 ... return pipe



picture 6

*Mounting of large scale collector modules in the district heating system in Eibiswald, image source: S.O.L.I.D [31]*

system attributes was developed. Depending on the plant size, the plant design, the type and amount of subsidies and other system attributes, the criteria check list offers an economic and environmental assessment. This can be used for a decision-making, whether the considered combination of biomass boiler and solar thermal heating system is economically and ecologically competitive.

The results of the project are based on an extensive data acquisition for biomass local district heating networks with and without solar plant in Austria and thermal simulations of four reference systems with different configurations, heat loads and sizes in numerous scenarios. Subsequently an economic analysis was carried out using the annuity method according to VDI 2067 [34]. Beside manifold calculation results the following findings were obtained.

**Heat load density** - In the course of the data acquisition detailed data of 65 district heating plants could be obtained.

The results showed that the total investment costs of a district heating network are highly dependent on the heat load density (heat demand compared to the length of the heating network). It was, however, stated that a majority of the district heating networks have a low heat density of partly far below 1000 W/m.

**Return temperature of the network** - For the economy of a combination of biomass and solar plant low return temperatures, which allow high specific energy savings by the solar system, are an advantage. It was also found, that the summer operation with a solar plant is economically competitive in comparison to a summer operation with an oil boiler, which is often done in Austrian biomass district heating plants. With regard to a summer operation with biomass fuels the result depends strongly on the kind of biomass used in the respective case.

**Size of boiler** - The implementation of solar thermal systems in the centrally supplied heating networks allows a significant reduction of the primary energy consumption. Regarding the emission savings potential there is a high dependency on the respective boiler dimensioning, due to the increased emission output of boilers in cycling operation, which was considered in the calculations. [29]

Summarising it must be said that the thermal rehabilitation of the in such a way supplied building stock lead to a decreased heat density and therefore a reduced operating efficiency. If, however, a complete thermal rehabilitation of the entire service area can be reached, the supply temperatures can be reduced and a higher fraction of solar coverage can be achieved.

#### Example for realisation of solar thermal energy in a district heating network

In 2002 in Graz the first solar feed-in of solar thermal energy in a district heating network was brought on line. The collector field (1,407 m<sup>2</sup>) is mounted on the roof of a skating hall (picture 7). The plant is operated by means of contracting. In 2008 a second solar feed-in was finalised at the premises of the waste disposal and recovery GmbH (AEVG) and the adjacent district heating power station Graz-Süd (picture 8). The largest solar array in Central Europe (4,062 m<sup>2</sup>) is placed on four separate roofs. In 2009 a third solar thermal direct feed-in of solar thermal energy into the district heating grid of Graz was brought on line (picture 9). The 3,855 m<sup>2</sup> collector field is combined with a water heat store (heating support utility) of 64.6 m<sup>3</sup>. The described facilities were designed and constructed by the company S.O.L.I.D [31].



Collector area: 1407 m<sup>2</sup>  
large scale collectors  
application of energy: about 540 MWh/a  
Commissioning: 2003

picture 7

First facility for feeding-in solar thermal heat in the district heating network of Graz,  
image and data source: S.O.L.I.D [31]



Collector area: 4062 m<sup>2</sup> (2008)  
Planned enlargement up to 6903 m<sup>2</sup>  
application of energy: about 1,800 MWh/a  
Commissioning: 2007-2008

picture 8

Second facility for feeding-in solar thermal heat in the district heating network of Graz,  
image and data source: S.O.L.I.D [31]



Collector area: 3855 m<sup>2</sup> (complete assembly in 2010)  
Store volume: 64.6 m<sup>3</sup>  
district heating feed-in and heating support  
Commissioning: 2007-2008

picture 9

Third facility for feeding-in solar thermal heat in the district heating network of Graz,  
image and data source: S.O.L.I.D [31]

#### 5.3.3.2 Semi centrally organized solar thermal aided district heating

In densely populated areas, the net-bound heat supply plays a decisive role. In urban areas long distance heating systems are common. In areas with a rural characterisation rather local district

heating systems are favoured. Small versions of local district heating systems, so called micro networks show a high potential for efficient heat supply of small area settlements. If these networks are based on renewable energy sources (biomass and solar thermal) they could, compared to individual supply, make a significant contribution to the reduction of CO<sub>2</sub> emissions in the sector "space heating and domestic hot water" and additionally offer an increased level of supply guarantee. Micro networks can be used for new housing estates as well as for settlements to be renovated.

### Difficulties of implementation

Despite their apparent potential they could not be established as a standard heat supply system in Austria in the last few years. The attempt to find an explanation for this development leads to technological, economical and organizational obstructions concerning the implementation of micro networks. Typically a new build settlement is realized step by step in several implementation phases. In many cases the construction is a process which could last a couple of years, up to decades. The heat engineering and regulatory requirements could change several times. According to this, the supply system has to be constructed in a modular and adaptable structure. The project "Heat supply of development areas through supplementary solar supported near heat nets" is focused on the technological aspects of this problem. More information can be found in [18]

The specific objective of the project was to find solutions for efficient network configurations, which work on the base of decentralized load balancing stores and decentralized injection points for solar thermal heat, including the dimensioning of all technological components. Additionally a comprehensive cost analysis for modular heating networks in comparison to decentralized, conventional heating systems had to be done.

The first step was a data search and a survey concerning the current and future anticipated structure of settlements. Based on this preliminary work, three typical settlement areas were defined (picture 10). The colours mark the phase of implementation: red marks the buildings of the first phase, green marks the buildings of the second phase and blue marks the buildings of the third phase.

All three settlements have been simulated by means of a transient thermal model with a combination of the TRNSYS simulation environment [33] and the network calculation program simplex [10].

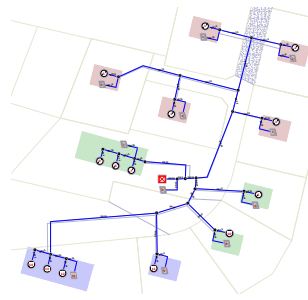

picture 10

Sketches of the developed settlements and grid structures, image source [18]

**Single family house area**  
14 accommodation units  
100 kW heating load

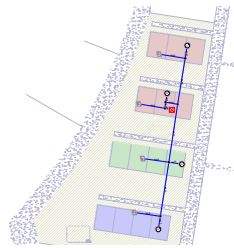

**Multi family house area**  
34 accommodation units  
150 kW heating load

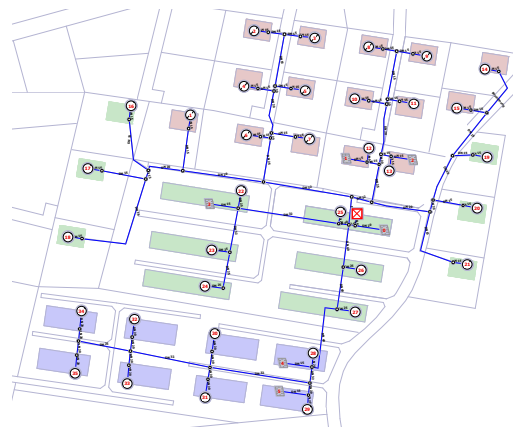

**Mixed area** (multi family houses, row houses and multifamily houses)  
117 accommodation units  
600 kW heating load

Picture 11 shows some basic design figures of the settlement models according the accommodation units, the erection time per phase and some key figures about the grid.

		modell area		
		single family	multi family	mixed
		accommodation units		
		14	34	117
		errection time per phase		
p1	2 years	2 years	2 years	4 years
p2	2 years	2 years	2 years	2 years
p3	2 years	2 years	2 years	2 years
∪	6 years	6 years	6 years	8 years
		length of grid		
		294 m	59 m	1033 m
		installed heating power		
		100 kW	150 kW	450 kW
		domestic hot water and heating demand		
		0.20 MWh/a	0.23 MWh/a	1.00 MWh/a

picture 11

Design proposals to achieve the economic optimum, data source [18]



For these three models of settlements the integration of centralized and decentralized positioned solar thermal collectors in the supply grids was developed, studied and optimized. The following findings were identified:

A minimized return temperature (harmonised with the user), best below 30 °C, is the foundation for an efficient operation.

The thermal losses of the distribution and storage components can be relatively high in relation to the heat consumption for domestic hot water and heating (single-family house area: 34%, multi-family house area 8%, mixed area 21%).

The performance of the pipe insulation is a crucial parameter for the efficiency of the system. The usually used pipe insulations often show a potential for improvement.. Picture 12 shows a cross section of two pipes, analysed due to their thermal losses.

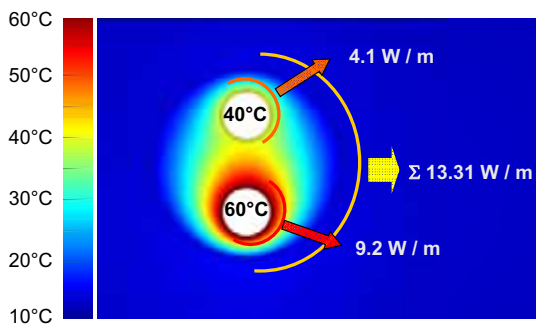

picture 12: Cross section of two pipes, enquiry of the thermal losses of the pipes in the supply network, image source [18]

In addition, the accumulated total costs (Investment cost plus operating costs) for the three designed settlement areas were calculated for a period of 25 years. The calculations are based on the following economic assumptions: The external financing, interest rate was assumed to be 5% and the energy price increase per year was assumed to be 4%. The efficiency of the boilers was expected to be 80-85% depending on the energy source. The maintenance costs were expected to be 0,5% to 1,5% of the investment costs per year.

The calculations were based on the prices of different energy sources and different rates and developments of subsidies. Picture 13 shows accumulated cost for the heat supply in the multi family house area. The economically optimum collector area is given with a solar fraction of about 85% during the summer months.

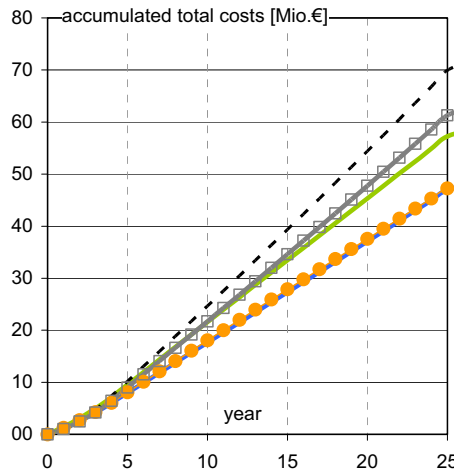

picture 13

Accumulated cost for the heat supply in the multi family house area (data source [18]), assumed prices:

woodchips: € 0.029/kWh,  
wooden pellets: € 0.053/kWh,  
natural gas: € 0.061/kWh,  
oil: € 0.064/kWh

- central supply with woodchips
- central supply with woodchips and solar
- central supply with pellets and solar
- local supply with natural gas and solar
- - local oil supply with solar

Depending on the model of settlement this leads a solar cover of the annual heating and domestic hot water requirement of 13% to 15%. The developed design proposals to achieve the economic optimum in terms of the collector area and the storage volumes are shown in Picture 14.

	modell area		
	single family	multi family	mixed
<b>implemented collector area per phase</b>			
p1	30 m <sup>2</sup>	30 m <sup>2</sup>	-
p2	-	-	180 m <sup>2</sup>
p3	60 m <sup>2</sup>	60 m <sup>2</sup>	180 m <sup>2</sup>
◇	90 m <sup>2</sup>	90 m <sup>2</sup>	360 m <sup>2</sup>
<b>volume of heat storage tank</b>			
	11.2 m <sup>3</sup>	8.2 m <sup>3</sup>	51.0 m <sup>3</sup>
<b>annual solar fraction</b>			
	13%	15%	13%

Basically the results show that an integration of solar thermal systems in micro-networks reduces the total cost, if an expensive fuel is substituted (natural gas, oil). For cheaper fuels (wood chips) the integration of solar energy is expected to be neutral. In matters of ecology the integration of solar thermal energy in micro-networks can always be seen as an advantage.

### 5.3.4 M - building

Even though thermal systems show a far bigger economic potential in the field of renovation the market development of solar thermal systems in the existing building stock is considerably slower than it is in the sector of the new buildings. In comparison to the integration into new buildings some technical and organizational differences have to be taken into account. First the best time of implementation, has to be chosen, then the collectors have to



be integrated in buildings which were originally not designed for this purpose. Finally the implemented system has to be integrated in the existing distribution network (2 pipe net versus 4 pipe net). Basic principles are described in the following.

### 5.3.4.1 Time of Implementation

To keep the investment costs as low as possible, some convenient times have crystallized for the additional integration of solar thermal systems, in which the best time appears for the integration of a solar thermal system within the framework of a comprehensive (total) modernization (upgrading). By an integral consideration the highest possible efficiency can be achieved at comparatively favourable (beneficial) investment costs. The replacement works on the domestic hot water preparation and the heating system or the repair works on the roof (parts of the roof cover can be taken by the solar thermal system) are for example most suitable times. If synergies can be achieved, then the investment costs for the solar thermal system are below or within the same range as in the case of the new building.

### 5.3.4.2 Placing the solar collectors

The integration of solar thermal collectors in the envelope of an existing building leads to two main questions. On the one hand the collector fields have to be integrated in the architectural design concept of the whole building and on the other hand the collectors have to achieve a high energy yield to be economic profitable.

### Construction and visual design

The basic design problem of the integration of solar thermal collectors in existing building envelopes in the course of a renovation is based on the fact that the original design concepts did not include this purpose. When it comes to applications of solar thermal space heating in building renovation projects there are often sufficient and suitable oriented roof areas available for the installation of solar thermal collectors. When installing these on existing roofs or joining them to flat roofs, the plants often form a foreign body since they are not an integral part of the architecture. For this reason solar plants are still rejected by many architects and town planners. To overcome these obstacles the solar industry increasingly provides products to raise the variety of construction possibilities and visual design options. A description to this ongoing development is given in the chapter named "S - Component level".

### Energy gain

The basic motivation to implement solar collectors lies in the gaining of energy. The amount of solar thermal energy that can be obtained is closely linked to the location and position of the collector itself. Picture 15 and picture 16 give an impression of the importance of the placing.

angle	irradiation in kwh/month				
	roof				facade
	0°	30°	45°	60°	90°
<i>south</i>					
jan.	34	60	68	72	68
feb.	54	78	84	86	75
mar.	93	118	122	119	95
apr.	119	130	127	117	83
may	158	160	149	132	82
jun.	160	156	143	124	75
jul.	164	162	150	131	81
aug.	143	153	146	133	90
sep.	102	122	122	117	89
oct.	70	98	105	106	91
nov.	37	62	70	73	68
dec.	28	49	55	59	56
Σ	1162	1346	1341	1268	953
<i>east / west</i>					
jan.	34	33	32	31	25
feb.	54	49	46	43	34
mar.	93	88	83	76	59
apr.	119	113	105	96	73
may	158	149	139	127	97
jun.	160	153	142	129	96
jul.	164	154	143	131	98
aug.	143	133	124	112	84
sep.	102	95	90	83	65
oct.	70	64	60	56	44
nov.	37	33	32	30	24
dec.	28	25	24	23	18
Σ	1162	1090	1020	936	716
<i>north</i>					
jan.	34	14	14	13	11
feb.	54	24	22	21	17
mar.	93	50	33	31	27
apr.	119	85	63	46	37
may	158	126	100	71	49
jun.	160	135	112	85	54
jul.	164	136	112	84	55
aug.	143	106	80	56	43
sep.	102	63	42	36	31
oct.	70	31	27	26	22
nov.	37	16	15	14	12
dec.	28	13	13	12	10
Σ	1162	799	634	494	368

picture 15

*Irradiation on different orientations and angles of incidence*

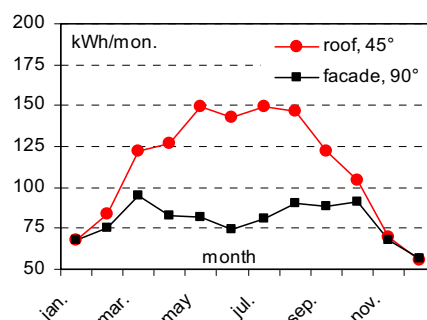

picture 16

*Radiation on a roof versus radiation on a vertical facade, both facing south\**

\* Data source Meteonom [13], climate data of Graz calculated with TRNSYS [33]

It has to be taken into account that the solar thermal collectors are often shaded in some way. Therefore the irradiation that is characteristic for a combination of location, angle of incidence and direction of incidence is reduced. Especially when placing solar collectors in inter-urban areas this aspect has to be considered.

#### Example for the implementation of collectors on the flat roof

The Lower Austrian property developer GEDESAG [7]] focuses not only on integral technical building concepts in the new building. But also in the building stock the use of solar thermal energy is pushed strongly as numerous realized examples of the company show. It is a central request of the property developer in the context of a global building renovation concept that in the course of adaption the building automation also to integrate solar thermal systems into the heat supply.

Besides the integration into the building automation it applies also the building integration of the collectors (saddleback roof integration, flat roof installation, façade integration, design as balcony or parking place roofing etc.) according to the conditions as well as also the resident wishes with maximum energetic efficiency and a nicely shaped implementation. Exemplarily in two projects of the GEDESAG different approaches for the integration of the solar thermal plant were carried out :

In Lower Austria in the city of Krems (Mitterauerstraße) a global building renovation of a multifamily house was done (picture 17). In the course of this renovation (window exchange, flat roof refurbishment incl. insulation, renewal of the heating control centre incl. domestic hot water preparation, elevator installation, Grander water revitalization, outside facilities etc.) a solar thermal system was built for the domestic hot water preparation of the 80 freehold flats.

The collectors are practically not visible for the residents. In this project a combined renovation of the flat roof (erection year 1969) and the installation of the 188 m<sup>2</sup> large solar thermal plant was carried out. The installation of the collector supporting structure could be carried out in the course of the insulation- and sealing work. Another synergy effect with the solar thermal plant erection was given by the installation of the heating control centre (condensing gas boiler instead of old gas boiler) respectively the domestic hot water preparation.



picture 17

188 m<sup>2</sup> collector area at the flat roof of the object "Mitterauerstraße" managed by the GEDESAG, Krems, image source: GEDESAG [7]



picture 18

Altogether 12 m<sup>3</sup> energy storage volume in the heating control centre of the flat roof, image source: GEDESAG [7]

Since the heating control centre is situated at the flat roof and the heat distribution runs from the roof in the direction of the ground floor centrally (four pipe net), the solar energy storage tanks (altogether 12 m<sup>3</sup>) were also put in the attic storey which interfere with effects on the static assessment of the sub-construction (picture 18). The annual solar fraction of the domestic hot water need in the project "Mitterauerstraße" is according to information from the project managers at the GEDESAG about 60%. The specific investment costs for the solar thermal plant are about 550. - €/m<sup>2</sup> collector area, which results in a payback period of about 11 years. The costs for all concluded redevelopment measures amounted to 104 €/m<sup>2</sup> living area in the concrete project with a simultaneous reduction of the original heat requirement by more than 30%.

#### Example for collectors implemented in the façade

A very striking building integration by façade integration was carried out in the project "Admonterstraße". A 90 m<sup>2</sup> solar thermal collector area at the south façade is used for domestic hot water preparation for 30 rented apartments (picture 19).

The main advantages of this kind of integration are the reduced investment costs (as no stilted construction is necessary) and the enforced identification of the residents with the solar thermal heating system.

Disadvantages in form of yield losses (primarily in the summer months) arise at a façade integration because the collector areas are inclined to 90°. A little longer amortization time period (about 16 years) is the consequence in this example. The installation of the solar thermal heating system was embedded in a comprehensive building renovation (window exchange, flat roof renovation incl. insulation, façade insulation incl. balcony renovation, cellar ceiling insulation, electrical installations, outdoor facilities, etc.) in this project (erection year 1969). The complete building renovation costs amounted to 213.-€/m<sup>2</sup> living area.



picture 19: Well designed integration of 90 m<sup>2</sup> of solar thermal panels into the building façade of the object 'Admonterstraße', Krems (image source: GEDESAG [7])

#### Hydraulic integration of solar thermal systems in the course of a building renovation

Depending on the composition of the existing heat production for domestic hot water and space heating (central or decentralized) and the aspired functionality (domestic hot water preparation or solar combisystem) basically three different types for the hydraulic integration of a solar thermal system are given.

##### 5.3.4.3. Solar thermal domestic hot water supply with four pipe net

Building stock (initial position): the object has a central heating supply system for the space heating and domestic hot water preparation (dhw). The heat distribution (room heating and dhw) is carried out via one pipe pair each (four pipe net).

#### Integration of solar thermal systems

The existing domestic hot water system (drinking water storage or a big fresh water module) is extended with an energy storage (at small applications one drinking water storage, at greater applications a buffer storage), which is charged by the solar thermal system. The coupling is simply, economically and in principle always possible. If the solar plant also is integrated in the room heat supply, heat generation and space heating system are also coupled hydraulically to the energy storage (picture 20).



picture 20

Afterwards installed solar thermal system (collector area 320 m<sup>2</sup>) on the flat roof of a housing department in the Hans Riehl Gasse in Graz, supply into the central domestic hot water preparation, image source: S.O.L.I.D [31]

#### Technical description of the solar thermal system

The collector array is connected via an external heat exchanger to a new domestic hot water tank. The solar thermal loop has the possibility to stratify via two different heights into the dhw-tank (depending on the temperature from the solar thermal heating system). If the energy input from the solar thermal heating system is not enough, the existing heating system has to deliver heat with a sufficient temperature. For the optimal operation of the solar thermal heating system it is necessary to think about the best position of inlets and outlets of the dhw - tank. Hot solar inputs, the always hot standby volume and also the inlet position of the dhw circulation pipe should be carefully positioned. For the heat distribution the two existing pairs of pipes are used. The needed temperature level for the space heating pipe pair is depending on the used space heating system (radiator or floor heating) but after a building renovation in the most cases temperatures below 55°C supply and 45°C return temperature must be possible.

The domestic hot water pipe pair requires supply temperatures above 65°C and comes back with return temperatures of about 55°C. With these high return temperatures, this concept can not reach a maximum system performance.

Detailed information's about the solar thermal domestic hot water preparation with four-pipe nets can be found in the projects [29] and [30]. Picture 21 shows a schematic drawing of the described concept.

general installation of the heat distribution system according to the principle of the two-pipe net with tap water stations and apartment internal supply could be useful. The heat distributing losses also could be reduced considerably through this measure.

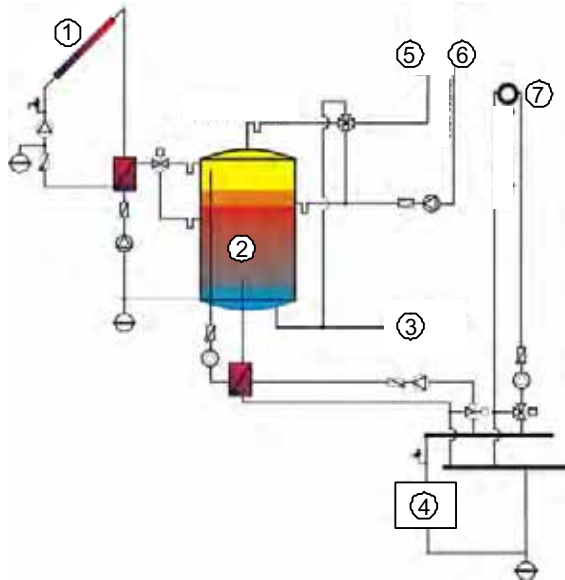

- 1 ... thermal collector
- 2 ... hot water tank
- 3 ... cold water
- 4 ... boiler
- 5 ... hot water
- 6 ... domestic hot water circulation
- 7 ... domestic space heating

picture 21

*Hydraulic schematic of a solar thermal domestic hot water preparation with a four pipe net*

#### 5.3.4.4 Solar thermal heat supply with four-pipe net

Building stock (initial position): the considered object is equipped with a central room heat supply (ascending pipe break through apartment boundary) and about a de-centralized domestic hot water preparation (off peak storage or instantaneous gas-fired heater).

#### Integration of solar thermal systems

The heat distribution system is extended by a thermal energy store (buffer storage) which is charged by the solar thermal system and also by the conventional central heating plant. The space heating distribution is carried out to the apartments via the existing pair of pipes. The domestic hot water pre-paration must be realized over a new pair of pipes (e.g. over the staircase house) in connection with fresh water stations. The existing domestic hot water system (off peak storage or instantaneous gas-fired heater) can be replaced with fresh water stations (domestic hot water preparation in the flow principle) which can be coupled to the apartment internal domestic hot water distribution system with low adaptation work. Besides the possibility of using solar energy these hydraulics also offer advantages with respect to user comfort and water hygiene. If the object is modernized extensively, it has to be checked if a

#### Technical description of the solar thermal system

The collector array is connected via an external heat exchanger to a new energy storage tank. The solar thermal loop has the possibility to stratify into the energy tank via two different heights (depending on the temperature from the solar thermal heating system). If the energy input from the solar thermal heating system is not enough, the existing heating system cares about the temperature specification for the standby volume within the upper part of the energy store (Picture 22).

For the optimal operation of the solar thermal heating system it is essential to think about the right position of inlets and outlets of the heat storage. The hot solar inputs, the always hot standby volume and also the inlet position of the room heating and dhw preparation return pipe should be carefully attended. For the heat distribution one existing (space heating) and one new pair (dhw) of pipes are used. The needed temperature level for the space heating pipe pair is depending on the used space heating system.

Temperatures below 55°C supply and 45°C return temperature are possible. The new domestic hot water pipe pair needs supply temperatures around 60°C and returns with temperatures below 30°C.



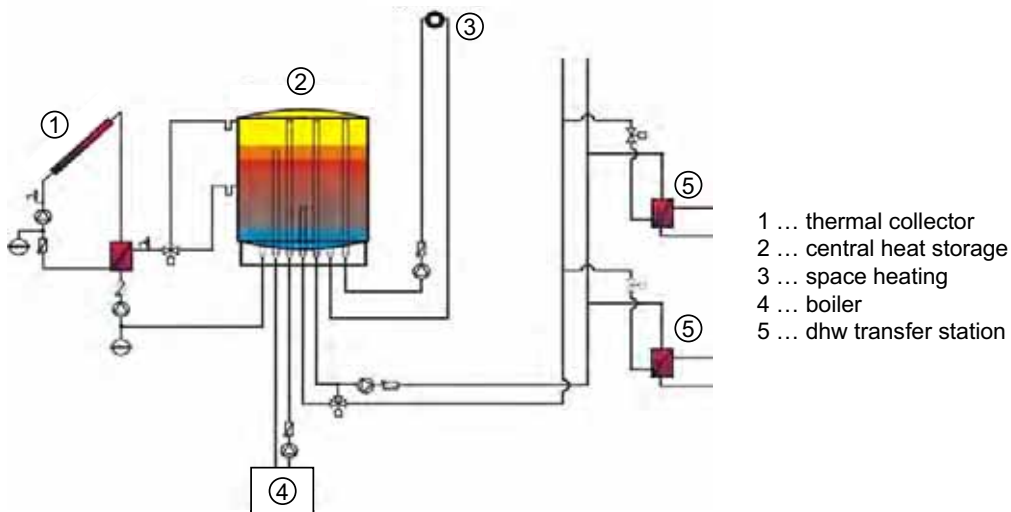

picture 22

*Schematic of a solar thermal heat supply with a four-pipe net*

Temperatures below 55°C supply and 45°C return temperature are possible. The new domestic hot water pipe pair needs supply temperatures around 60°C and returns with temperatures below 30°C. With this low return temperature (dhw preparation), this concept can reach a higher system performance than the concept before. Detailed information's about the solar thermal domestic hot water preparation with four-pipe nets can be found in the projects [29] and [30].



picture 23

*In the course of a complete modernization a solar thermal system (with 164 m<sup>2</sup> collector area) was installed at the Plainstraße (Salzburg). The non-profit housing company qswb [7] realized there the heat supply concept with a two-pipe system with apartment stations (42 flats).*

#### 5.3.4.5 Solar thermal heat supply with two-pipe net

Building stock (initial position): the considered object is equipped with a decentralized room heat supply (individual stoves, heating system covering one floor) and a decentralized domestic hot water preparation (off peak storage, instantaneous gas-fired heater or energy storage in combination with self-contained central heating).

#### Integration of solar thermal systems

Beside the integration of a solar thermal system a switch from a decentralized supply to a centralized heat distribution system will be done. Both, solar plant and conventional heat generation system, charge a central energy storage from which the heat supply (domestic hot water and room heating) is carried out via a two-pipe net, which is newly installed. If the building stock is supplied via a heating system covering one floor, the existing, apartment internal heat distributing system can be used for the room heat supply. If individual stoves (wood, coal, electrical etc.) become substituted, the room heating supply must be installed newly. Picture 23 shows an example for a building modernization including solar thermal heat supply and a two-pipe-net

The existing domestic hot water heater will be replaced by apartment stations or fresh water stations (domestic hot water preparation in the direct flow principle) which can be coupled to the existing internal domestic hot water distribution system with low adaptation work. Besides the possibility of using solar thermal energy, this system also has advantages in terms of user comfort, water hygiene and minimized thermal losses.

#### Technical description of the solar thermal system

The collector array is connected to a new energy storage tank via an external heat exchanger. Picture 24 shows a schematic drawing of the described concept. The solar thermal loop has the possibility to stratify via two different heights into the energy tank

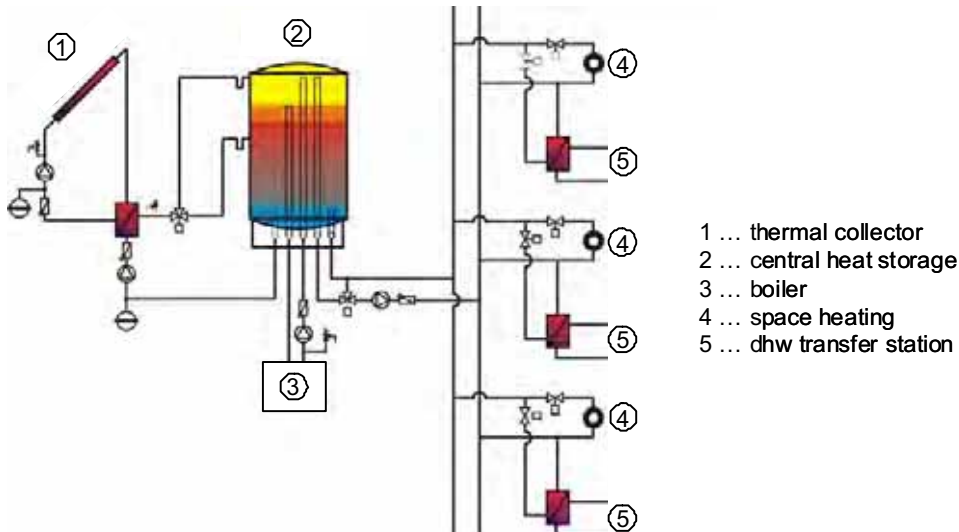

- 1 ... thermal collector
- 2 ... central heat storage
- 3 ... boiler
- 4 ... space heating
- 5 ... dhw transfer station

picture 24

*Schematic of a solar thermal heat supply with a two-pipe net*

(depending on the temperature from the solar thermal heating system). If the energy input from the solar thermal heating system is not enough, the existing heating system care about the temperature specification for the standby volume within the upper part of the energy store (lower part is exclusive for the solar thermal heating system).

For the optimal operation of the solar thermal heating system it is necessary to think about the right position of inlets and outlets of the heat storage. The hot solar inputs, the always hot standby volume and also the inlet position of the return pipe should be carefully attended. For the heat distribution is only one pair of pipes used. The needed temperature level is depending on the used space heating system (radiator or floor heating) but in the most cases 60°C supply and 30°C return temperature.

With this concept it is possible to realize a maximum of solar fraction, because of the low return temperatures into the heat storage (ideal for the solar thermal system). Detailed information's about the solar thermal heat supply with two-pipe nets can be found in the projects [29] and [18].

#### 5.3.4.6 Control and Monitoring

A solar thermal system is designed to work efficiently under certain operating conditions. However, in practice, unexpected conditions may occur and the components will be affected from material aging and fouling. The consequences are lower solar gains and finally, in worst case, the breakdown of the solar thermal system.

In practice, many maloperations and failures in the system remain undetected until the worst case comes to pass. However, the efficiency of the solar thermal system is reduced from the

time the failure occurs and possible solar gains are wasted. The bigger part of those maloperations can be detected at an early stage, when the solar thermal system is monitored and maintained permanently. Annoyance and costs can be saved when the failures are detected and resolved shortly after their occurrence. The reason why the necessary monitoring for early failure detection is usually not carried out is the high time and consequently cost effort for the monitoring task. Until now, no standardized monitoring concept has been established and hence each solar thermal system has to be handled individually.

Within the R&D-project "IP-Solar" [21], an approach to efficiently deal with the monitoring task is developed. The goal is a monitoring tool that has a high automation level but is still flexible and applicable on different solar thermal systems (no commitment to a certain producer or operator).

The basis for a standardized monitoring concept is a standardized hydraulic concept of solar thermal systems. To evaluate common hydraulic configurations, a market analysis of solar thermal systems in Central Europe with more than 80 m<sup>2</sup> collector area has been performed. The focus was set on the hydraulic design as well as on the measuring and the control concepts. Based on this study, standardized modules of a solar thermal system have been defined. Picture 25 shows an example of a solar thermal system for domestic hot water preparation that is built from predefined modules (dashed lines = module boundary).

Thanks to the modular design, differently configured solar thermal systems can be described by assembling the appropriate modules. The second row in picture 25 shows three other variants of the domestic hot water preparation

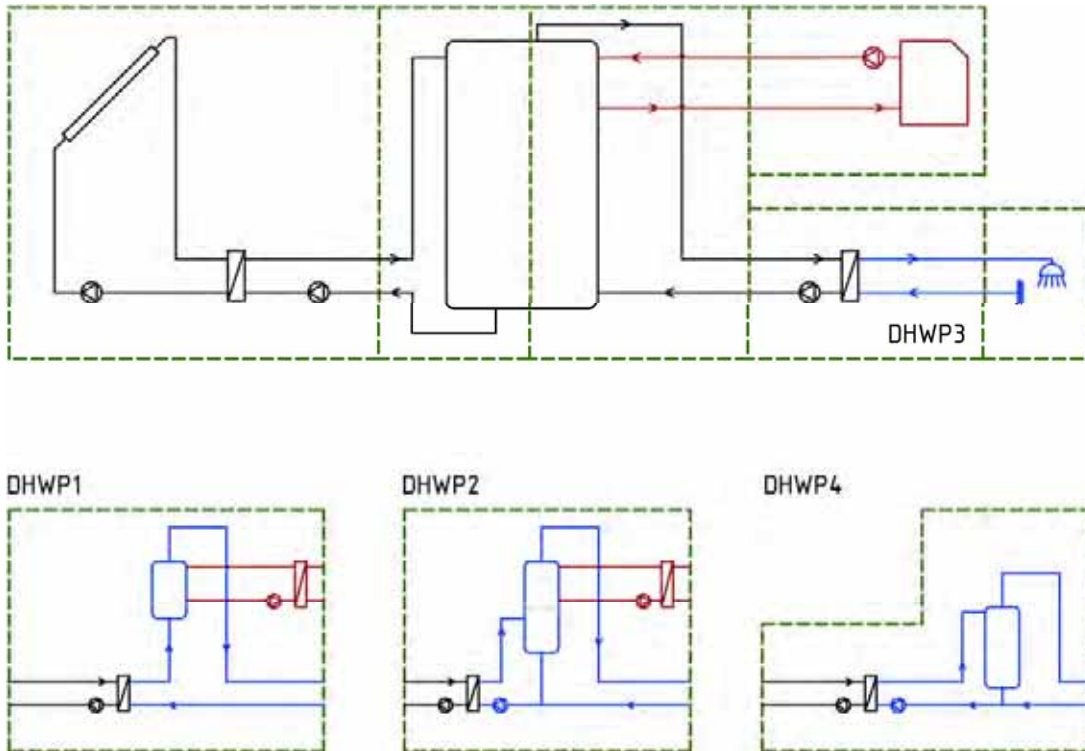

picture 25

Modular design of a solar thermal system for dhw preparation, image source: [6]

module (DHWP) that can replace the module variant DHWP3 in the upper row. For every module, several compatible variants are predefined in a database that is extendable for future developments.

Corresponding to the modules, a recommended minimum measuring concept is defined as well as several other possible measuring concepts. With those prerequisites (standardized hydraulic configurations and measurement concepts), the intrinsic objective, the development of an automated monitoring concept, can be treated.

At present, the algorithms for failure detection and identification are worked on. The monitoring tool is supposed to give assistance in ensuring permanently efficient operation of the solar thermal systems that are conceived in new buildings as well as in renovation projects.

### 5.3.5 S - Component level

With regard to the component level a whole bunch of questions is connected to the intention to comprise solar thermal systems in the renovation processes of buildings. In each project a large variety of components has to be chosen or designed. In the following selected components and several research projects which are concerned with these topics are described.

#### 5.3.5.1 Constructional integration of solar thermal collectors

Pertaining to the integration of solar thermal collectors in to be renovated building envelopes the constructional integration must be solved. In case of placing the collectors outside the thermal building envelope fixed with self-contained mounting systems basically mechanical requirements for the collector and the fixing system have to be fulfilled. Examples for this are the mounting outside on a steep roof close to the roof covering (picture 26), elevation on the top of flat roofs (picture 27) or the mounting of the solar thermal collectors on open adjoining buildings like car ports (picture 28).



picture 26

Fixing of a solar collector close above the roof tiles of a steep roof, image source: GREENONETEC [8]





picture 27: 202 m<sup>2</sup> collector area on a roof of a multifamily building in Vienna (Erlaaerplatz), 200 apartments, 10 m<sup>3</sup> heat store, image source: S.O.L.I.D. [31]

outside. But this disagrees with the covering of the collector which is made of glass and therefore nearly impenetrable for vapour. For this reason a gap between the collector and the wall provides air ventilation which is removing moisture. The disadvantage lies in reduced heat protection of the construction because of the ventilation. During the heating season in not ventilated constructions the heat losses are reduced because of the higher temperature in the collector. On the other hand this leads to heat transfer to the interior room. This effect could cause increased temperatures or cooling loads in the interior room in the cooling season. Picture 29 shows a typical example for the implementation of big scaled solar collectors in renovation projects of apartment houses.



picture 28: Solar thermal collectors build as outdoor car roofing for an apartment building in Graz (Grottenhofstrasse), image source: ENW Ges.m.b.H. [31]



picture 29  
Mounting of integrated solar collectors on the roof of an attic conversion in Graz, image source: Eduard Wasserfaller



When installing collectors on existing roofs or joining them to flat roofs, the plants often form a foreign body since they are not an integral part of the architectural design. For this reason solar thermal plants are still rejected by some architects and town planners. For a wide market penetration it is, therefore, necessary to use collector systems which allow the integration of the collectors in building envelopes (roof or façade constructions).

In the case of integration of the solar thermal collectors in a building envelope additionally to the mechanical requirements further requirements in terms of building physics have to be fulfilled. For example fire resistance of the covering and the fixing system, as well as heat and noise protection of the whole constructional element have to be fulfilled. In the field of moisture proofing rear ventilated or not rear ventilated concepts are in opposition to each other.

Following the classical rules of building physics the resistance against humidity should decrease following the construction layers from inside to

The integration of solar thermal collectors in roof constructions based on commercially available appliances can be considered as state of the art in the market for several years and examples for implementation in renovation processes are wide spread. For large-scale plants in urban building projects there are not always and sufficient suitable oriented roof areas available for the installation of solar thermal collectors. As an alternative the mounting of solar thermal collectors in vertical façades became more and more common. One pioneer of this development was the research project “Façade Integrated Solar Collectors” [22]. Within the framework of the project basic knowledge for the design and technical construction of vertical in façade constructions integrated solar collector fields was developed.

In the research project especially non rear ventilated, directly integrated solar thermal collector plants have been developed. In this context a collector element directly integrated in the façade is understood by the façade-integrated solar thermal collector in which heat insulation is a component of the building as well as a component of the collector. There is no separation in the form of rear ventilation between them. The collector which basically comprises of a fluid-cooled absorber behind a covering glass pane which is fixed by glass bearer profiles combines different kinds of functions.

- **energetic converter**  
Function as a solar thermal flat plate collector
- **heat insulation**  
The attainment of passive gains in the glass covered hollow space causes temporarily smaller heat losses through the exterior wall
- **weatherproofing**  
The glass covering represents an excellent protection against atmospheric conditions
- **design element**  
The visual appearance differs largely from conventional building envelopes

The project team made the following conclusions:

For a wide market penetration of solar thermal systems in retrofitting of buildings it is required that collector systems, which can be integrated in façades, are commercially available. As the development of façade systems for photovoltaic modules has shown, a large market segment can be opened.

In the design process architects and solar planners have to cooperate from the very beginning of a project to arrive at successful conclusions.

For systems with vertical collector plants less irradiation has to be taken into account compared to systems with collectors on an inclined surface (compare Picture 15).

A vertical collector has a better U-value than a tilted collector, because of the reduced heat losses of the collector due to the reduced convection between the absorber and the glazing.

If there is no rear ventilation between the collector and the wall construction, the U-value is lowered because of the minimization of heat losses to the backside of the collector.

The main question for collectors mounted on massive walls is the mounting of the collector without thermal bridges. When mounting collectors on massive walls it is important to take care of thermal bridges, otherwise heat losses of the building in the winter time are significant.

Especially for light weight wall constructions the removal of the humidity is important. If the collector is mounted without an air gap for ventilation the construction must have the possibility to dry to the inside of the building. Therefore the inner layers of the wall must be open for vapour [22].

Picture 30 shows an example for the integration of solar thermal collectors in a suspended light metal façade



picture 30

*Suspended light metal façade with embedded solar thermal collectors, image source: GREENONETEC [8]*

### 5.3.5.2 Colour and shape of solar thermal collectors

The increase of design variety can be seen as a foundation of an intensified application of solar thermal collectors in building envelopes. In this context coloured absorbers are a major demand of architects especially for the design of façade integrated solar thermal collectors.

However coloured absorbers have shown an inferior thermal performance compared to selective coatings of state-of-the-art collectors so far. Within the project “Colourface” [17] selective colour coatings have been developed and ageing tests of the coatings have been performed. The thermal performance of the different coloured absorber coatings was measured by the AEE INTEC in Gleisdorf [1]. The different absorbers were fitted in identical panels and three panels were simultaneously measured by the quasi-dynamic collector test according to EN 12975-2. For the first series aluminium absorbers with the colours blue and gray were used, as well as a comparison with black coated selective coating. The second series was carried out with copper absorbers, which were coated with the colours green and auburn (Picture 31).



picture 31: Test rig, angle of inclination 45° (from left to right: auburn, green, selective coating of absorber), image source: [14]

The efficiency curve obtained from the measurements of the aluminium absorber with the blue coating shows an almost similar performance as those of the absorber with the black selective coating. At low temperature differences, the blue absorption is slightly lower, while coming at the higher temperature differences, the selectivity of the blue coating the thermal efficiency of the blue coating is slightly higher. The conversion factor of the gray absorber is about 16% lower than that of black absorbers. Picture 32 summarizes the results for the measured absorber and glass combinations.

color	glazing	conversion factors	efficiency $\Delta T = 45 \text{ K}$
black selective	low reflecting	81.5	60.2
black selective	structured	79.7	58.4
blue	structured	77.7	46.4
green	low reflecting	75.5	46.6
auburn	low reflecting	71	44.8
auburn	structured	70.6	44.2
grey	structured	61.8	31.3

picture 32: Conversion factors and degrees of efficiency at a temperature difference of 45 Kelvin between ambient temperature and collector mean temperature, data source [14]

The development of selective colour coatings for the absorber is an essential step to bring visually attractive systems on the market. The new building sector as well as renovation projects can be seen as fields of application for coloured solar thermal collectors. The development of absorber coatings which are close to the thermal performance of black selective absorbers will be an objective for the next years. Picture 32 shows a successful example for the integration of blue collector panels in a façade.



Picture 32

South façade of an apartment building with 14 flats in Mooserkreuz / Austria. image source: Austria Solar [2]

Additionally to a bigger variety of colours, increased options for collector shapes would help to increase the acceptance among architects. Rectangular panels in many different aspect ratios are already available. Not rectangular polygonal shapes are still expensive custom-made products in which the not rectangular parts are mainly constructed without absorbers.

### 5.3.5.3 Heat storage

One key component of a solar plant or a solar combisystem respectively is the thermal energy store (TES). The heat store has to fulfil the following tasks:

- Deliver sufficient energy to the heat sink
- Decoupling of mass flows of heat sources and heat sinks
- Store heat from an unsteady heat source (like solar) from times where excess heat is available to times when too little or no heat is available
- Extend the running times for auxiliary heating devices in order to increase their efficiency and decrease emissions
- Allow a reduction in heating capacity of auxiliary heating devices



- Store heat at the appropriate temperature levels without mixing in order to avoid energy losses (stratification)

Today the commonly used type of storage in solar thermal systems is water storage i.e. sensible storage, in which heat is stored by means of a change of temperature of the used storage medium. Several studies have shown that the design of the store in a solar thermal system greatly affects the overall system performance, making it very important to have a good design. Specific testing methods have been developed to judge properties of water stores in solar thermal heating systems like e.g. ENV 12977-3 (CEN, 2001). [9]

During the last twenty years research was focused on the enhancement and optimisation of solar thermal water stores, including investigations about the optimum positions and geometries of in- and outlet connections, the enhancement of the thermal stratification, the minimising of heat losses and the reduction of production costs.



picture 33: Example for the emplacement of a standard water store for solar combisystems located in the old town of Graz, image source: Eduard Wasserfaller

On the one hand water is unbeaten as a heat storage medium in terms of simplicity and cost, on the other hand the required storage volume in order to achieve for example a solar fraction of 100 % is very large. Advanced, compact thermal energy storage technologies are therefore considered to be of key importance on the way to a strongly increased use of solar thermal energy.

Advanced technologies for storage of thermal energy can be divided into latent heat storage, sorption heat storage and thermochemical storage. In this sequence the first technology has the broadest application and less potential for improvement, while the last has the highest potential but is still in an early research stage.

In Austria several research projects were focused on advanced thermal energy storage techniques during the last years. These activities were among others carried out within the framework of IEA SHC Task 32 "Advanced storage concepts for solar and low energy buildings" [16].

#### Latent heat storage with Phase Change Materials (PCM)

The storage capacity of Phase Change Materials is not only based on a temperature change but primarily on the latent heat of a phase change – mostly between solid and liquid – of the storage medium. Different possibilities of the integration of PCMs into a thermal energy store have been studied within the projects [26] and [20].

PCMs encapsulated into modules (macro-encapsulation) can be integrated into a standard water tank, in order to increase the storage capacity. As PCM materials typically have a relatively low thermal conductivity, either the size of the modules has to be chosen in an appropriate way (depending on the necessary charge/discharge power) or the conductivity has to be enhanced by adding a material with a high conductivity (picture 34).

Micro-encapsulated PCMs can be mixed with water, which results in a pumpable suspension, called a PCM-slurry. This fluid can be used as a heat store and a heat transport medium. The microcapsules have a size of only 5-20 micrometers, therefore the low thermal conductivity of the PCM material is no more a problem. However, due to the microcapsules, which are used with mass fractions up to 50 %, the viscosity of the fluid increases and therefore the heat transfer properties decrease and the energy demand for pumping increases compared to water.

A PCM can also be directly integrated into a tank, which is charged and discharged via a suitable heat exchanger. This approach has the advantage of a higher possible PCM volume fraction compared to a solution with macro-encapsulation. On the other hand the used heat exchanger has to fulfil certain requirements in order to ensure an appropriate charging and discharging of the tank. [11]

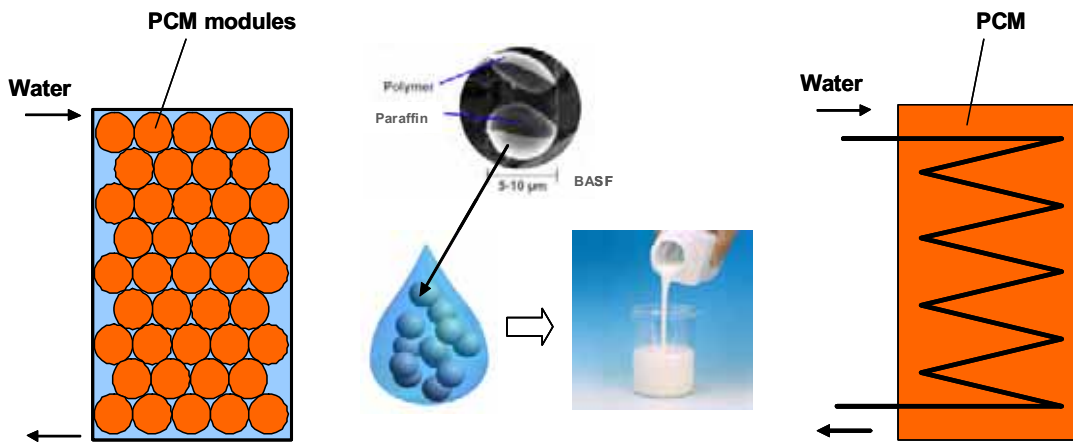

Picture 34

*Different approaches of the integration of PCMs into a storage system (from left to right: macro-encapsulation, micro-encapsulation, bulk PCM tank with immersed heat exchanger), image source [11]*

In [26] and [20] dynamic system simulations of a solar combisystem with different configurations concerning the size of the collector field and the size and kind of the heat store (water and PCM) were carried out. The results showed, that the used PCMs offer an advantage in form of increased solar gains, especially for high solar fractions, but that this advantage is too low in order to justify the increased costs of the material and the store.

The working principle of a sorption heat storage is as follows:

1) **Charging process** (desorption, drying of adsorbent): Heat from a high temperature source (solar thermal collectors) is fed into the device, heats the adsorbent and vapour is desorbed from the adsorbent. The desorbed vapour is condensed at a lower temperature level and then pumped out of the container into a separate reservoir. The heat of condensation has to be withdrawn to the environment.

2) **Storage period**: The dry adsorbent is separated from the liquid working fluid (the connecting valve is closed). As long as these components stay separate, long-term heat storage without losses is possible if the sensible heat involved is neglected.

### Sorption heat storage

A sorption heat store is in fact a thermo-chemical heat pump, which is operated under vacuum conditions. This allows evaporation at a low temperature level and water vapour transport without the need of a pump or fan. The basic principle is described below and shown in Picture 35 (according to [12]).

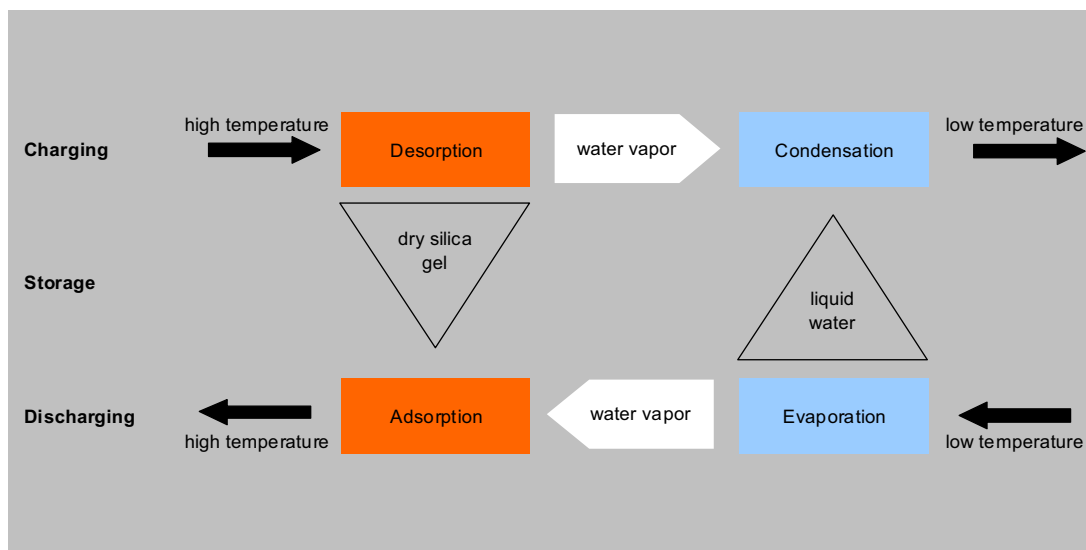

picture 35

*Working principle of a closed-cycle adsorption heat store, image according to [12]*

**3) Discharging process** (adsorption of working fluid on adsorbent): Water is pumped into the evaporator where it evaporates taking up heat at a low temperature level. The vapour is adsorbed and releases the adsorption heat at a higher temperature level. This is the useful heat that can be used for space heating.

#### Development of a prototype

A prototype (picture 36) of a system with the materials combination water/silicagel was developed in the EU Project "MODESTORE - Modular High Energy Density Sorption Storage" [24] by AEE INTEC. This prototype was then tested in a pilot plant installation in the Austrian research project "MODESTORE" [23].

The results showed that the system is working but that the solar fraction, which can be achieved with this type of system, is not higher than achieved with a standard water storage of the same volume. The reason is that the storage capacity of the used sorption material, which can be technically used, is much smaller than the theoretical storage density. This is because the temperature lift which can be generated with this material combination is useable only in a quite narrow bandwidth of charging of the silicagel. Therefore a much higher amount of material would be necessary which is feasible neither technically nor economically. The next step of development would therefore be to develop sorption materials with improved properties, which allow both lower desorption temperatures and a higher temperature lift during discharging.



*picture 36: Prototype storage module developed in [23], image source [12]*

A large part of the research institutes that work on PCM, sorption and thermochemical storage has joined the new IEA Task/Annex 42/24 on "Compact Thermal Energy Storage: material development for system integration".

The goal of this Task is to find and improve compact thermal energy storage materials through a broad and basic research and development initiative. The Task/Annex will bring together experts from the materials development field and the systems integration field. Presently, more than 41 organisations from 17 countries worldwide collaborate in this Task.

#### 5.3.5.4 Pre-fabricated façade elements including solar thermal components

At the moment, most of the renovation projects in Austria reach only the minimum standard of heat protection given in the building code. One main reason for this actual situation is caused by a lack of knowledge and experience with efficient technologies.

Additionally highly efficient construction systems imply an increased level of planning complexity and uncertainties in the building process. The approach to use prefabricated construction elements could relieve many of these problems. Prefabrication allows the assembly of whole façade elements under ideal surrounding conditions in a factory work floor. The use of semi automated machines enables less hours of work and an increased grade of accuracy coupled to a decreased error rate compared to the construction on the building site. This also allows the prefabricated integration of renewable energy systems (solar thermal collectors and photo-voltaic panels) and optimised building equipment (heating, cooling and ventilation).

The façade can be transported by truck to the building site, lifted to the right position and be mounted without use of scaffolding, which saves costs. Such prefabricated systems could help to overcome the present obstacles in highly efficient renovation which were mentioned above.

There are several projects currently working on the development of such construction systems. For example the Austrian Project, "Multifunctional Plug & Play Façade" [25] is aimed at the development of an intelligent, multifunctional façade system for use in modular construction methods with the highest possible level of prefabrication for the new building of large scale residential and office buildings and the renovation of existing houses. Another example can be seen in the IEA project "Prefabricated Systems for Low Energy Renovation of Residential Buildings" which works on prototypes for prefabricated roof systems with integrated HVAC, hot water and solar thermal systems [27].

### 5.3.6 Conclusion and outlook

The minimization of the energy consumption in the building stock and the usage of renewable sources of energy becomes more and more the basic principle of innovative property developers. Not only low initial investments are important due to the apartment owners or tenants, also low operating costs, highest possible supply safety and ecological criteria are increasing in their local value.

If these principles are taken seriously into practice, there will be no way around the increased solar thermal usage. Therefore solar thermal use is already standard in the new buildings of many property developers.

In the field of building renovation miscellaneous technical solutions are already available. This paper shows a bunch of different techniques, examples and layers to implement solar thermal systems in the existing building stock. Nevertheless there is still a large necessity for development in the field of system design and component engineering.

The great potential for solar thermal heating systems appears to be very clear in the Austrian building stock. If, in future, this also shall be used, the politics is called to create corresponding general regulations for an amplified realization in this area.

### 5.3.7 References

- [1] AEE - Institute for Sustainable Technologies, Gleisdorf / Austria  
<http://www.aee-intec.at>
- [2] Austria Solar, special interest group for solar heating and cooling systems,  
<http://www.solarwaerme.at/>
- [3] BIERMAYR, WEISS, GLÜCK, STUKELJ, FECHNER,  
**Erneuerbare Energie in Österreich, Marktentwicklung 2008, Photovoltaik, Solarthermie, Wärmepumpen**, Im Auftrag des Bundesministeriums für Verkehr, Innovation und Technologie, 2009  
more information:  
<http://www.nachhaltigwirtschaften.at/results.html/id5673>
- [4] BMVIT, Federal Ministry for Transport, Innovation and Technology  
<http://www.bmvit.gv.at/en/index.html>
- [5] CEN, ENV 12977-3, **Thermal solar systems and components- Custom built systems – Part 3: Performance characterisation of stores for solar heating systems**. 2001, European Committee for Standardization: Brussels, Belgium
- [6] DRÖSCHER, OHNEWEIN, HALLER, HEIMRATH, **Modular specification of large-scale solar thermal systems for the implementation of an intelligent monitoring system**. Proceedings of ISES Solar World Congress 2009, 11-14 October 2009, Johannesburg, South Africa.
- [7] Gemeinnützige Donau-Ennstaler Siedlungs-Aktiengesellschaft: (GEDESAG)  
<http://www.gedesag.at/>
- [8] GREENONETEC, Solarindustrie GmbH, St. Veit/Glan, Austria,  
<http://www.greenonetec.com>
- [9] HADORN J.C., LEHMANN B., WEBER R., LETZ T., STREICHER W., BALES C., HALLER M., VOGELSANGER P., SCHULTZ J.M., CITHERLET ST., YAMAHA M., CABEZA L., HEINZ A., GANTENBEIN P., HAUER A., JAEHNIG D., KERSKES H., HENNING H.M., NUÑEZ T., VISSCHER K., LAEVEMANN E., PELTZER M., VAN BERKEL J. (2005): **Thermal Energy Storage for Solar and Low Energy Buildings**, State of the Art by the IEA Solar Heating and Cooling Task 32, ISBN 84-8409-877-X
- [10] HALMDIENST Christian, developer of simplex, more information:  
<http://www.pink.co.at/>
- [11] HEINZ A. (2007): **Application of Thermal Energy Storage with Phase Change Materials in Heating Systems**, Dissertation at the Faculty of Mechanical Engineering, Graz University of Technology
- [12] JAEHNIG D., HAUSNER R., WAGNER W., ISAKSSON C. (2006): **Thermo-Chemical Storage for Solar Space Heating in a Single-Family House**, Ecostock Conference, 31th May – 2nd June 2006, Stockton College, Pomona, USA
- [13] **Meteonorm 5.1**, Global meteorological database for solar energy and applied climatology; Fabrikstrasse 14, CH - 3012 Bern, Switzerland, Ausgabe 2004



- [14] MÜLLER, WAGNER, HAUSNER, KÖHL, HERKEL, HÖFLER, Colourface – Farbige Fassenkollektoren  
more information:  
[http://www.aee-in-tec.at/index.php?seitenName=projekte\\_Detail&projektId=43](http://www.aee-in-tec.at/index.php?seitenName=projekte_Detail&projektId=43)
- [15] ÖNORM B 81 10-5, Wärmeschutz im Hochbau, Teil 5: Klimamodell und Nutzungsprofile, Ausgabe 2007-08-01
- [16] PROJECT: **Advanced Storage Concepts for Solar and Low Energy Buildings**, IEA SHC Task 32, International Energy Agency research programme Solar Heating and Cooling Programme  
more information:  
<http://www.hausderzukunft.at/results.html/id2817>
- [17] PROJECT: **Colourface - Planungsrichtlinien für farbige Fassadenkollektoren**  
Herausgeber: AEE INTEC, 2004
- [18] PROJECT: **Demonstration objects accompanied by measurement techniques for optimised and standardised solar systems in the construction of residential buildings for several families (OPTISOL)**, Austrian Program on Technologies for Sustainable Development, Subprogram "Building of Tomorrow", funded by "Federal Ministry for Transport, Innovation and Technology" (BMVIT), German, only Abstract in English  
Project lead: AEE INTEC  
more information:  
<http://www.hausderzukunft.at/results.html/id1823>
- [19] PROJECT: **Heat supply of development areas through supplementary solar supported near heat nets (MOSOL-NET)**; Austrian Program on Technologies for Sustainable Development, Subprogram Energy Systems of Tomorrow " (Energiesysteme der Zukunft), funded by "Federal Ministry for Transport, Innovation and Technology" (BMVIT),  
Project leader: AEE INTEC and Institute of Thermal Engineering, TU Graz  
more information:  
<http://www.energiesystemederzukunft.at/results.html/id5111>
- [20] PROJECT: **IEA SHC 42, Task Solar Thermal Plants with Advance Thermal Storage Technologies for Low Energy Buildings**, Fortschrittliche Wärmespeicher zur Erhöhung von solarem Deckungsgrad und Kesselnutzungsgrad sowie Emissionsverringering durch verringertes Takten; Austrian Program on Technologies for Sustainable Development, Subprogram "Energy Systems of Tomorrow"(Energiesysteme der Zukunft), funded by "Federal Ministry for Transport, Innovation and Technology" (BMVIT), Project leader: Institute of Thermal Engineering, TU Graz  
more information:  
<http://www.hausderzukunft.at/results.html/id2817>
- [21] PROJECT: **IP-Solar**; supported by the Austrian Climate and Energy Fund and carried out as part of the "Energy of the Future" programme.,  
Project lead: S.O.L.I.D. GmbH  
more information:  
<http://www.ip-solar.com/>
- [22] PROJECT: **Façade Integrated Solar Collectors**; Austrian Program on Technologies for Sustainable Development, Subprogram "Building of Tomorrow" (Haus der Zukunft), funded by "Federal Ministry for Transport, Innovation and Technology" (BMVIT),  
Project lead: AEE INTEC  
more information:  
<http://www.hausderzukunft.at/results.html/id1783>
- [23] PROJECT: **MODESTORE – Modular High Energy Density Sorption Heat Storage**, Austrian Program on Technologies for Sustainable Development, Subprogram "Building of Tomorrow" (Haus der Zukunft), funded by "Federal Ministry for Transport, Innovation and Technology" (BMVIT), Project leader: AEE INTEC, Gleisdorf  
more information:  
<http://www.nachhaltigwirtschaften.at/results.html/id3956>
- [24] PROJECT: **MODESTORE - Modular High Energy Density Sorption Storage**, European Project, 2003 – 2006, project number NNE5-2001-00979, Project leader: Fraunhofer ISE, Germany

- [25] PROJECT: **Multifunctional Plug&Play Façade (MPPF)**, development of multifunctional façade systems for use in modular construction methods including a high level of pre-fabrication, Competence Centers for Excellent Technologies, Project lead: FIBAG and Institute of Thermal Engineering, TU Graz  
more information:  
<http://www.mppf.at/>
- [26] PROJECT: **PAMELA: Phase Change Material Slurries and their Commercial Applications**; European project, 2001-2004, project number ENK6-CT-2001-00507, Project leader: University of Ulster, UK
- [27] PROJECT: **Prefabricated Systems for Low Energy Renovation of Residential Buildings**, IEA ECPCS Annex 50, International Energy Agency research programme Energy Conversion in Buildings and Community Systems  
more information:  
<http://www.ecbcs.org/annexes/annex50.htm>
- [28] PROJECT: **Regional concepts of CO<sub>2</sub>-neutral heat demand and refrigeration load covering**, Austrian Program on Technologies for Sustainable Development, Subprogram "Energy Systems of Tomorrow" (Energiesysteme der Zukunft), funded by "Federal Ministry for Transport, Innovation and Technology" (BMVIT), Project leader: Research Studios - Studio iSPACE  
more information at  
<http://www.energiesystemederzukunft.at/results.html/id5378>
- [29] PROJECT: **Solar Assisted Heating Networks**, Austrian Program on Technologies for Sustainable Development, Subprogram "Building of Tomorrow" (Haus der Zukunft), funded by "Federal Ministry for Transport, Innovation and Technology" (BMVIT), 2002, German, only Abstract in English, Project lead: Institute of Thermal Engineering (TU Graz) and AEE INTEC  
more information:  
<http://www.nachhaltigwirtschaften.at/results.html/id1782>
- [30] PROJECT: **wohnsolarl, solar thermal systems for multiple-family houses**, Austrian Program on Technologies for Sustainable Development, Subprogram "Building of Tomorrow" (Haus der Zukunft), funded by "Federal Ministry for Transport, Innovation and Technology" (BMVIT), Project lead: AEE INTEC  
more information:  
<http://www.hausderzukunft.at/results.html/id4620>
- [31] S.O.L.I.D. Gesellschaft für Solarinstallation und Design mbH, Puchstraße 85, A-8020 Graz, [www.solid.at](http://www.solid.at)
- [32] solar yield 2005 bis 2007, gswb: <http://www.gswb.net/>
- [33] TRNSYS, Transient System Simulation Program, Solar Energy Laboratory, University of Wisconsin-Madison, WI 53706 USA
- [34] VDI 2067, VDI 2067- Richtlinie, Berechnung der Kosten von Wärmeverorgungsanlagen, Raumheizung, Blatt 2, herausgegeben vom Verein Deutscher Ingenieure, VDI-Verlag, Düsseldorf 1993
- [35] WEISS, BERGMANN, STELZER, **Solar Heat Worldwide, Markets and Contribution to the Energy Supply 2007**, IEA Solar Heating & Cooling Programme, Edition 2009  
more information:  
<http://www.nachhaltigwirtschaften.at/results.html/id4012>
- [36] World Radiation Data Centre, <http://wrdc-mgo.nrel.gov/>

## Authors

Thomas Mach  
Institute of Thermal Engineering  
Graz University of Technology  
[thomas.mach@tugraz.at](mailto:thomas.mach@tugraz.at)



Richard Heimrath  
Institute of Thermal Engineering  
Graz University of Technology  
[heimrath@tugraz.at](mailto:heimrath@tugraz.at)



Andreas Heinz  
Institute of Thermal Engineering  
Graz University of Technology  
[andreas.heinz@tugraz.at](mailto:andreas.heinz@tugraz.at)



Angela Dröscher  
Institute of Thermal Engineering  
Graz University of Technology  
[angela.droescher@tugraz.at](mailto:angela.droescher@tugraz.at)



Thomas Müller  
AEE - Institute for Sustainable Technologies  
<http://www.aee-intec.at>



Christian Fink  
AEE - Institute for Sustainable Technologies  
[c.fink@aee.at](mailto:c.fink@aee.at)



This chapter is carried out in the framework of the Austrian participation in the Energy Technology Programme of the IEA and funded by the Austrian Ministry for Transport, Innovation and Technology.

### 1.3 *Aufgespritzte Innendämmung aus Zellulose ohne Dampfbremse*

#### Originaltitel:

Sprayed-on and trowel-applied internal cellulose insulation without vapour barrier

Herwig Hengsberger  
Peter Kautsch  
Rudolf Plagge  
Andreas Heinz  
Hans Petzold  
Wolfgang Lackner  
Robert Schmied  
Peter Häupl  
Wolfgang Streicher  
Friedrich Skofitsch

What is more, because of its excellent moisture-retaining properties combined with the high capillary conductivity of the bound cellulose flakes, in certain circumstances it is possible to do without a vapour barrier, which often tends to be fault-prone. This can increase the acceptance of internal insulation measures quite considerably in building practice. In addition, there has recently been a growing demand for insulation materials for historic buildings that preserve the original character of the surface. The sprayed-on cellulose insulation system covered with thick plaster responds very well to this trend.

#### 5.4.2 Methodology

Following extensive laboratory experiments for developing and optimising the sprayed-on cellulose layer and the special internal plaster, the insulation system was assessed by means of in situ measurement of hygrothermal conditions across the full cross-section of the structural element in real climate conditions over a duration of two condensation and two evaporation periods. The extensive data collected regarding the characteristic material values of the internal plaster and the bound cellulose insulation and integration of these data to draw up complex moisture-retention and transport functions served as a basis for the accompanying hygrothermal simulation calculations using the DELPHIN software package [38] and to validate the mathematical model with regard to the innovative building materials. This created a basis for a preliminary calculative estimation of future renewal measures.

#### 5.4.3 Procedure

The innovative insulation system consists of defibrated recovered paper with an admixed flame-retardant and fungicide component of borates and ammonium phosphate. By means of a newly developed conveyor machine, that does not transport the loose cellulose flakes in portions by means of a rotary feeder, as was previously the case, but rather continuously by means of a centrifugal fan, thus homogenising the flow of flakes, the material is delivered to a spray head, where it is moistened and, mixed with an acrylic-based polymer, sprayed onto almost any surface [picture 1]. Then the cellulose layer is flattened with a rotating roller and covered with specially formulated internal plaster. This plaster should be a largely open-diffusion, moisture-retaining light-weight mineral plaster with a water vapour diffusion resistance  $\mu$ -factor  $< 20$  and a dry bulk density  $< 1200 \text{ kg/m}^3$ ; it should be suitable for machining

#### 5.4.1 Introduction

Thermal renovation of buildings with a low thermal standard is the most efficient way to reduce CO<sub>2</sub> emissions in relation to investment costs. In the past, thermal renovation of existing inner-city, in some cases listed, buildings by means of external insulation involved a great deal of time and work, if it was possible at all in view of complicated ownership situations, structured façade geometries, or because established building lines had already been reached. Although it hardly seems realistic to try to achieve Scandinavian insulation standards, for example, in old buildings, internal insulation can help reduce the U-value of existing outside walls by as much as 50%.

Because the ecological quality of the building materials used will need to be given greater attention in future, the aim of a research project under the "Haus der Zukunft" (Building of Tomorrow[37] subsidised by the Austrian Federal Ministry of Transport, Innovation and Technology was to examine sprayed-on and trowel-applied layers of cellulose insulation made from recovered paper with regard to their suitability as internal insulation without a vapour barrier both in terms of mechanical performance and building physics [49].

Cellulose insulation materials can make a valuable contribution to ecologising the insulation material market because, being a recycling product, they are manufactured on the basis of the renewable resource wood. As a practically CO<sub>2</sub>-neutral insulation material with an extremely low primary energy demand, cellulose insulation can also be attributed a particularly positive environmental relevance.

and should be applied to the cellulose insulation in one coat of 10 to 15 mm.

The combination of old masonry and new internal plaster [picture 2] ensures that the system is air-tight in the plane. Although hair-line cracks in the internal plaster lead to slightly higher diffusion flows at the affected spots, these are buffered very well by the high capillary conductivity of the surrounding cellulose insulation.

As with every internal insulation system, an air-tight seal to the window, inside walls or wooden beam ceilings is of particular importance. A current research project focuses specifically on incorporating wooden beam ceilings into a variety of open-diffusion internal insulation systems [50].

As a basis for the building physics simulation calculations, following numerous steps to optimise the final plaster formulation, moisture sorption in the hygroscopic range based on ISO DIS 12571 [46] and in the superhygroscopic range based on ISO DIS 11274 [45] (sorption isotherm and water retention) and drying characteristics were determined in addition to standard parameters such as water demand, air pore content, water retention capacity, fresh mortar bulk density, solidification behaviour, strength development, flexural and compressive strength, total and open porosity, modulus of elasticity, water absorption coefficient (based on EN ISO 15148 [43]), hydraulic conductivity (based on ISO/CD 17312 [47] and 17313 [48]), water vapour diffusion resistance factor  $\mu$  (dry-cup, based on EN ISO 12572 [42]), thermal conductivity, heat capacity and dry bulk density.

The characteristic material values measured at Dresden University of Technology were prepared for direct use in the simulation models, that require continuously differentiable and integrable functions instead of numerical data.

The characteristic values were functionalised with the aid of a physical material model, mapping water retention characteristics, liquid water conductivity, water vapour diffusion resistance, and thermal conductivity as functions.

In order to validate the material measurements in the laboratory and the calculative functional adaptations, typical suction and evaporation experiments were recomputed with a physically based, scientific simulation program so as to adjust the function set and verify the material. The characteristic material values and hygrothermal functions were entered into a relational database system in which the material functions are visualised graphically in a clear, concise form and compared for easy selection.

#### 5.4.4 In situ measurement

In order to measure and record the hygrothermal processes throughout the section of the wall, the system was covered with an on average 5 cm thick layer of cellulose on the west- and south-facing outside wall, consisting of 50 cm thick full-brick masonry plastered on both sides, of a roughly two-hundred-year-old building in Graz. Both the insulated and an uninsulated control wall section were equipped with numerous sensors.

In addition to global radiation and heat flow in



picture 1

*Spraying*



picture 2

*Cross-section of the insulation system*

the insulated and uninsulated area, this involved measuring the temperature and moisture content of the outside and inside room air and typical cross-sections in the middle of the wall, in the inside edge of the outside corner, and in the area where the inside wall abuts the inside-insulated outside wall for a duration of two condensation and two drying periods [picture 3].

In order to determine the moisture content of the structural element, the relative humidity of the air enclosed in the structural element and in

the area of the specially developed, just 3 mm thin, salt-resistant sensors, i.e. equilibrium moisture content, was measured at hourly intervals. On the basis of the sorption isotherms of the building material it is thus possible to calculate the absolute moisture content (water content) in the material and local dew point temperature.

### Results

The measured data were continuously evaluated and incorporated into the simulation calculations. One particularly gratifying fact was that spraying did not impair the combined temperature/moisture sensors as they had been specially adapted for this purpose. Apart from the first condensation period, that coincided with the drying phase of the insulation system, all sensors returned plausible values, and it was observed that condensation dried up completely during the evaporation periods, there was no dreaded accumulation of moisture content over a period of several years.

### 5.4.5 Strength measurements

The aim of these analyses was not only to determine tensile strength perpendicular to the sample plane of the cellulose material itself, but also the adhesion bond with the base. For this purpose, the insulation material was sprayed onto 10 cm thick honeycomb bricks with which an unmortared sample wall had been built.

Once the cellulose layer had dried, it was separated along the brick joints and the layer of cellulose on the separate bricks was cut to a thickness of 4.5 cm parallel to the surface of the brick.

The measurements revealed strength values that exceed the requirements for mineral wool façade insulation boards to ÖNORM B 6135 [51] and the requirements for factory-made cellulose insulation boards to the ÖTZ specifications in accordance with OIB Directive [52] of  $\geq 12.0$  kPa in both cases.

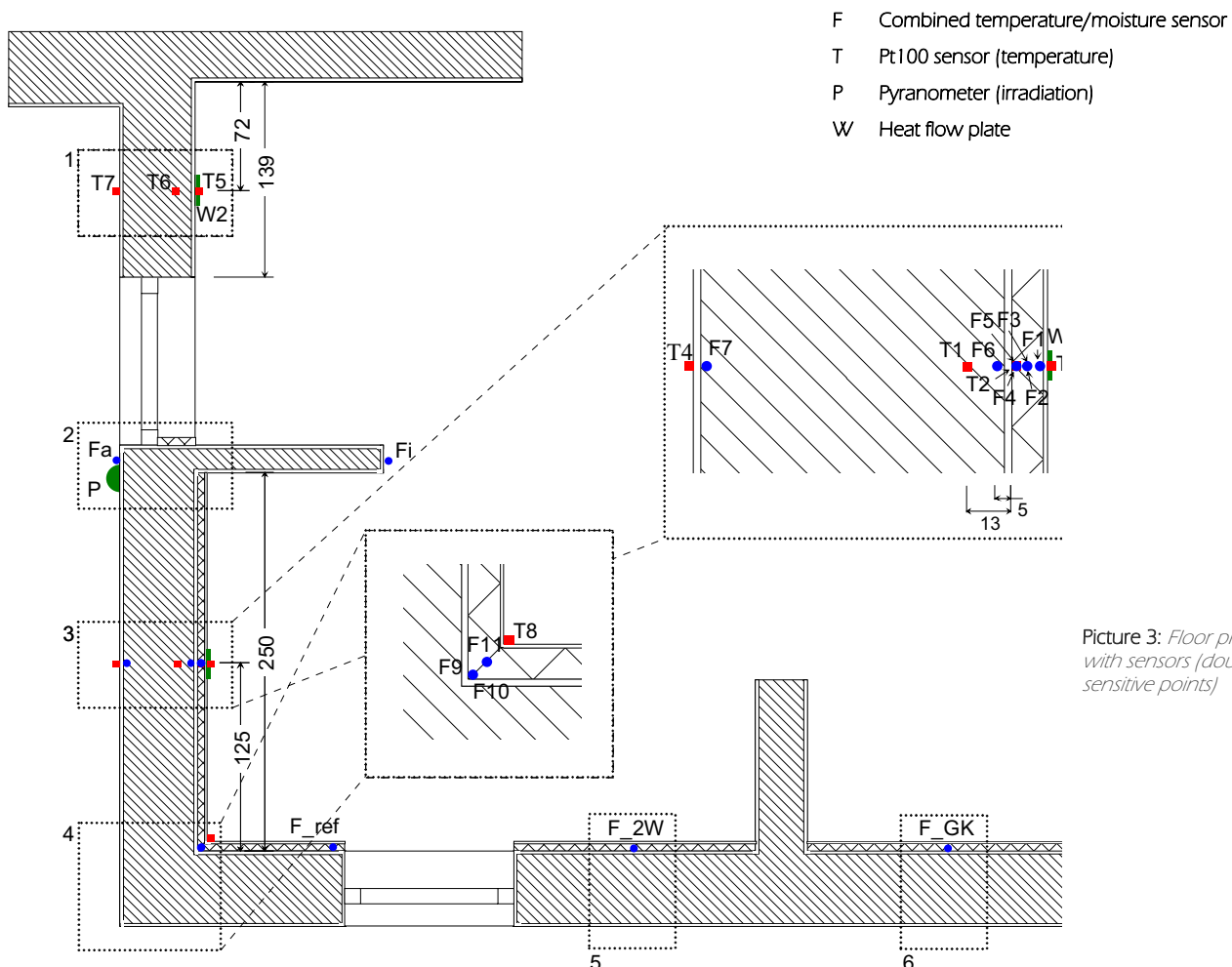

Picture 3: Floor plan of the trial room with sensors (double sensors at sensitive points)



The pull-off tests performed on the cellulose/plaster system sprayed in the trial house all revealed material fractures in the insulation layer, thus confirming the excellent adhesion bond of the innovative internal plaster with the cellulose base.

#### 5.4.6 Hygrothermal simulation calculations

The Institute of Building Climatology at Dresden University of Technology developed an integrated physical model for coupled energy and material transfer in capillary-porous building materials. On the one hand, this model is implemented in the form of the numerical simulation package DELPHIN [38] and, on the other, finds expression in measuring regulations and measuring procedures above all for moisture-related material properties [44].

Unlike the “Glaser method”, that allows measurement under simplified stationary conditions by calculating the maximum quantity of condensation in relation to the amount of drying during the warm season, but which fails to account for moisture retention and moisture conductivity of building materials, the DELPHIN simulation tool can be used to simulate heat and moisture retention as well as moisture transport under non-stationary conditions.

All humidity retention and conversion processes are included; boundary conditions may be model-based constant boundary conditions or any non-stationary climate boundary conditions. As such, it is possible to expose a structure to a range of outdoor climate conditions (including rain, short- and long-wave radiation exchange) or to examine the influence of different user-dependent indoor climates, including those measured in situ.

In order to model real processes, moisture conductivity and the moisture retention function are important building blocks; the latter describes retention of moisture in capillary-porous materials as dependent on relative humidity (in the pores) and capillary pressure, and the analysis of super-hygroscopic properties is of particular relevance in assessing the quantity of condensation that builds up and in estimating the time that condensation takes to dry [53].

The moisture retention function is determined by means of pressure plate and sorption measurements. An additional determination of moisture retention can also be performed – with the aid of a suitable pore model – by means of a pore structure analysis (mercury intrusion porosimetry, nitrogen BET and optical methods).

Finally, capillary hydraulic conductivity is derived from the pore structure and the measurement of the water sorption coefficient ( $A_w$  value) and water resistance in the free saturation range.

As a result of the low thermal conductivity of 0.052 W/mK, despite the considerable density of 92 kg/m<sup>3</sup>, the bound cellulose is very well-suited as an insulation material.

As expected, vapour diffusion resistance  $\mu$  (dry-cup) is relatively low, approximately 2.5 [-]. The measurements also revealed a surprisingly high liquid water conductivity. This means that condensation that builds up as a result of internal insulation can be removed by capillary action.

The porous internal plaster formulated specially for the sprayed-on cellulose has a relatively low water vapour diffusion resistance factor ( $\mu$ ) of approximately 6 [-]. The cellulose/plaster system is thus a capillary-active and open-diffusion internal insulation system.

Once the measurements of outdoor and indoor climate for the trial house and measurements on and inside the structure had been obtained, the simulation calculations were continuously compared with the measured values. The measured climate values were used as non-stationary boundary conditions for the simulation, from which the state values in the structure were derived. The parameters defined in the laboratory were used for the materials.

The comparison of temperatures in the middle of the insulation shows a very good agreement. Humidities in the measurement are slightly higher than the calculated values and show higher amplitudes, although the deviations of around 5 % relative humidity are within an acceptable range. The cause of this effect is assumed to be that humidity measurements are performed in a small air space, while the simulation represents the conditions in the material itself.

Because of the generally good agreement between the measurements and calculations, it was possible to use other variables from the simulation calculations that cannot be measured directly, such as moisture mass in the structure and moisture profile, in order to assess the behaviour of the structure. In the real indoor and outdoor climate conditions in the trial house, the moisture profiles displayed a max. moisture content of just over 5 vol.% in one- and two-dimensional calculations.

Both in the wall and edge area, humidities of more than 80% occur over a prolonged period during the cold period. Temperatures are relatively low, however, with the effect that these



humidity values do not entail such a high risk of mould as when the 80% limit is reached on room-facing surfaces exposed to spores.

Light-microscopy analysis of samples from the trial house did not reveal any mould growth. Although the DIN 4108-equivalent analysis [39] with a constant climate indicates condensation, at approximately  $0.6 \text{ kg/m}^2$  it is still within the permissible range and can dry up completely.

The system of plaster and sprayed-on cellulose insulation can thus already be classified as positive in the undisturbed area of the wall from a hygrothermal point of view as the high capillary conductivity of the cellulose removes condensation by capillary action. Structural element joints such as wooden beam ceilings or window frames must be examined separately. Also, the findings can be transferred to other structures and other climates with the aid of the measured material functions and the hygrothermal simulation calculations.

#### 5.4.7 Summary and prospects

By means of almost two years of in situ measurements it was possible to confirm the assumed excellent moisture transport and retention capacity of bound cellulose insulation. It was shown that the moisture that builds up during the condensation phase dries up completely during the evaporation phase – i.e. that the content of water in the insulation layer does not accumulate over a period of years. The innovative internal plaster formulated specially for the special plaster base has an extremely low water vapour resistance factor – an important pre-condition to assist the cellulose insulation drying process during the evaporation period. By combining these two new developments it was possible to create the prototype of an internal insulation system that in certain circumstances does away with the need for a vapour barrier thanks to special material properties.

One extremely important result is the excellent agreement between the hygrothermal simulation calculations and the in situ measurements. Hence, with the aid of appropriate material parameters in future it will be possible to calculate and estimate the effects of these innovative internal insulation measures. The sprayed-on cellulose insulation meets the important tensile strength requirements perpendicular to the sample plane that must be fulfilled by external insulation and finishing systems, for example mineral wool insulation boards.

The innovative internal insulation system presented here has already been practically tested

on a number of pilot buildings, for instance an apartment building in Fürth near Nuremberg [picture 4] or a 400-year-old listed farmhouse [picture 5] and [picture 6].



picture 4: Apartment house in Fürth near Nuremberg thermally renovated with the new insulation system



picture 5: Thermally renovated listed farmhouse with stone masonry in Kirchbichl / Tyrol



picture 6: Interior before and after renovation (Kirchbichl /Tyrol)

Although the homogeneity of flake transport was considerably improved by developing a completely new kind of conveyor machine, there is still a need for further research regarding the influence of different lengths and heights of conveyor tubing and with regard to differences in the spraying process.

A recently launched project subsidised by the Austrian Climate and Energy Fund examines the joints to wooden beam ceilings in comparison with other open-diffusion internal insulation systems available on the market and sets out to develop an innovative monitoring system for almost completely non-destructive analysis of any microbial growth.

## References

- [37] **Building of Tomorrow** (Haus der Zukunft), Program on Technologies for Sustainable Development, funded by "Federal Ministry for Transport, Innovation and Technology" (BMVIT) more more information: [www.hausderzukunft.at](http://www.hausderzukunft.at)
- [38] **DELPHIN**, current version 5.6, simulation program for coupled heat, moisture and material transfer in capillary-porous building materials. Details at: <http://www.bauklimatik-dresden.de/downloads.php> (19.01.2010)
- [39] **DIN 4108-3**, Thermal protection and energy economy in buildings - Part 3: Protection against moisture subject to climate conditions - Requirements and directions for design and construction, 07/2001
- [40] **DIN EN 15101-1** Thermal insulation products for buildings - In-situ formed loose-fill cellulose products - Part 1: Specification for the products before installation; German version prEN 15101-01/2007
- [41] **DIN EN 15101-2** Thermal insulation products for buildings - In-situ formed loose-fill cellulose products - Part 2: Specification for the installed products; German version prEN 15101-02/2007
- [42] **EN ISO 12572**, Hygrothermal performance of building materials and products - Determination of water vapour transmission properties, 09/2001
- [43] **EN ISO 15148**, EN ISO 15148, Hygrothermal performance of building materials and products - Determination of water absorption coefficient by partial immersion, 03/2002
- [44] **GRUNEWALD, BOMBERG, An engineering approximation of material characteristics for input to Heat, Air and Moisture simulations**. In: Tagungsband zum 11. Bauklimatischen Symposium Dresden 2002. Eigenverlag TU Dresden 2002
- [45] **ISO 11274**, Soil quality - Determination of the water-retention characteristic - Laboratory methods, 01/2001
- [46] **ISO 12571**, Hygrothermal performance of building materials and products - Determination of hygroscopic sorption properties, 04/2000
- [47] **ISO 17312**, Soil quality - Determination of hydraulic conductivity of saturated porous materials using a rigid-wall permeameter, 03/2005
- [48] **ISO 17313**, Soil quality - Determination of hydraulic conductivity of saturated porous materials using a flexible wall permeameter, 07/2004

- [49] KAUTSCH et al., **Sprayed-on and Plaster-covered Cellulose-insulation without vapour barrier**, Austrian Program on Technologies for Sustainable Development, Subprogram "Building of Tomorrow" (Haus der Zukunft), Project leader: TU Graz  
more information:  
<http://www.hausderzukunft.at/results.html/id2756>
- [50] **OEKO-ID** – Interior insulations for thermal retrofitting of buildings – options and constraints of ecological, open - diffusion insulation systems (2009-2011)
- [51] **ÖNORM B 6135** External thermal insulation composite systems of mineral wool MW-PT and final coat, 10/1998
- [52] **ÖTZ** - Österreichische Technische Zulassung – Anforderungsprofil für Zellulosefaserplatten entsprechend der OIB-Richtlinie „Brennbare Dämmstoffe für den Wärme- und/oder Schallschutz“, 02/2000
- [53] PLAGGE, CERNY, MATIASOVSKY, **Laboratory measurements**. In: Development of insulation materials with specially designed properties for building renovation, EU-Projekt, TU Dresden 2003
- [54] SCHUSTER, SZEIDER, WÖLFL: **Wärmeschutzmaßnahmen an Wohngebäuden**, Zentrum für Bauen und Umwelt, Donau-Universität Krems, 1999

#### Authors

Herwig Hengsberger  
Institute of Building Construction  
and Building Physics  
Graz University of Technology  
hengsberger@tugraz.at



Peter Kautsch  
Institute of Building Construction  
and Building Physics  
Graz University of Technology  
kautsch@tugraz.at



Rudolf Plagge  
Institute of Building Climatology,  
Dresden Technical University,  
rudolf.plagge@tu-dresden.de



Andreas Heinz  
Institute of Thermal Engineering  
Graz University of Technology  
andreas.heinz@tugraz.at

Hans Petzold  
Institute of Building Climatology,  
Dresden Technical University,  
hans.petzold@tu-dresden.de

Wolfgang Lackner, Zellulosedämmstoffproduktion  
CPH-Beteiligungs GmbH & Co KG,  
w.lackner@cph.at

Robert Schmied  
Wietersdorfer und Peggauer Zementwerke AG,  
r.schmied@wup.baumit.com

Wolfgang Streicher  
Institute of Thermal Engineering,  
Graz University of Technology,  
w.streicher@tugraz.at

Peter Häupl  
Institute of Building Climatology,  
Dresden Technical University

Friedrich Skofitsch  
Institute of Technology and Testing  
of Building Materials  
Graz University of Technology,  
doris.marchler@tugraz.at

This chapter is carried out in the framework of the Austrian participation in the Energy Technology Programme of the IEA and funded by the Austrian Ministry for Transport, Innovation and Technology.

#### 1.4 Lüftungsanlagen in Sanierungsvorhaben

Originaltitel:

Ventilation systems in renovation

Olivier Pol

Wolfgang Leitzinger

#### 5.5.2 Status of ventilation systems in standardization activities

The following standards apply to ventilation systems in residential buildings:

Austria:

ÖNORM H 6038 – controlled (balanced) mechanical supply and exhaust ventilation for dwellings including heat recovery. The H 6038 is not very restrictive. It defines the main components of a controlled ventilation system and minimum design requirements but it does not require the compliance of quality criteria.

Germany:

VDI 6022: hygienic requirements for ventilating and air-conditioning systems and air-handling units

European Standards:

EN 15665:2009 - Ventilation for buildings - Determining of performance criteria for the design of residential ventilation systems

CEN/TR 14788:2006 - Ventilation for buildings - Design and dimensioning of residential ventilation systems. Stand alone and hybrid systems (combination of mechanical and free ventilation) are handled in this technical guideline.

EN 13465:2004 - Ventilation for buildings - Calculation methods for the determination of air flow rates in dwellings. This standard provides a calculation method to determine the minimal fresh air supply rate for the different parts of a dwelling (sleeping rooms, kitchen, living room).

EN 13779:2007 - Ventilation for non-residential buildings - Performance requirements for ventilation and room-conditioning systems. Even if this standard is dedicated to non-residential buildings, some reference values and guidelines are also useful for residential buildings

EN 13141 (parts 1 - 10) - Ventilation for buildings - performance testing of components for residential ventilation. Some parts of this standard are in revision, such as part 7 (mechanical supply and exhaust ventilation units including heat recovery). Part 7 has been revised concerning more detailed testing conditions for ventilation units considering combined systems including heat pumps using waste heat from exhaust air. The EN 13141 should be more accepted from the CEN members after revision.

EN 13142:2004 - Ventilation for buildings - Components/products for residential ventilation - Required and optional performance characteristics

#### 5.5.1 Introduction

Increasing the air tightness of building envelope is one of the main conditions for obtaining a high energy performance in the buildings being renovated, mainly because it allows for reducing the heat energy losses through infiltrations. This measure needs to be associated with the installation of a mechanical ventilation system mainly because:

- the fresh air supply which was guaranteed by uncontrolled infiltration rate before renovation works can not be ensured in that way anymore if air tightness of envelope is increased. This can lead to a bad air quality corresponding to a high CO<sub>2</sub>-concentration in internal air (>600ppm). More details on this issue are presented in the Subtask D booklet.

- a high air tightness corresponds also to a vapour barrier hindering humidity transfer through the building envelope. In winter, high relative air humidity rates can be observed in case of insufficient infiltration or natural ventilation rate. If thermal bridges have not been accurately handled during renovation works and the humid internal air gets in contact with the cold side of the building envelope, there is a risk of condensation which can lead to constructive damages if during rest of the year, the water condensed can not evaporate entirely.

The reasons mentioned here are sufficient to support the fact that mechanical ventilation systems are indispensable when dealing with advanced housing renovation: manual window opening usually don't guarantee a sufficient air change rate as the frequency of window opening only depends on user behaviour. Natural ventilation concepts might be interesting low energy solutions, but in housing renovation projects the possibilities are more limited than in new buildings.

#### 5.5.2 Normative Aspects

Before providing further recommendations on ventilation system design, it is necessary to summarise the contents of international and national standards available for ventilation systems in the housing sector. In particular it is important to know which type of requirements is provided in which standard.

### 5.5.3 Background

A field study on technical status of ventilation systems in residential buildings was realised in 2002-2003 in Austria. It focused on balanced ventilation systems including heat recovery in single family houses. The project was carried out by four Austrian institutes (FH Kufstein, Energie Tirol, AEE INTEC and arsenal research) and the results are documented in a report in German language [55]. The main project outcomes being also valid for residential buildings undergoing renovation activities are summarised here. Within the project, 92 ventilation systems were investigated. The goals of the project were:

- Survey of existing solutions and assessment of commonly used design criteria for balanced ventilation systems
- Survey of the acceptance of balanced ventilation systems

The assessment methods used were:

- 1) documentation of systems installed few years before the survey was done. The documentation contained characteristic figures of the system (e.g. design data, ventilation rate, kind of supply system, kind of defrosting strategy, filter quality, etc.), photos of specific solutions and parts of the system and measurement results (pressure drop, air temperatures, air change rates for each room, etc.).
- 2) assessment of user satisfaction with the system taking into account the results of the technical assessment. Users were asked and a questionnaire was filled out.

The main results were:

Although the satisfaction with the reached effect of mechanical ventilation was very high (about 87% of the asked users were satisfied with their ventilation systems), the systems had many defects leading to low efficiency and insufficient air quality and comfort. Some of the effects were not identified by the users, for example a higher energy consumption caused by blocked filters or missing duct thermal insulation.

One main and often mentioned problem was the disturbing sound level in the sleeping rooms. This problem can be caused by too small diameters of pipes and components, missing sound absorbers or too loud ventilation units. As a consequence the users often lower the ventilation rate or switch the ventilation system off at night.

The choice of air change rates for the rooms was not done correctly in many cases (under sizing problem). Only few documents presenting calculation results could be found. Pictures and installation plans were also very rare. This could not facilitate the work of service personnel if a problem would occur.

Many failures are related to the missing experience of installers in this technology field. On the other hand many problems are linked to the missing availability of data like consistent energy performance figures, acoustic or hygienic properties of components.

As a result of the project a draft of about 55 technical quality criteria was developed. This paper has been updated regularly considering new standards, new experiences and expert contributions from German speaking countries. The paper is available in German only on [56].

Additionally to the results of the survey based on single family houses, an ongoing project is concentrating on centralised ventilation systems in apartment buildings (presented [56]). The target of this project is to develop a general design guideline for balanced ventilation systems in residential buildings using decentral, semi-central und central systems. The final report is to be completed in May 2010.

### 5.5.4 General requirements for a high user acceptance

It is difficult to define standardised technical quality criteria based on a wider international level because building stocks and requirements are quite different from one country to the other. However it is possible to define general criteria that may achieve a high acceptance level of the occupants.

On the basis of the experience and field studies in Austria and Switzerland, the most important criteria generally applicable for new buildings as well as for renovation are:

- the air change rate has to comply with the hygienic requirements;

Many problems occur when air change rate is not adapted to the variable needs of the users. Especially in cold climates with temperatures under 0°C over several weeks the indoor air humidity may drop below 30% if the air change rate is too high. On the other side, when the air change rate is too low, users mostly only notice it when they enter the room, not when they have been in the room for many hours.



In many cases they may open windows when they do not have the possibility to increase the ventilation rate. Otherwise users may not accept the system.

- the system is designed to provide the best possible air quality at the considered location:

Air quality is affected by several parameters like local emissions, dust or odours. Therefore it is recommended to dispose the fresh air intake at the appropriate side of the building with the right filter quality. The filter quality depends on the desired indoor air quality and the local outdoor air quality (see EN 13779). The conception of the system and the used material may also influence the indoor air quality. Additionally several hygiene formalities have to be complied to achieve a long life system (see VDI 6022):

- keeping all components clean inside is better than periodical cleaning effort
- All air stream components have to be installed in a way to be cleaned or replaced easily
- The supply air generates no draft effect in spaces where occupants remain

The installation of air inlet has to take into consideration possible furniture and the common area of occupants. Also the choice of the appropriate outlet is important to avoid draft effects. The temperature of the supply air at the inlet should be above 17°C.

- the noise from the ventilation system is not noticed in the sleeping and living areas (in some countries it may be requested to indicate whether the system is working. This requirement can be solved noiseless, using for instance luminous signals or displays.)

One of the most important requirements is a silent system in sleeping rooms. Also in living rooms noise should not be considered disturbing. A noisy system would not be accepted and it is difficult to reduce the noise after the system has been installed. In toilets or baths the requirements are not so high.

- in combination with an air tight building the ventilation systems contribute to a major reduction of the heating energy demand when used in combination with heat recovery

Air tightness has to be tested to enable good indoor air quality and low energy losses. This means only high efficient ventilators have to be used. Additionally pressure drop in the ducts has to be minimised to reduce electricity demand. The ventilation unit should enable an efficient heat recovery (minimum 60% without condensation, testing conditions in EN 13141-7 for units in dwellings). Often influence comes from un-insulated cold pipes in conditioned zones or warm pipes in unconditioned zones. So pipes with heat transfer to the ambient room should be as short as possible and well insulated.

- the installation of ventilation system is done by taking into consideration other systems dealing with air (ovens, exhaust hoods, centralised vacuum cleaners,...) to avoid dangerous situations or failures

To avoid low indoor pressure (more than 4 Pa difference to outside) the incoming and outgoing air mass flows have to be balanced. If ovens have an influence on the indoor air, a safety system has to prevent the suction of exhaust gas caused by unbalanced air systems. For all modern households circular cooker hoods, indoor air independent ovens and applicable ventilation units are recommended.

- the ventilation system can be operated easily and the user can change the filter by himself, if the unit is in his dwelling

The number of control functions a user should have is discussed frequently. Austrian experts recommend the possibility to switch the system in minimum 2 steps to adapt the desired air quality. Lowering the air rate when users are absent should be controlled automatically by CO<sub>2</sub>-sensors or can also be realised by defining time schedules (applicable for periodical absence).

- the ventilation system should be designed and realized by certified (skilled) planners and installers to achieve a very good cost-benefit ratio and an efficient support

In Austria and Switzerland a special training programme for installers was developed with the goal to raise the quality of ventilation systems. The optional personal certification is an effective marketing instrument and gives the customers a high reliability by contracting the installation of a system.

Many companies offer only parts of ventilation systems but don't provide any support. Certified installers have the task to advise their customers and offer service for the whole lifetime of the system.

- basis for the design, realization and operation of the ventilation systems are the national norms, local requirements (e.g. fire protection) and defined technical quality criteria (55 quality criteria for comfort ventilation systems)

The term "comfort ventilation" (from the German "Komfortlüftung") refers to a specific mechanical ventilation concept complying with specific qualitative quality criteria for residential buildings. Among Swiss and Austrian experts, it is considered to represent the ideal ventilation system in residential buildings. Since it does not refer to quantitative criteria, the term "comfort ventilation" might be used at an international level.

In practice and because of specific buildings and users characteristics, ventilation systems combine the features of central and decentral ventilation systems. Ventilators can be installed centrally and heat exchangers in each dwelling, or each dwelling might be equipped by individual ventilators whereas large heat exchangers might be installed at a centralised place.

### 5.5.5 Parameters guiding the choice of a concept for a ventilation system

The design of ventilation systems for renovated buildings highly depends on the building and user characteristics. On the other side, the design requirements and practices still strongly depends on national regulations and building codes. So it is not possible to provide general recommendations specifying for instance which type of ventilation system has to be used in which situation.

- **Conventional approach and proposed approach**

The conventional design approach consists in considering first the eventuality of using ventilation through window openings and in a second step the possibility of mechanical ventilation units, only if required air changes can not be insured by using window openings.

The proposed approach consists in changing the order in which the different alternatives are considered:

Given the high air tightness of buildings which have been renovated, a mechanical ventilation system should be installed when possible in order to guarantee high internal air quality. If possible, a comfort ventilation system should be analysed as first alternative. If this solution can not be implemented, other solutions can be analysed (exhaust ventilation systems...). Ventilation through manual opening of windows should be considered as last solution. In an airtight building after renovation, manual window opening can not guarantee a hygienic internal quality nor a good thermal energy performance. However, a general approach for the design of ventilation systems can be proposed as well as a list of the main influence parameters which have to be taken into consideration when designing a ventilation system in a renovation project. It is difficult to identify the relevant key parameters supporting one ventilation concept rather than one other. In many cases it is the combination of different parameters which guide the choice towards one solution rather than the other. However it is possible to describe how far single parameters can guide the choice towards one concept rather than another.

- **Ownership structure**

The ownership structure in an apartment building can be determinant for the degree of centralisation of the components of ventilation systems. In co-ownerships where each flat belongs to a different owner it is difficult to think about a centralised system, mainly because of there are many incompatibilities between the ownership structure and the organisational issues linked with the implementation of a centralised ventilation system (high investment costs, responsibility for operation and maintenance etc.). Decentral ventilation systems are more adapted in those situations.

- **Maintenance effort**

The effort necessary for maintaining the ventilation system is proportional to the number of filters to be regularly replaced. In an apartment building where filters are installed at the supply air duct for each dwelling, the best situation is when filters can be accessed directly from the common parts of the building, in order to avoid maintenance staff going inside the dwellings to replace old filters.

- **Climate conditions**

Climate conditions can be decisive while choosing between individual ventilation units and a central ventilation system supplying many dwellings. Heat recovery devices (heat ex-



changers) have to be protected from frost. If individual units are not equipped with preheaters to prevent heat exchangers from frost damages, the devices should not be used, which limits the time when the rooms are ventilated. Central devices can be usually equipped with preheaters, so that the ventilation systems can be operated also during times with  $T_{air} < 0^{\circ}\text{C}$ .

- **Total costs**

In buildings where renovation costs have to be kept at a particularly low level (e.g. in the social housing sector), it is not always possible to implement comfort ventilation systems (supply and exhaust systems) which are characterised by particularly high investment costs. In such conditions, humidity controlled exhaust air systems can be particularly convenient, while maintaining the energy performance of the building in acceptable levels (see publication Geneva). To control the air flow of exhaust air ventilation systems it is necessary to guarantee a particularly high air tightness of the building envelope; this is not easy to reach during renovation works.

- **Architectural limitations**

The architectural characteristics of the building and in particular the space available for air ducts is decisive while analysing the feasibility of comfort ventilation system requiring supply and exhaust air ducts.

- **Size of dwellings**

The size of dwellings and in particular the number of rooms (not all dwellings provide the possibility to have separated fresh air supply and exhaust air zones) are important factors while designing the ventilation system. Not all dwellings at one floor need to be equipped by the same type of ventilation system. Very small dwellings can be equipped with individual ventilation units whereas bigger dwellings can have supply and exhaust air ducts.

### 5.5.6 Definitions / glossary

#### comfort ventilation system

A comfort ventilation system for residential buildings is a supply and exhaust ventilation system with heat recovery which is designed, realized and operated in a way to obtain maximal comfort, hygiene and energy savings. A comfort ventilation system is characterized through following points:

Ventilation systems can be characterised in function of the degree of aggregation of the single components constituting the system. The terminology central/decentral/semi-central can be used but need to be defined carefully.

#### central ventilation system

A central ventilation system consists of a central ventilation unit grouping all main components of the system (ventilators, heat exchangers and filters) at one place. For an apartment building, the central unit is connected to every single apartment through supply and exhaust pipes.

#### decentral ventilation system

A decentral ventilation system consists of many distributed ventilation units installed directly in the rooms or dwellings to be ventilated. At the scale of an apartment building, it means that every apartment has its own ventilation unit.

#### semi-central ventilation system

In practice and because of specific buildings and users characteristics, ventilation systems combine the features of central and decentral ventilation systems. Ventilators can be installed centrally and heat exchangers in each dwelling, or each dwelling might be equipped by individual ventilators whereas large heat exchangers might be installed at a centralised place.

### References

- [55] PROJECT: **Technical status of ventilation systems for buildings**; Austrian Program on Technologies for Sustainable Development, funded by "Federal Ministry for Transport, Innovation and Technology" (BMVIT), 2004 Project leader: FHS-KufsteinTirol  
more information:  
<http://www.hausderzukunft.at/results.html/id2804>

- [56] Web site on comfort ventilation systems, more information:  
[www.komfortlüftung.at](http://www.komfortlüftung.at)

## Authors

Olivier Pol  
Austrian Institute of Technology  
[Olivier.Pol@ait.ac.at](mailto:Olivier.Pol@ait.ac.at)



Wolfgang Leitzinger  
Austrian Institute of Technology  
[wolfgang.leitzinger@ait.ac.at](mailto:wolfgang.leitzinger@ait.ac.at)



This chapter is carried out in the framework of the Austrian participation in the Energy Technology Programme of the IEA and funded by the Austrian Ministry for Transport, Innovation and Technology.