

**Sheikh Zayed Desert Learning Center**

**iC**

**CES**

Innovative Gebäudetechnik

Klaus Kogler  
11.06.2014

- iC clean energy solutions GmbH => ab 2014: CES clean energy solutions GmbH
- Hintergrund: Expertenteam für “Neue Dienstleistungen” der iC group of companies im Bereich Energie und Umwelt
- Abteilungen:
  1. Innovative Gebäudetechnik, F&E
  2. Energieeffizienz
  3. Wasserkraft
  4. Anlagenbau
  5. Umwelt

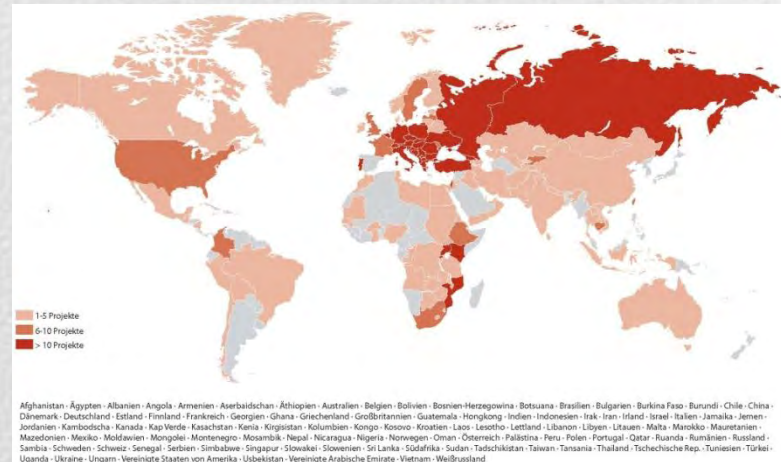

- Klaus Kogler
- Gruppenleitung Innovative Gebäudetechnik, F&E
- Leitender Experte:
  - Gebäudezertifizierung, LEED, BREEAM; ÖGNB; ÖGNI; DGNB  
Green Building, Estidama, QSAS
  - Energieeffizienz  
Low Carbon MEP Design, Revit/BIM Services,... in Neubau und Bestand
  - Innovationsmanagement  
Lebenszykluskostenverifizierung (durch Monitoring), Energie,  
Energieeffizienz, Smart Cities und Technologieberatung
- Kontakt:
  - [k.kogler@ic-group.org](mailto:k.kogler@ic-group.org)
  - [k.kogler@ic-ces.at](mailto:k.kogler@ic-ces.at)

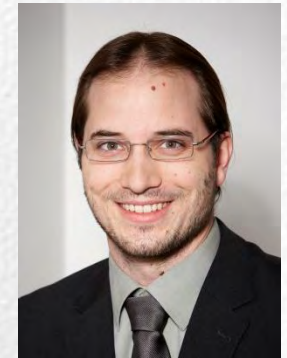



- Man sieht sie nicht
- Man hört sie üblicherweise nicht
- Man spürt sie nicht, außer es funktioniert etwas nicht



- 25 % - 50 % der Investitionskosten fließen in die TGA
- ca. 80 % der Objektfolgekosten resultieren aus der TGA und sind hierüber beeinflussbar



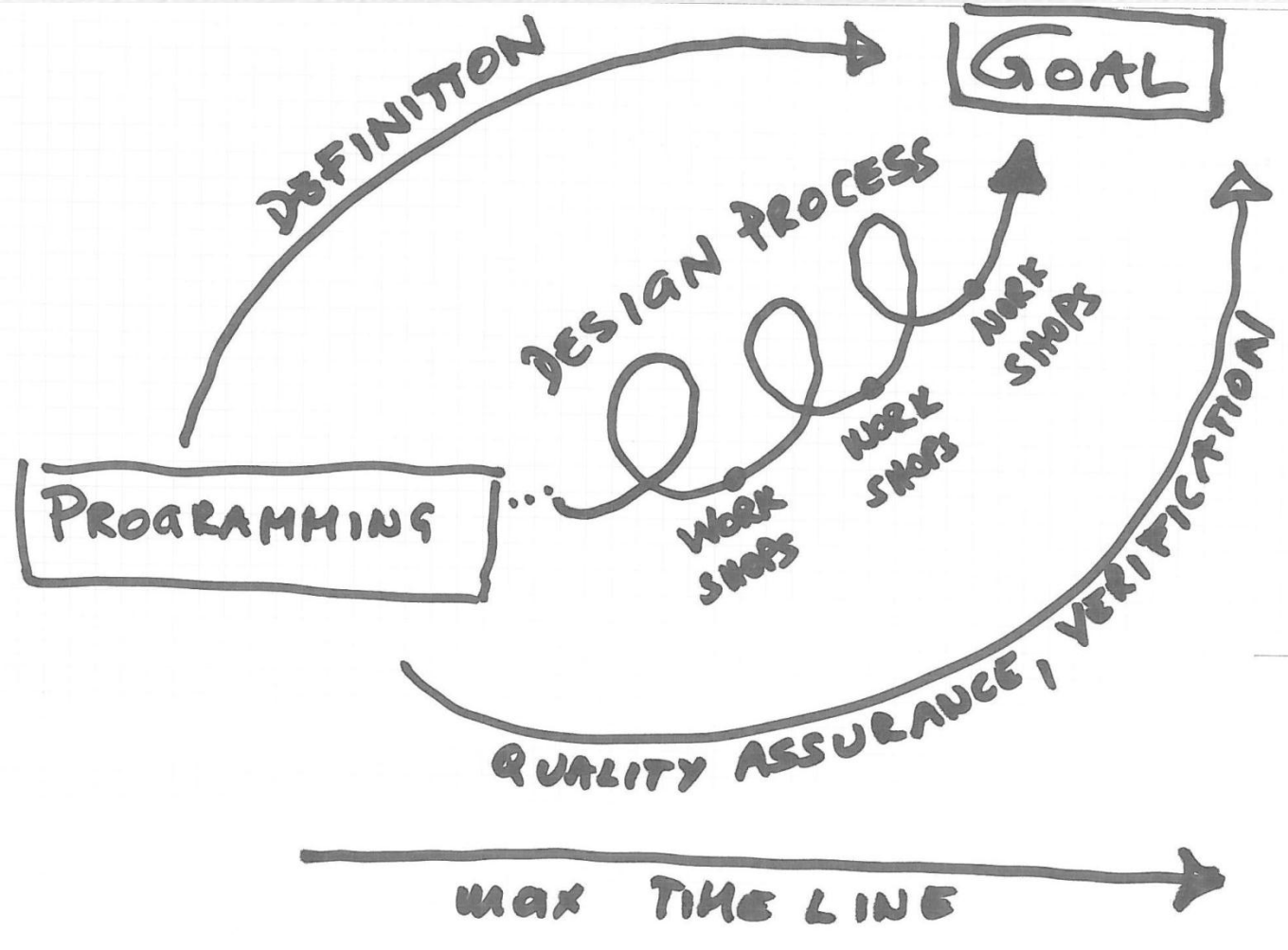



## MEP Coordinated Detailed Design

Key components of MEP design are listed in vertical order below. On the horizontal axis events with significant influence on at least one field of activity are listed. A change in colour indicates a change in the basic concept within the respective field. Thus the table below shows the most significant changes on the conceptual design during the overall design process, till 100 % coordinated detailed design.

	Variety of technologies available (MEP concept status)	MEP Workshop, Vienna, 29.08.2008	MEP, Water Summit in Al Ain, 13. - 16.09.2008	MEP Workshop, Vienna, 07.10.2008	MEP Workshop, Vienna, 24.10.2008	MEP 50 % Schmatic Design , 06.11.2008	MEP 100 % Schmatic Design , 17.12.2008	MEP 100 % Coordinated Detail Design, 08.05.2009
HVAC, Air Intake and Ventilation	Mechanically forced ventilation, also throughout the exhibition areas	No change	No change	No change	No change	No change	No change	Mechanically forced ventilation, also throughout the exhibition areas
	Natural ventilation for exhibition areas	It is expected being technically not feasible						
	Natural ventilation with climatic zones for exhibition areas	No change	No change	It is expected being technically not feasible				
	Concrete core activation, water/air based	No change	No change	No change	No change	No change	Concrete core activation, water/air based	Concrete core activation, water based
HVAC, Cooling System	Free cooling via utilization of ground water	No change	No change, but discussion on availability of ground water	No change, but discussion on availability of ground water	No change, but discussion on availability of ground water	No change, but discussion on availability of ground water	Free cooling via utilization of ground water	No utilization of ground water due to legal restrictions
	Conventional, chiller based	1. choice backup for solar cooling, ca. 50 % coverage	Increase to 100 %, but ecological operation mode via solar cooling	100 % load coverage, but bivalent mode via solar cooling	No change	No change	No change	100 % load coverage, but bivalent mode via solar cooling
	Solar cooling, water based	1. choice covering primary load	Solar cooling for ecological operation mode, ca. 30 % coverage	300-400 kW solar cooling for concrete core activation and eco-mode	No change	No change	No change	300-400 kW solar cooling for concrete core activation and eco-mode
	Solar cooling, electricity based	No change, remains as an option	No change, remains as an option	Photovoltaic for pump operation and lighting only	No change	No change	No change	Photovoltaic for pump operation and lighting
	Solar cooling, Fresnel	No change, remains as an option	No change, remains as an option	Technical feasibility => preference is given to solar cooling water based				
				Introduction of air based free cooling	No change	No change	No change	Air based free cooling
				Introduction of desiccant recuperation wheels	No change	No change	No change	Desiccant recuperation wheels
Sanitary and Sewage System	Standard installations	Stormwater, greywater reuse, blackwater to sewer	No change	Stormwater, greywater reuse, blackwater treatment via local facility	No change	No change	Stormwater, greywater reuse, blackwater treatment via local facility	Stormwater, greywater reuse
	Water saving installations, incl. water free urinals	No change	No change	Vaccum based water saving installations	No change	No change	Vaccum based water saving installations	Vaccum based water saving installations, and water free urinals
Electrical Engineering, BMS	Energy efficient lighting	No change	No change	No change	No change	No change	No change	Energy efficient lighting
	BMS	No change	No change	No change	No change	No change	BMS	BMS incl. predictive weather control
Fire Protection	Sprinkler System	No change	No change	No change	Water mist system throughout the building	Water mist system throughout the building	A mixture of mist and sprinkler system has to be applied	A mixture of sprinkler and inert gas has to be applied
	Mechanically forced smoke removal in the atrium	No change	No change	No change	Mechanically forced smoke removal required in one storehouse only	Mechanically forced smoke removal required in one storehouse only	Pressurised stairhouses and forced smoke removal in certain areas	Pressurised stairhouses and forced smoke removal in certain areas
	Increase in number of fire compartments	No change	No change	No change	Number of fire compartment can significantly be reduced	No change	No change	Number of fire compartments can significantly be reduced

- Lüftung
- Klimatisierung
- Sanitär
- Elektrotechnik
- Gebäudeleittechnik
- Simulationsleistungen
- Brandschutz
- Sicherheitstechnik
- Kommunikationstechnik
- Bauphysik
- Akkustik



17+ Fachbereiche, 15 Senior Staff, 25 Engineers



# Wo beginnen wir?

- Definition der Anforderungen / Kundenwunsch (21/40 bei 45/33)
- LEED Platinum, Estidama 5 Pearls
- Zonenmodell
- Belegungsprofile
- Lastprofile
- Bauphysik
- Gebäudetechnik
- Simulationen

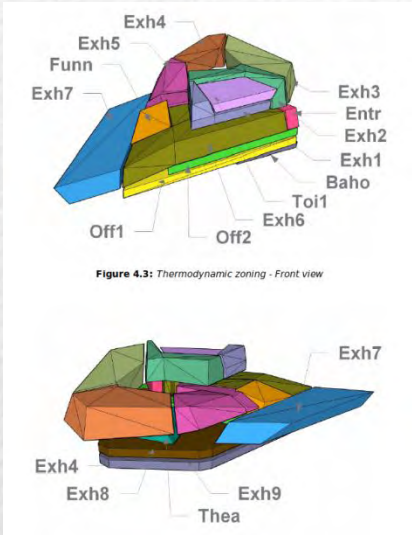
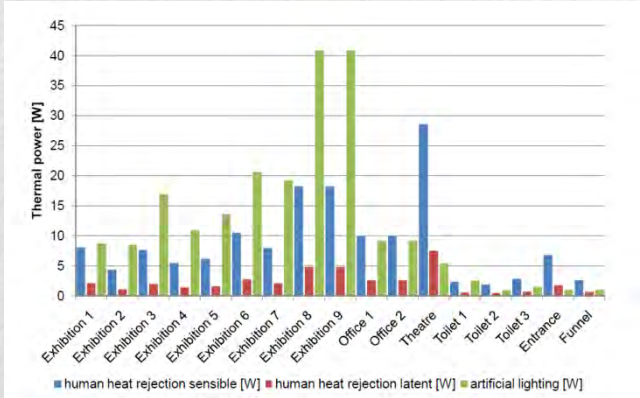

Figure 4.3: Thermodynamic zoning - Front view



- Erstmalige Implementierung von Vacuumtoiletten im Emirat Abu Dhabi
- Erstmalige Implementierung eines Erdwärmetauschers in den VAE
- Erstmalig Betonkernaktivierung mit einer Fläche von über 100 m<sup>2</sup>
- Erstmalige Verwendung von Adiabatischen Kühltürmen
- Die erste funktionierende Solarthermische Absorptionskühlung in den VAE

## Wasser (1 m<sup>3</sup> Trinkwasser = 4 kWhel)

- 80 % Einsparung an Trinkwasser durch
  - Verwendung von gereinigtem Wasser der Kläranlage für die Rückkühlwerke
  - Aufbereitung von Grauwasser
  - Energiespararmaturen und Vacuumtoiletten
  - Verwendung des Kondensatwassers aus den Lüftungsanlagen
  - Verwendung von Regenwasser





# Wassereinsparung Kühlturm

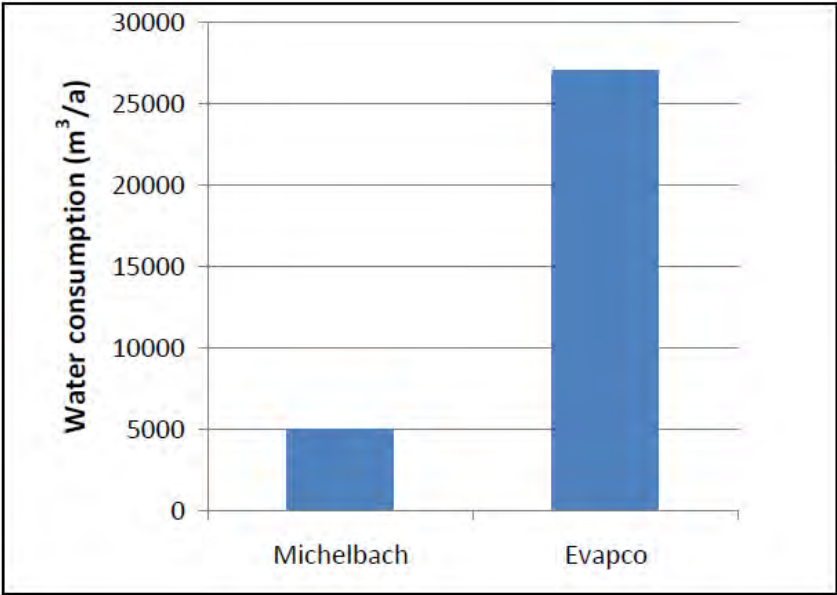
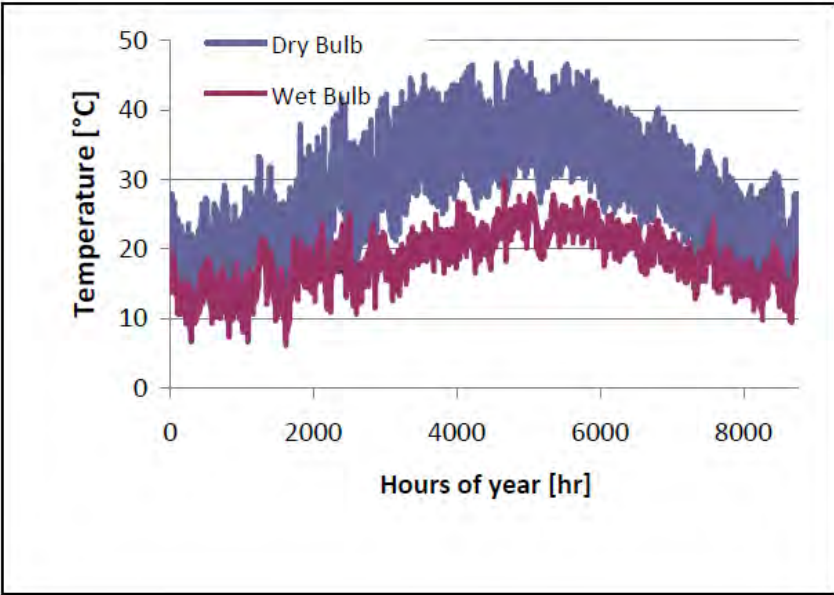

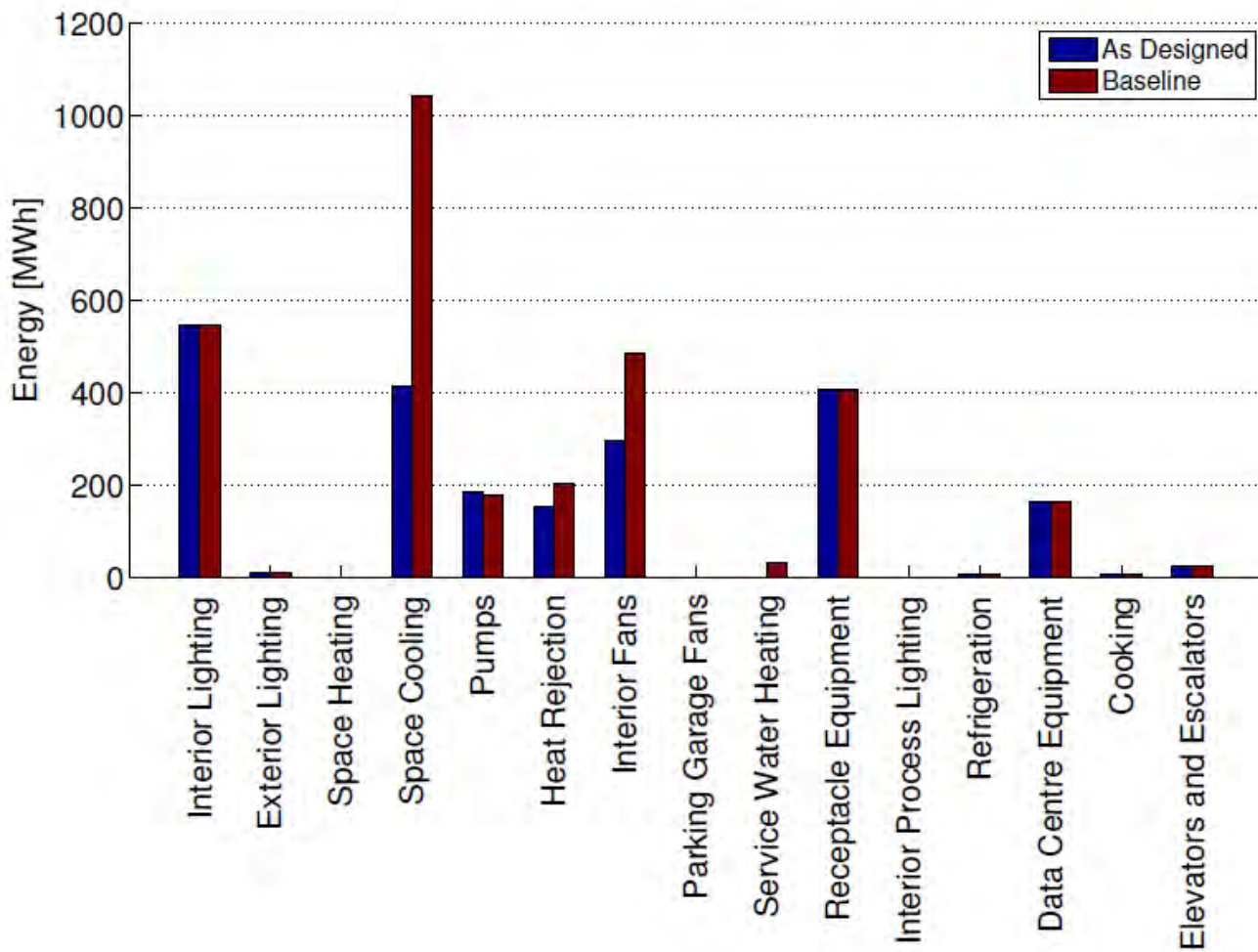

### LEED Envelope Energy savings

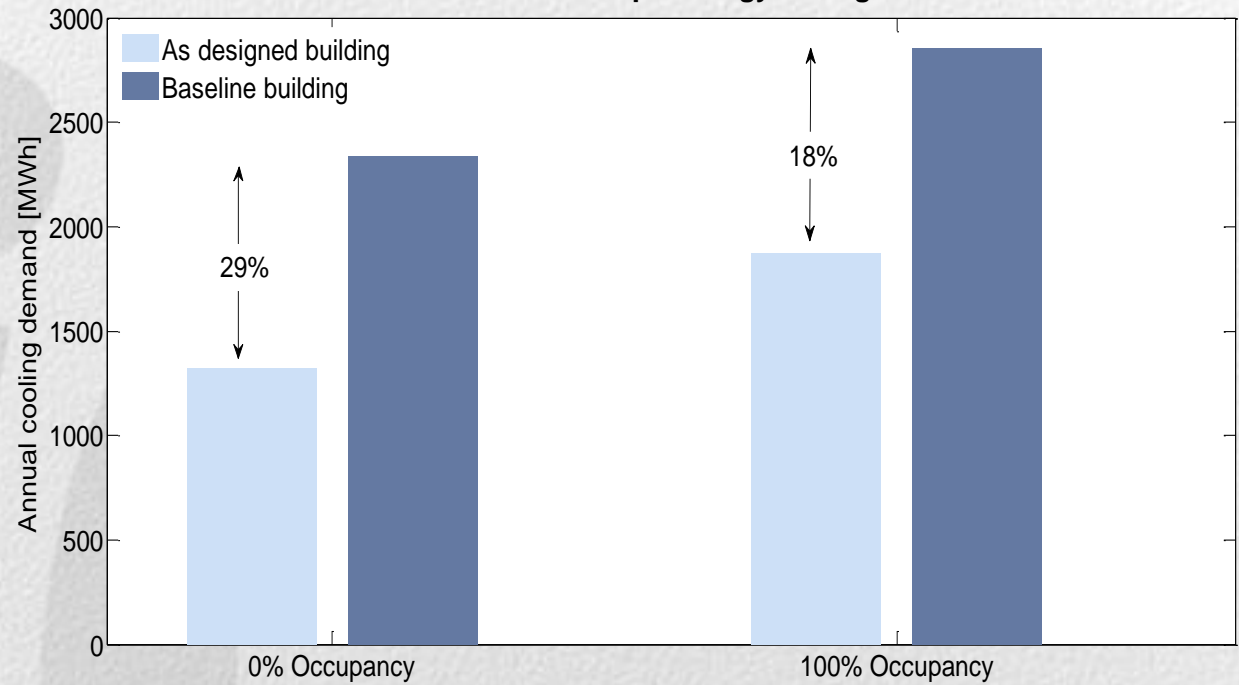





CES

# Lüftung

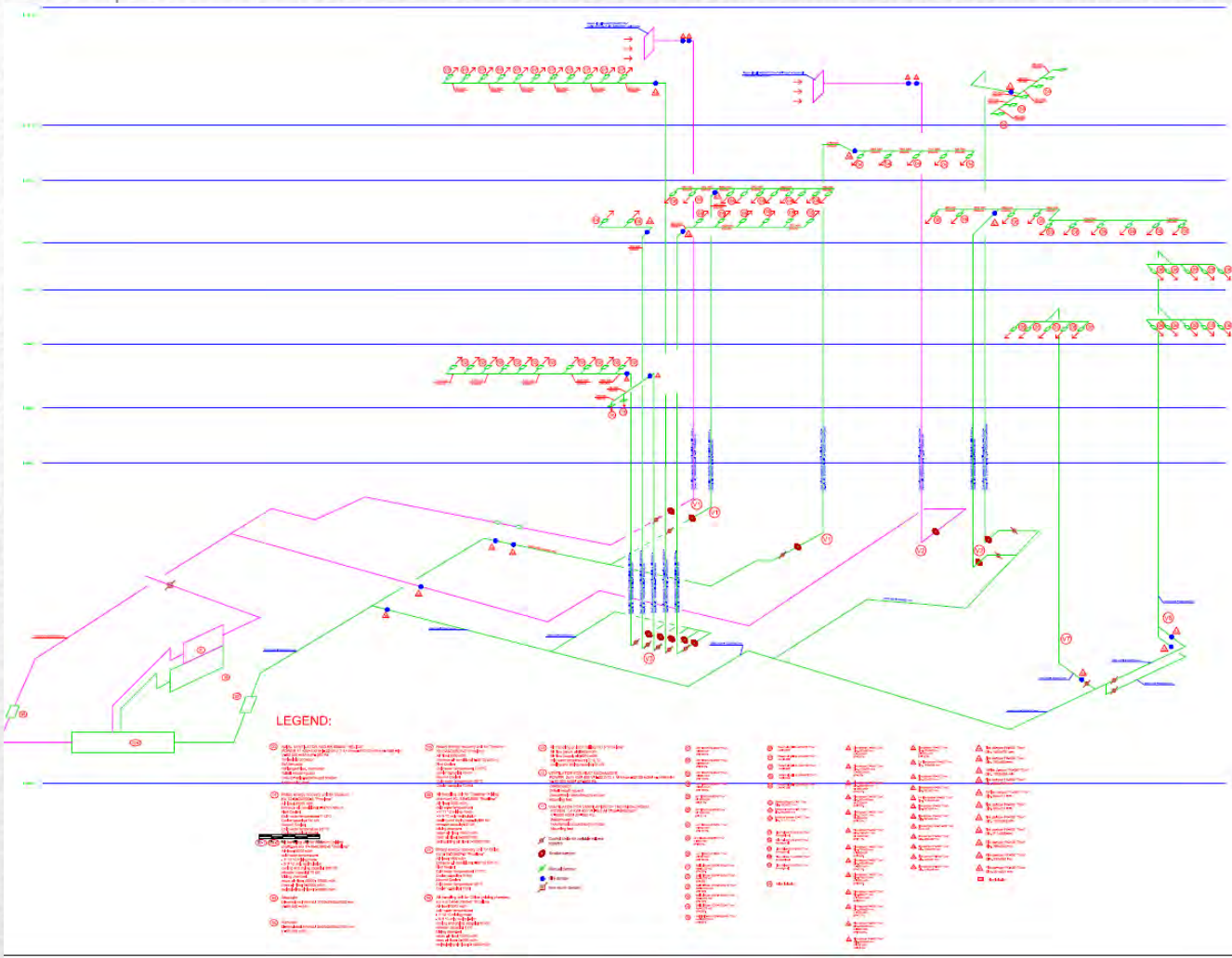

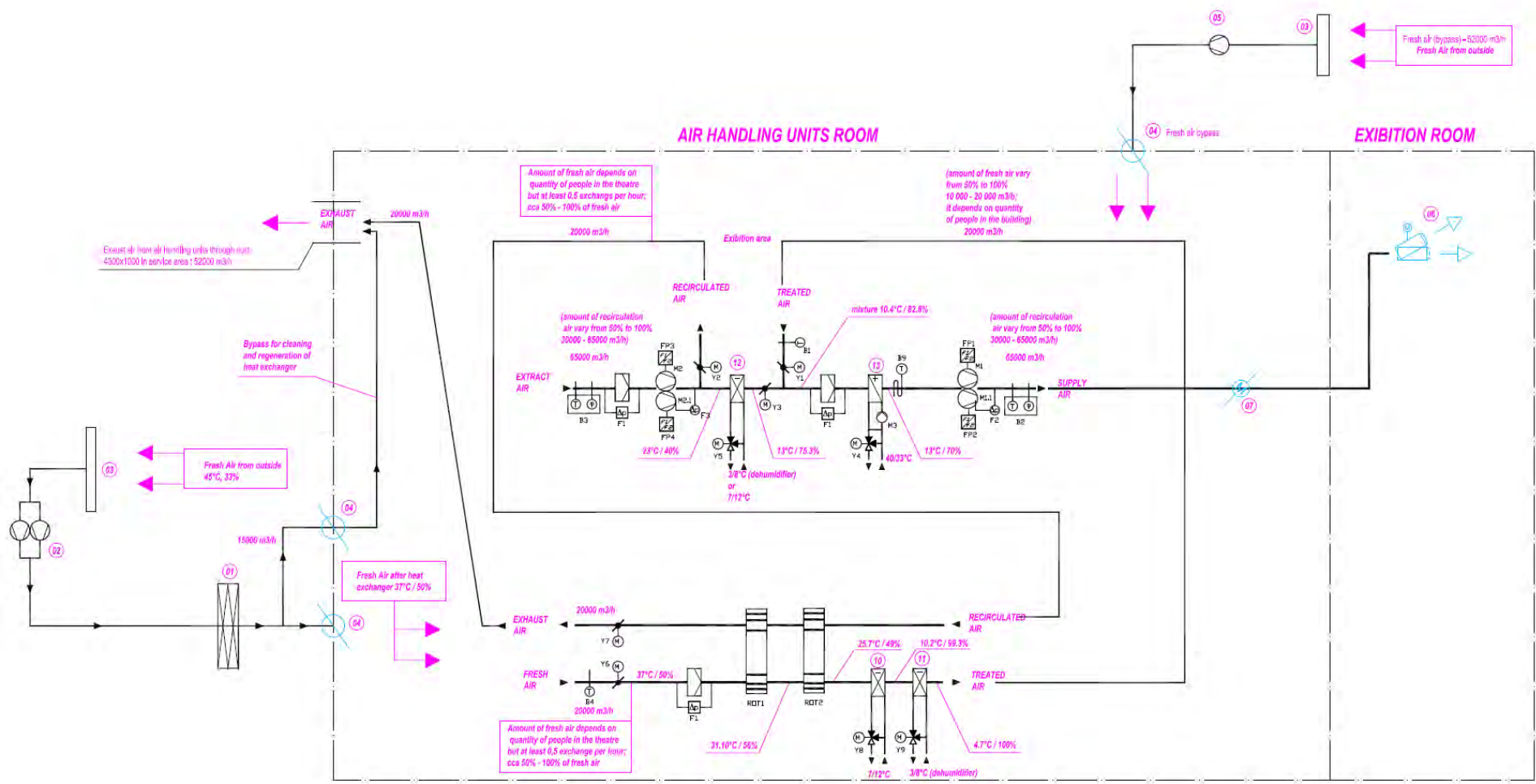



- 1200 m Tunnel / Rohrsystem
- max. 60.000 m<sup>3</sup> / h
- Delta T up to 10 K
- Approx. 120 MWh<sub>th</sub> savings

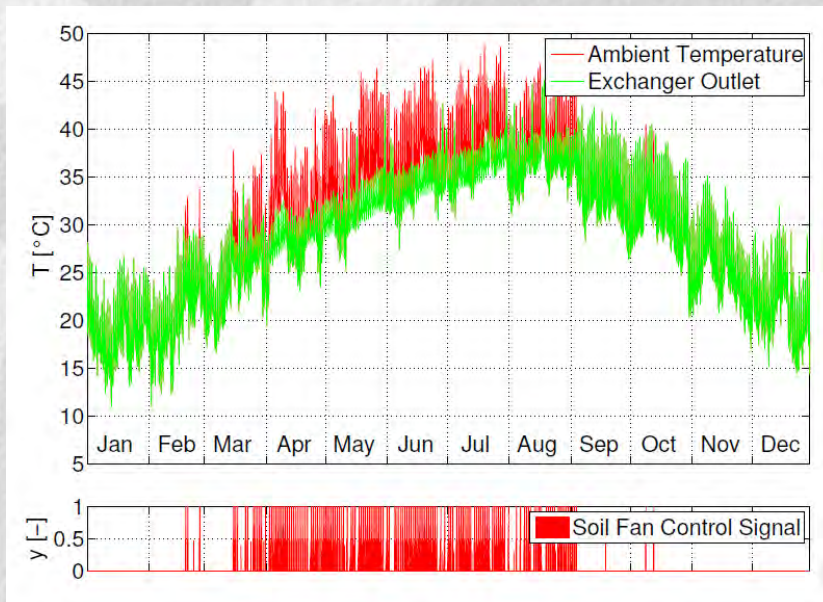





# Solare Absorptionskälte (COP 0,90!!)

Al Ain - SZDLC Al Ain



**SCHNEID** GesmbH

2013-11-12 16:20:56

37.5 °C  
ambient temperature

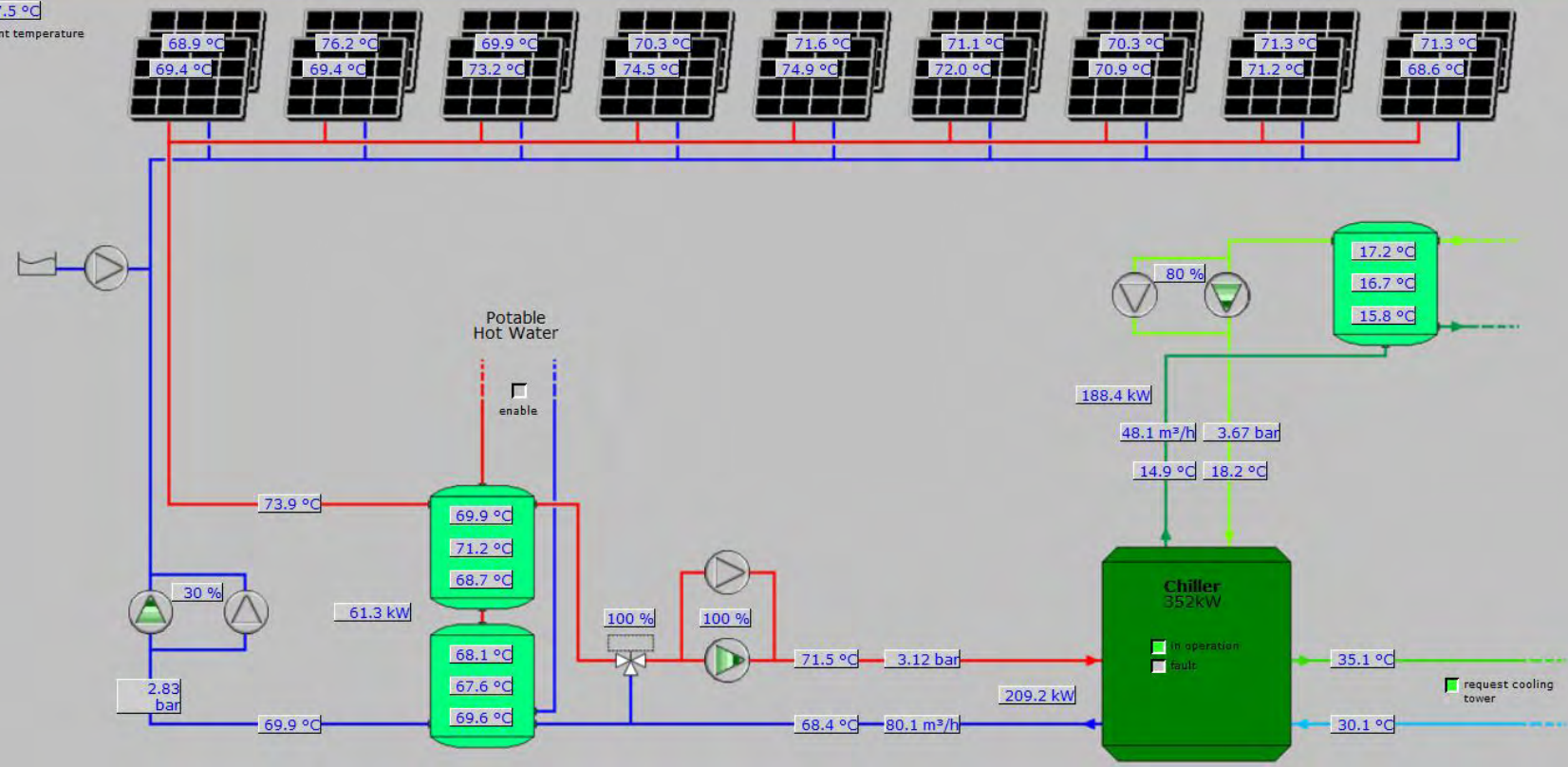

<http://alain.heizwerk.at/?email=free&pw=free>







- ✓ Herausragendes Gebäude mit internationaler Strahlkraft
- ✓ Österreichisches Planungs-Knowhow im Export
- ✓ Neue Technologien wurden implementiert
- ✓ ca. 40 % reduzierter Endenergieverbrauch
- ✓ ca. 80 % weniger Wasserverbrauch
- ✓ LEED Platinum Design
- ✓ Estidama 5 Pearls rating achieved

The logo for CAP, consisting of the letters 'CAP' in a blue, sans-serif font.The logo for AIT, featuring the letters 'AIT' in a bold, grey, sans-serif font, with 'AUSTRIAN INSTITUTE OF TECHNOLOGY' in a smaller, red, sans-serif font to the right.The logo for BOLLINGER + GROHMANN, featuring the text 'BOLLINGER + GROHMANN' in a bold, black, sans-serif font, with 'Ingenieure' in a smaller, black, sans-serif font below it.

...das Gebäudeverhalten rückt in den Mittelpunkt

Danke für Ihr Interesse!