

IN THIS ISSUE:

**Refrigerant
Charge in
Heat Pumps**

**A Tool
for LCCP**

**Low GWP-
Alternatives
to R410A**

**Experience of
Refrigerant
Restrictions**

**Risk Study of
Mildly Flammable
Refrigerants**

IEA HEAT PUMP CENTRE

NEWSLETTER
VOL. 31
NO. 3/2013



Environmental evaluation of heat pumps as products

In this issue

Heat Pump Centre Newsletter, 3/2013

The subject of refrigerants is always hot. This concerns choice of refrigerant as well as refrigerant charge, for a given application. Also, in the light of the climate debate, it may be argued that the Global Warming Potential (GWP) is not the only factor to take into account; for instance, the use of electric energy during the lifetime of a heat pump also needs to be considered.

Environmental evaluation of heat pumps as products is the topic of this issue of the HPC Newsletter, with an emphasis on refrigerant choice and minimal charge. After a review article of work on charge analysis and reduction, a tool for LCCP-based design of heat pumps is presented. The next two articles each present examples of refrigerants, alternatives to more traditional refrigerants. The final topical article presents the European experience of restrictions of some refrigerants. Non-topical articles in this issue include a summary of the recent ASHRAE meeting, as well as a presentation of the newly formed Swedish Centre for Shallow Geothermal Energy.

Enjoy your reading!

Johan Berg
Editor

COLOPHON

Copyright:
© IEA Heat Pump Centre

All rights reserved. No part of this publication may be reproduced, stored in a retrieval system, or transmitted in any form or by any means, electronic, mechanical, photocopying, recording or otherwise, without prior written permission of the IEA Heat Pump Centre, Borås, Sweden.

Published by IEA Heat Pump Centre
Box 857, SE-501 15 Borås, Sweden
Phone: +46 10 516 55 12

Disclaimer IEA HPC
Neither the IEA Heat Pump Centre, nor any person acting on its behalf:

- makes any warranty or representation, express or implied, with respect to the accuracy of the information, opinion or statement contained herein;
- assumes any responsibility or liability with respect to the use of, or damages resulting from, the use of this information

All information produced by IEA Heat Pump Centre falls under the jurisdiction of Swedish law.

Publisher:
IEA Heat Pump Centre
PO Box 857, S-501 15 BORAS
SWEDEN
Tel: +46-10-516 55 12
E-mail: hpc@heatpumpcentre.org
Internet: <http://www.heatpumpcentre.org>

Editor in chief: Monica Axell
Technical editors: Johan Berg, Roger Nordman,
Caroline Stenvall - IEA Heat Pump Centre
Language editing: Angloscan Ltd.

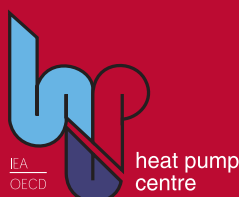

Heat pump news

IEA Heat Pump Programme News.....	5
General.....	6
Policy.....	6
Working Fluids.....	7
Markets.....	8
IEA HPP Annexes.....	9

Regulars

Foreword	3
Column	4
Events.....	43
National Team Contacts	44

Topical articles

Refrigerant Charge in Heat Pumps – Part I Charge Inventory Analysis and the advent of charge reduction	15
A Tool for Life Cycle Climate Performance (LCCP) Based Design of Residential Air Source Heat Pumps	21
Risk assessment study of mildly flammable refrigerants.....	26
Low GWP R410A Alternatives in Heat Pumps: Performance and Environmental Characteristics.....	31
European experience of CFC, HCFC and HFC restrictions.....	35
Non-topical articles	
A new centre for Swedish shallow geothermal energy.....	38
Summary of 2013 ASHRAE Annual Meeting.....	41

Environmental evaluation of heat pumps as products



*Oliver Sutton
Department of Energy and Climate Change
(DECC)
London
United Kingdom*

The UK has some of the most challenging and ambitious targets for reducing CO₂ emissions, with a headline target of 80 % reduction in emissions by 2050. The UK has enjoyed decades of natural gas, primarily from the North Sea, and has made good use of this energy source to power the nation's heating needs. In 2010, 93 % of central heating systems were using gas¹. This is in contrast to most other European countries, except the Netherlands, who have high proportions of electrically powered heating, often associated with much lower electricity grid carbon intensity. This dominance of the gas boiler in the UK has reduced CO₂ emissions from domestic heating, switching away from oil, coal, electric and other solid fuels. However, if we are to achieve our CO₂ emission reduction targets, we must decouple our heating from natural gas. Part of the solution is heat pumps.

The current mix of the UK electricity grid is predominantly generation from coal (39 %), gas (28 %) and nuclear (19 %)² but with an ever increasing share of renewable electricity (11 %). With this generation mix, heat pumps currently have to achieve efficiencies of at least SPF 2.3 to be lower carbon than a condensing gas boiler (90 % seasonal efficiency assumed). The ambition is that, with the addition of new nuclear generation and ever increasing proportion of renewables, a low carbon grid can also decarbonise a large portion of the domestic heating sector with heat pumps.

However, it is important to remember that the CO₂ emissions from the power station used to drive the heat pump are not the only emissions to contribute to climate change. The most common refrigerants used in domestic sized heat pumps are R134a (GWP 1430), R407C (GWP 1774) and R410a (GWP 2088), which is a blend including R134a. The high global warming potential (GWP) of these gases can therefore result in significant CO₂ equivalent emissions if any of this gas leaks to the atmosphere. For example, assume that a domestic size heat pump which has a refrigerant charge of 3 kg using R410a with a GWP of 2088 had a fault and leaked 50 % of the refrigerant charge half way through its operating life. This would effectively emit the equivalent of around 3100 kg CO₂. To put this in context, the lifetime CO₂ emissions reduction for the same system if we assume a SPF of 3 having replaced a gas boiler in the UK and a lifetime of 15 years would be approximately 11 100 kg CO₂. Therefore a total loss of refrigerant could drastically reduce any reduction in CO₂ emissions resulting from the replacement of a gas boiler by a heat pump. Whilst this is clearly just an illustrative example, it puts into context the importance of minimising refrigerant leakage. This is particularly important for the UK as our current electricity grid has a high carbon intensity relative to most other European countries with strong heat pump markets, so any additional emissions from F-gases can make the difference between CO₂ reduction or not.

There has been a great deal of effort to ensure F-gases do not leak from heat pumps, or any equipment that carries refrigerants for that matter. However, there is more that can be done: better leak detection, lower refrigerant charge required and using refrigerants that do not carry such high global warming potential.

This newsletter will highlight some of the current issues in this area and much of the excellent research that is being carried out to ensure the whole environmental impact of heat pumps is acknowledged and minimised. This newsletter will highlight some of the current issues in this area and much of the excellent research that is being carried out to ensure the whole environmental impact of heat pumps is acknowledged and minimised.

¹ UK Housing Factfile 2012

² Digest of UK Energy Statistics 2013

Heat Pumps and Additive Energy Systems



Mr. Stephan Renz
Head of Heat Pump Research Program
Swiss Federal Office of Energy
Switzerland

Heat pumps have reached a high state of technical development and are used in large numbers throughout the world as very efficient heat-generating systems. Nevertheless there are various challenges that have to be met and these have led to the demand for greater research and development. The following objectives can be formulated as a consequence of this demand:

- Improvement of the thermodynamic cycle to increase the quality of systems
- Improvements in components and reduction in costs for the overall system
- Optimisation of control strategies, for example for partial load or for handling variable temperatures in heat sources and heat sinks
- High temperatures (>100 °C) for use in industry
- Environmentally conform and thermodynamically efficient coolants
- Overall system optimisation and consideration of additive energy systems

Additive energy systems are now being increasingly used in combination with heat pumps, which is why I want to go into more detail. Among the actual energy systems I differentiate between internal and external additive energy systems, both of which may be used in combination. The internal systems include solar thermal plants¹, photovoltaic systems, conventional furnaces using fossil fuels or renewable fuels or cogeneration plants that generate power and high grade heat. Energy stores are significant components in the various combinations of additive systems with heat pumps. Such are utilised as either heat stores on the heat sink side or as cold stores on the heat source side and thus serve to balance out supply and demand.

Energy stores also play an important role in the combination of heat pumps with external additive systems. These include systems for power generation with variable types of renewable energy carriers, such as solar energy and wind energy². As a rule such supply sources tend to fluctuate according to the season or in the course of a day or even vary greatly in places over short periods of time as a result of the weather. To guarantee the power supply at all times and to stabilise the grids controllable power generating units will have to be constructed or the excess power from wind power will have to be capped. In Germany in 2012 the excess power amounted to 2.9 TWh.

If heat pumps could be operated increasingly at times when power is available, excess power could be used and the economic viability of systems be further improved.

The idea of operating heat pumps at times when power is available is not exactly new. More than 30 years ago in Switzerland large heat pump systems were equipped with heat stores and operated during the night using cheap power from large base load power plants.

Optimised operation of heat pumps that are dependent on internal and external additive energy systems is much harder to achieve and cannot be limited to just switching from simple day or night operation. Smart grids are necessary with refined control systems for the heat pump building system³. Such systems should be operated optimally from a technical and an economic standpoint. Taking into consideration the numerous variables this is a major challenge for research and development.

1 IEA Heat Pump Programme Annex 38 «Solar and Heat Pump Systems»
2 Grid Integration of Variable Renewables (GIVAR), IEA, June 2013
3 IEA Heat Pump Programme Annex 42 «Heat Pumps in Smart Grids»

IEA Heat Pump Programme News

Over 300 abstracts received for the 11th IEA Heat Pump Conference



Over 300 abstracts from 31 countries have been submitted for the 11th IEA Heat Pump Conference to take place in Montréal from May 12-16, 2014. The Regional Coordinators had the difficult task of reviewing all of them in a very tight timeframe. The review was finalized in early September and authors have now been informed about acceptance of their proposal. With so many submissions, the conference promises to be extremely well attended with delegates from all over the world to discuss a very broad range of heat pump applications.

The final allocation of the presentation style (oral presentation or poster presentation) as well as the preliminary conference schedule will be decided by the International Organizing Committee (IOC) at their next meeting in November. The workshops schedule on international collaborative projects (Annexes in the IEA Heat Pump Program) will also be finalized at that time. Other po-

tential parallel events will also be discussed.

The National Organizing Committee (NOC) is currently in the process of confirming site visits to take place on Wednesday, May 14, 2014 during the conference. The information will be posted on the conference registration page once completed.

The registration page for the conference was activated mid-September, so it is now possible to register at the early bird rate. The NOC also invites delegates to book their room at the Fairmont Queen Elizabeth as early as possible if they wish to stay at the conference. Conference registration and hotel reservation instructions are available on the conference website at www.iea-hpc2014.org. The NOC also recommends to potential exhibitors to reserve their booths now in order to secure the best locations. The sponsorship and exhibition package is also available via the conference website.

Talks and know-how on heat pumps: The European Heat Pump Symposium



What role do smart grids play in the future of heat pumps and what prospects are offered by hybrid systems? The Symposium of the third European Heat Pump Summit (EHPS) on 15-16 October 2013 will provide the answers to these questions, and many others.

The Symposium, in the Exhibition Centre Nuremberg, supplies extensive information on the current state of heat pump development and research and on the European heat pump market.

At the accompanying Foyer-Expo, heat pump and component manufacturers present new products and developments that point the way to

the future of heat pumps.

For an overview of the EHPS, see <http://www.hp-summit.de/en/>

Link to the EHPS Symposium: <http://www.hp-summit.de/en/symposium/>

Heat Pump Programme seeks candidates for Rittinger award

The IEA Heat Pump Programme is announcing that nominations are being sought for the Peter Ritter von Rittinger award.

This award, presented for the first time at the IEA International Heat Pump Conference in 2005, is awarded to deserving individuals or teams who have achieved distinction in the advancement of heat pumping technologies, applications, market development and management or organization of activities with lasting international impact.

The award is named for Peter Ritter von Rittinger, an Austrian engineer who is credited with design and installation of the first practical heat pump system at a salt works in Upper Austria in 1856.

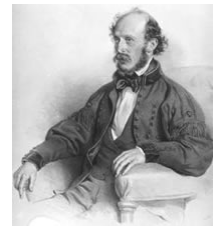

The awards will be presented at the International Heat Pump Conference 2014, which will be held in Montreal, Canada in May 2014. The deadline for nominations is the **1st of March 2014**.

For full information on the award selection guidelines and nomination applications, see <http://www.heatpumpcentre.org/en/hppactivities/rittingeraward/Sidor/default.aspx>

General

Installing heat pumps would save large fuel costs in Japan

The Heat Pump and Thermal Storage Technology Center of Japan (HPTCJ) has published the results of its tentative calculation of the potential reduction in primary energy that could be attained with the more widespread use of heat pumps. Replacing the boilers now used to meet residential and industrial demand for heat with heat pumps in Japan can save about 27 million kilolitres of crude oil and ¥2.6 trillion (about US\$ 27 billion) in fuel costs annually.

Source: JARN, July 25, 2013

The 2nd Asia Air-source Heat Pump Summit

Organized by the International Copper Association (ICA) and the China Energy Conservation Association (CECA), and sponsored by the China Refrigeration and Air-Conditioning Industry Association (CRAA), and the Shanghai Society of Refrigeration (SSR), the 2nd Asia Airsource Heat Pump Summit was held in Wuxi, Jiangsu Province, on June 19-20.

With the theme of 'Based in Asia, Care for Global Air-source Heat Pump Development, Promote Sustainable Green Economy', the summit attracted industry experts, associations, and company representatives from both China and abroad to discuss policies, new technologies, trends and hot issues of the air-source heat pump industry of the Asia Pacific region.

According to CECA, since the air-source heat pump products were included into the subsidy program of the Energy-saving Product for the Benefit of the People Project, the products have been gradually recognized and better received by consumers. The higher level of market acceptance has brought higher requirement for the product technol-

ogy. The summit plays an active role for the technological exchange of the air-source heat pump industry, and will further enhance the technology development.

During the conference, Roger Nordman, IEA Heat Pump Centre, Omar Abdelaziz from Oak Ridge National Laboratory, USA, and Takeshi Hikawa, IEA Asia Pacific coordinating expert from the Heat Pump and Thermal Storage Technology Center of Japan (HPTCJ) made the presentations 'Application and Data Analysis of the Air-source Heat Pump Technology in Europe', 'Air-source Heat Pump Industry Development in North and South America', and 'Application and Development of Japan's Latest Airsource Heat Pump Technology in Cold Area', respectively.

Source: JARN, July 25, 2013

Researchers Developing Low-Energy Personal Heating, Cooling System for Offices

Researchers from UC Berkeley's Center for the Built Environment (CBE) are using a \$1.6 million grant from the California Energy Commission to develop and promote a new set of tools to enable more efficient temperature control in buildings by using input from building occupants, a network of Web-based applications, and a user-responsive Personal Comfort System (PCS). The PCS uses low-wattage devices embedded into a system of chairs, foot warmers and fans that can quickly warm or cool individual users on demand. The system targets the most thermally sensitive parts of the body such as the face and head, the torso and feet, to provide warmth or cooling as needed and desired, rather than trying to maintain one temperature for an entire building or floor.

Source: <http://dailyfusion.net/2013/08> and

The HVAC&R Industry e-Newsletter No.35

Policy

Reviving U.S.-India cooperation on climate change

Secretary of State John Kerry visited to New Delhi, India, in June. The visit was a key opportunity for Secretary Kerry to reinvigorate U.S.-India cooperation on climate change and to continue to make progress under the Green Partnership, the landmark clean energy and climate change agreement forged by President Obama and Prime Minister Singh in 2009. Since the Green Partnership was signed, the United States and India have made significant progress in creating the foundation for cooperative research, development, and policy endeavours on climate change and clean energy. For example, both U.S. government agencies and businesses played a major role in growing India's solar energy market, which is now well over 1GW of installed solar energy.

Source: JARN, July 25, 2013

Energy Efficiency Standard for ATW heat pump to be enforced in China

The U.S. Department of Energy (DOE) has proposed new efficiency rules that would reduce expenses and emissions from commercial refrigerators and coolers. The requirements for equipment used in commercial applications such as restaurants, convenience stores and ice-cream shops will require decreased use of electricity to reduce costs and greenhouse-gas emissions. The two proposals, if unchanged when issued as final rules, would reduce electricity use by as much as 28 billion dollar and cut 350 million tons of carbon-dioxide emissions over the next 30 years, according to the White House.

Source: JARN, July 25, 2013



HFC tax could cost 1.2 billion Euro annually

A proposed tax on the sale of HFCs in Europe could cost companies and consumers up to €2 billion per year, according to refrigerant producers. Following the recent proposals by the European Parliament's environment committee for a CO₂ equivalent tax of up to €10/tonne, the European Fluorocarbon Technical Committee (EFCTC) warned of the negative impact that this would have on industry already struggling in a depressed market."

Source: <http://www.acr-news.com>

Heat pumps have vital role in emissions reduction targets

In a new report suggesting that the UK will fail to meet its carbon emissions target, the Government Committee on Climate Change has criticised the inadequate levels of investment in heat pumps, describing heat pumps as an important option for meeting carbon budgets.

According to the Committee on Climate Change, the UK is not currently on track to meet its third and fourth carbon budgets and suggests it will be necessary for the Government to develop and implement further policy measures over the next two years to meet its statutory commitments.

It calls on the government to extend the Renewable Heat Incentive to the residential sector and ensure funding beyond 2015. It also suggests allowing the Green Deal finance scheme to cover the up-front cost of purchasing heat pumps. Current incentives are described as weak.

Source: <http://www.acr-news.com>

New federal commercial refrigeration rules to reduce GHGs, costs

The U.S. Department of Energy (DOE) has proposed new efficiency rules that would reduce expenses and emissions from commercial refrigerators and coolers. The requirements for equipment used in commercial applications such as restaurants, convenience stores and ice-cream shops will require decreased use of electricity to reduce costs and greenhouse-gas emissions. The two proposals, if unchanged when issued as final rules, would reduce electricity use by as much as \$28 billion and cut 350 million tons of carbon-dioxide emissions over the next 30 years, according to the White House.

Source: <http://www.whitehouse.gov/blog/2013/08/29/>
and

<https://www.ashrae.org>

UK politicians call for maximum workplace temperature

As the UK basks in a heat wave, a group of UK politicians is calling for a maximum temperature of 30 °C in the workplace. The Labour Party's Linda Riordan has attracted the support of 27 other members of the Parliament for a motion to impose a maximum workplace temperature. A legal minimum workplace indoor temperature has been in place for many years but there is no legal maximum, so that in hot weather conditions can vary greatly from employer to employer.

Source: <http://www.acr-news.com>

Working fluids

Chunlan starts R290 production line reconstruction

Chunlan has entered an agreement with the Ministry of Environmental Protection and China Household Electrical Appliances Association, on the 'Technology Reform Project of Replacing R22 with Propane in the Production of Room Air Conditioner'. The plan is to set up an R290 air conditioner production line, with annual production volume nearing 1 million units.

Source: <http://www.ejarn.com>

US EPA warns against use of hydrocarbons in domestic air conditioning

The US Environmental Protection Agency (EPA) has warned against the illegal use of hydrocarbon refrigerants in domestic air conditioning systems.

The EPA warns that home air conditioning systems are not designed to handle propane or other similar flammable refrigerants. "The use of these substances poses a potential fire or explosion hazard for homeowners and service technicians," it says. The EPA is currently investigating instances where propane has been marketed and used as a substitute for R22.

Source: <http://www.acr-news.com>

Latest SAE tests say R1234yf risks are very small

The latest SAE cooperative research project (CRP1234) into the safety of R1234yf in car air conditioning systems has confirmed that the risks are still very small compared to the risks of a vehicle fire from all causes and well below risks that are commonly viewed as acceptable by the general

public.

The latest CRP was carried out in response to Daimler's tests last year which suggested that R1234yf posed a greater risk of vehicle fire than was estimated by the previous CRP1234 analysis.

The latest results are based on two new fault tree scenarios to consider the possibility of an individual being unable to exit the vehicle due to a collision or a non-collision event that involves a refrigerant/oil release, the refrigerant/oil being ignited and the fire propagating. The fault tree analysis is said to have examined average risks across the entire global fleet and used a number of conservative assumptions to ensure that the final risk estimate would be more likely to overestimate rather than underestimate actual risks.

Source: <http://www.acr-news.com>

DuPont calls on EU to crack down on MAC non-compliance

DuPont has called on the EU to aggressively curb noncompliance with the MAC Directive and called on the German motor industry to take an open, collaborative approach to testing cars designed to use HFO-1234yf. DuPont's statement follows this week's announcement that the EU is likely to support the French ban on certain Mercedes cars using the now banned R134a in their vehicle air conditioning systems.

"Allowing implicit noncompliance with the law would cripple the EU's future ability to enforce environmental requirements and also take away any sound basis to invest in future innovation," said Thierry F. J. Vanlancker, president, DuPont Chemicals & Fluoroproducts. "The European Union clearly recognizes this and has stated that efforts to circumvent the MAC Directive are unacceptable. The action by French authorities to block registration of certain vehicles underscores how seriously this is taken by Member States."

Source: <http://www.acr-news.com>

HFOs have lower GWPs than CO₂ - new report

The new HFO alternative refrigerants have been found to have GWPs below that of carbon dioxide, according to a new study.

An independent peer-reviewed paper published in the latest issue of *Reviews of Geophysics* found both R1234yf and R1234ze to have GWPs less than the baseline of 1 for CO₂ and substantially lower than previously thought. Until now, R1234yf had a published GWP of 4 and R1234ze a GWP of 6.

The paper, *Global warming potentials and radiative efficiencies of halocarbons and related compounds: A comprehensive review*, found the radiative efficiencies (RE) of 49 compounds to be significantly different from those in the published in the most recent Intergovernmental Panel on Climate Change Fourth Assessment Report (AR4). The report also presents new RE values for more than 100 gases which were not included in AR4.

The paper was produced by several leading chemists and environmental scientists from Europe and the US, is the first known study where the GWPs of all fluorocarbon-based refrigerants have been calculated consistently using all available atmospheric data, taking into account local atmospheric patterns.

Source: <http://www.acr-news.com>

Markets

World heat pump market forecast to grow 29 % by 2020

Fuji-Keizai, a general marketing research company, has published the results of its research on the world market for air conditioning equipment, residential water heaters, and other related equipment utilizing heat pump technologies.

The company cited markets for residential heat pump water heaters and multi-type air conditioners as noteworthy. It forecasts that the residential heat pump water heater market will expand to ¥196.6 billion (about US\$ 2 billion) in 2020, up 29 % over 2012.

In 2012, the world market dwindled to ¥152.2 billion (US\$ 1.5 billion), down 8 % from the previous year, as demand for residential heat pump water heaters remained sluggish in response to the slowdown in the housing markets of various countries. Nevertheless, the residential heat pump water heater market in China registered a small increase. Going forward from 2013, the market is forecast to expand mainly in China, Europe, and North America, reflecting the reinforcement of environmental regulations and implementation of incentives to introduce higher efficiency equipment.

The Japanese market is forecast to trace a downward path in the near future and then begin turning upward from 2016, mainly due to the expected expansion of replacement demand and decreases in running costs. However, it is thought that stabilization of electric power supply holds the key to fullscale market expansion.

Source: JARN, July 25, 2013



Ongoing Annexes

IEA HPP Annex 35 / IETS Annex 13 Application of Industrial Heat Pumps

The Annex 35 is a joint venture of the IEA Implementing Agreements "Industrial Energy-related Technologies and Systems" (IETS) and "Heat Pump Programme" (HPP), which now officially expires on 30 April 2014.

The work of the last year will be mainly concentrated on the **task 2** programme "Modeling calculation and economic models", in particular on updating and modernizing a database for industrial heat pumps, and the update and completion of the other annex reports as identified in the legal text:

- **Task 1:** Heat Pump Energy situation, energy use, market overview, barriers for application
- **Task 3:** R&D projects
- **Task 4:** Case studies

To ensure a uniform account of the individual contributions, a standardised factsheet has been prepared.

A major tool for **task 5** will be the annex homepage <http://www.ecleer.com/web/guest/industry/projects/iea> to communicate, and to make policy-makers, industrial planners and designers, stake holders as well as heat pump manufacturers aware about heat pumping technologies for industry. This will lead to a better understanding of the opportunities for the reduction of primary energy consumption, CO₂ emissions, as well as energy costs of industrial processes.

The second Annex meeting during 2013 will once again be organized in connection with the European Heat Pump Summit at the Exhibition Centre (Messezentrum) Nürnberg, Germany, 15 – 16 October 2013. More specifically on Monday, 14 October 2013, 13.00-17.00, Congress Center NCC Mitte.

Contact: Hans-Jürgen Laue
Information Centre on Heat Pumps and Refrigeration, IZW. e.V
laue.izw@t-online.de

IEA HPP Annex 36 Quality Installation / Quality Maintenance Sensitivity Studies

Annex 36 is evaluating how installation and/or maintenance deficiencies cause heat pumps to perform inefficiently (i.e., decreased efficiency and/or capacity). Also under investigation are the extent that operational deviations are significant, whether the deviations (when combined) have an additive effect on heat pump performance, and whether some deviations (among various country-specific equipment types and locations) have greater impact than others. The focus and work to be undertaken by each participating country is given in the table below.

Currently, Annex 36 participants are completing their efforts and are working towards providing draft country reports (with executive sum-

mary) to the Annex Operating Agent (OA) by early-September 2013. The OA will then assemble the country reports into a rough draft final Annex report and re-share with Annex participants by end-September 2013.

A working meeting is planned for 10 – 11 October 2013 at EDF's facilities just outside of Paris, France. The main purpose of the meeting will be to finalize the Annex report and secondarily to update planning for the final results workshop to be held at the upcoming 11th IEA Heat Pump Conference (Montreal, Quebec, Canada; 12 – 16 May 2014).

Contact: Glenn C. Hourahan,
Glenn.Hourahan@acca.org

Annex 36 Participants	Focus Area	Work to be Undertaken
France	Space heating and water heating applications.	Field: Customer feedback survey on heat pump system installations, maintenance, and after-sales service. Lab: Water heating performance tests on sensitivity parameters and analysis.
Sweden	Large heat pumps for multi-family and commercial buildings Geothermal heat pumps	Field: Literature review of operation and maintenance for larger heat pumps. Investigations and statistical analysis of 22000 heat pump failures. Modeling/Lab: Determination of failure modes and analysis of found failures and failure statistics.
United Kingdom	Home heating with ground-to-water, water-to-water, air-to-water, and air-to-air systems.	Field: Replace and monitor five geothermal heating systems Lab: Investigate the impact of thermostatic radiator valves on heat pump system performance.
United States (Operating Agent)	Air-to-air residential heat pumps installed in residential applications (cooling and heating).	Modeling: Examine previous work and laboratory tests to assess the impact of ranges of selected faults covered augmented by seasonal analyses modeling to include effects of different building types (slab vs. basement foundations, etc.) and climates in the assessment of various faults on heat pump performance. Lab: Cooling and heating tests with imposed faults to correlate performance to the modeling results.

Participating countries in Annex 36



IEA HPP Annex 38 Solar and heat pump systems

The objective of Annex 38 of the Heat Pump Programme, which is also Task 44 of the Solar Heating and Cooling Programme of the IEA, is the assessment of the performances and the relevance of combined systems using solar thermal collectors and heat pumps.

Task 44 investigates the main parameters that influence the performances of hybrid solar and heat pump systems. This work in progress shows that the following criteria should be carefully considered when designing a solar and heat pump system:

- Simplicity of hydraulics configuration
- Parallel configuration rather than more complex systems
- Serial configuration if control is optimally implemented
- Connection to the tank in proper locations
- Temperature sensors in the tank at the correct height
- Return temperatures to the tank

Other parameters can also have a large influence, especially if they are not adequately designed from the beginning (for example, flow rates or capacity of heat exchangers).

Task 44 will provide more insights into these parameters in all final reports that will be available at the beginning of 2014.

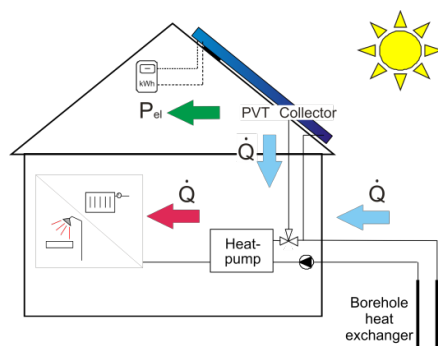

A PVT collector connected to a ground coupled heat pump for space heating and domestic hot water (doc SPF Switzerland)

A new trend on the market is to use PVT collectors in combination with a heat pump. PVT collectors are solar collectors that can provide both heat and electricity (see figure). This allows a potential net zero annual consumption for a solar and heat pump system. However, more optimization is needed to achieve cost effective solutions.

All reports can be found on:
<http://task44.iea-shc.org/>

Contact: Jean-Christophe Hadorn,
jchadorn@baseconsultants.com

IEA HPP Annex 39 A Common Method for Testing and Rating of Residential HP and AC Annual / Seasonal Performance

In the Annex 39 project, the fourth work meeting was held in conjunction with the EHPA General Assembly in Brussels, May 14. Results from the participating partners were presented and discussed. Important facts about the real performance of heat pumps in part load operation were introduced, which could affect the annual performance metric. Attempts have been made to develop a methodology that gives maximum information on operational characteristics with a minimum number of test points.

Annex 39 plans to arrange a workshop in Berlin at the end of November, together with CEN TC228-WG4, to discuss and propose implementation of the SEPOMO methodology, as well as other related issues regarding standardization.

Annex 39 will have its fifth working meeting in conjunction with the HPP ExCo meeting in Tokyo on November 12.

Contact: Roger Nordman,
roger.nordman@sp.se

IEA HPP Annex 40 Heat pump concepts for Nearly Zero Energy Buildings

IEA HPP Annex 40 is to investigate and improve heat pump concepts applied in Nearly or Net Zero Energy Buildings (nZEB). The Annex 40 started work in the beginning of 2013. The working time of the Annex 40 is scheduled for three years, 2013 - 2015. Currently, the six countries CH, JP, NL, NO, SE and the USA are participating in the Annex 40.

The Annex 40 has been structured in 4 Tasks. Task 1 on the state-of-the-art in the participating countries will be finished by the end of August 2013. Many nZEB are currently built in the central European countries Germany, Austria and Switzerland, as well as in North-America. Norway has several nZEB in the planning phase. In Canada, a field test of so-called Equilibrium houses has been performed.

Political strategies in Europe, North America and Japan strongly focus on the target of nZEB by 2020 or 2030, but no common definition of nZEB exists, yet. The common understanding of the nZEB is a grid-connected building which produces as much energy as it consumes by renewable

energies on-site on an annual basis. In 2013, a definition by REHVA has been published in line with the CEN standardisation, so more conformity between the different national definitions in the European countries is expected in the future.

The dominating technology to reach an nZEB is currently the combination of PV and heat pump. In Switzerland, PV is installed in nearly all of the more than 200 nZEB certified according to the MINERGIE-A®-label, while heat pumps make-up a fraction of more than 80 %. Further technologies used are wood boilers and solar thermal collectors. Collectors are mainly used for DHW production. The MINERGIE-A® label is currently restricted to residential buildings.

The next Annex 40 working meeting is scheduled for October 2013 at TNO in the Netherlands, in order to discuss interim results on Task 2 on system analysis and optimisation, and Task 3 on technology developments and field experience, as well as to prepare a workshop at the IEA Heat Pump Conference 2014 in Montréal.

Contact: Carsten Wemhöner,
carsten.wemhoener@hsr.ch

IEA HPP Annex 41 Cold Climate Heat Pumps

Heat pump technology provides a significant potential for CO₂ emissions reduction. Annex 41 will revisit research and development work in different countries to examine technology improvements leading to successful heat pump experience in cold regions. The primary focus is on electrically driven air-source heat pumps (ASHP) with air (air-to-air HP) or hydronic (air-to-water HP) heating systems, since these products suffer severe loss of heating capacity and efficiency at lower outdoor temperatures. Thermally activated (engine-driven, absorption, etc.) ASHPs and ground-source heat pumps (GSHP) may also be included in individual country contributions, if desired. The main technical objective is to identify solutions leading to ASHPs with heating SPF ≥ 2.63 W/W, recognized as a renewable technology. The main outcome of this Annex is expected to be information-sharing on viable means to improve ASHP performance under cold ($\leq -7^{\circ}\text{C}$) ambient temperatures.

During the past quarter the 1st working meeting was held at Purdue University on July 1-2. Among the highlights to report is the fact that Austria announced just after the meeting its intention to become an official Participant in the Annex joining Japan and the US. At the meeting the Japanese and U. S. teams provided a number of presentations describing technical progress and plans for the Annex work. Additionally, the Japanese submitted a draft Task 1 report (literature/technology review). The U. S. Task 1 report draft is planned to be submitted in September/October. A common characteristic to note about all the various system configurations being investigated (analytically and experimentally) by the Annex Participants is the added complexity required in order to achieve significant improvement in low ambient temperature heating capacity (and efficiency) for an ASHP. Additional compressor capacity or novel com-

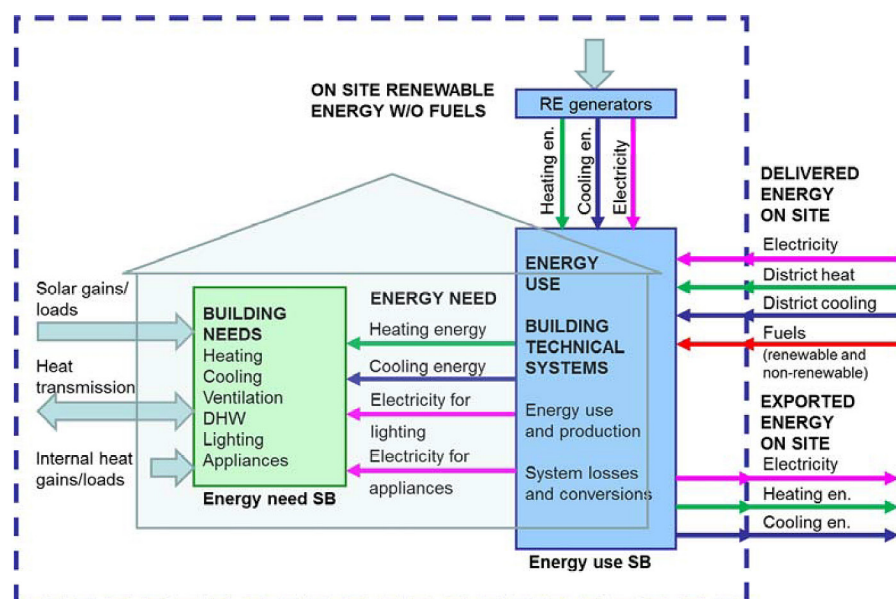

Boundary of nZEB in REHVA definition (Source: J. Kurnitski, REHVA Journal, May 2013)

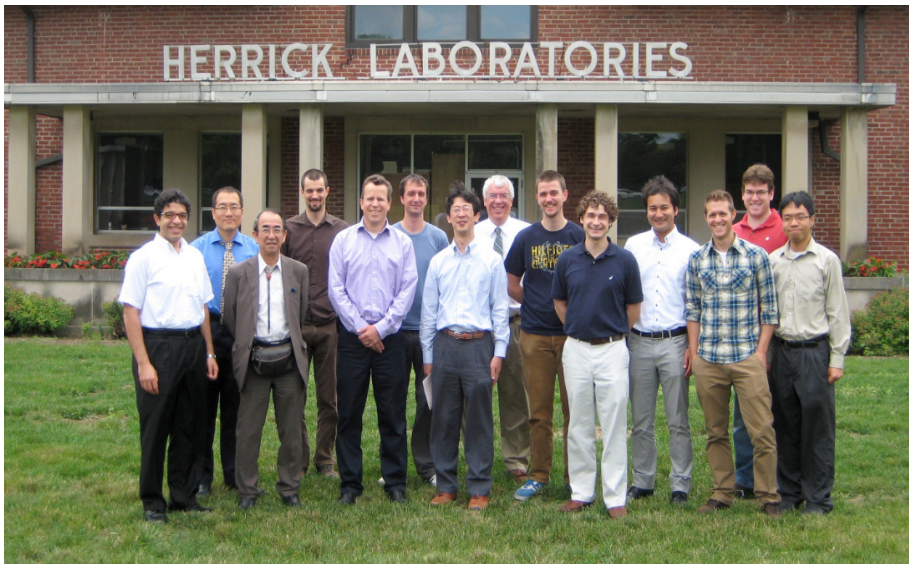

Annex 41 July 1-2, 2013 Purdue meeting attendees

pressor approaches, cycle enhancements (ejectors or vapor injection), or incorporation of supplemental renewable energy sources will be necessary. These capacity and efficiency enhancement measures will lead to more complex (and costly) systems compared to standard single-compressor ASHPs. After the meeting a web site was established <http://web.ornl.gov/sci/ees/etsd/btrc/usnt/QiQ-mAnnex/indexAnnex41.shtml>. All of the presentations and reports from the meeting are posted to the site along with the minutes and agenda.

After the close of the working meeting the Participants were treated to several technical tours. Professors Eckhard Groll and Travis Horton hosted a visit to the Ray Herrick Laboratories at Purdue on July 1. On July 2, Professors Tony Jacobi and Pega Hrnjak hosted visits to the Air Conditioning and Refrigeration Center at the University of Illinois and to the offices and laboratories of Creative Thermal Solutions, Inc. both in Urbana, IL.

The next planned meetings of the Annex are a web meeting (February/March 2014) and the 2nd working meeting and workshop to be held at the 11th IEA Heat Pump Conference in Montreal. The Annex officially began in July 2012 and is expected to run through September 2015.

We still welcome additional Participants until December 31, 2013.

Contact: Van D. Baxter,
baxtervd@ornl.gov

IEA HPP Annex 42 Heat Pumps in Smart Grids

After discussing this item as a potential subject for an Annex in fall 2011, the Legal Text was further developed in close cooperation between the IEA Heat Pump Centre in Sweden and the undersigned during summer 2012. Initial presentations at the HPP Symposium in Nurnberg in October 2012 about, at that time, the 'Proposed Annex' were received very well by delegates of the member states within the HPP.

During the National Teams' meeting, the member states gave their input for further detailing and elaboration of the Legal Text. The conclusion at the end of this meeting was that more or less 'a full house' of member states intended to join and support the Annex. At the ExCo meeting in November in London, a final presentation and brief discussion of the proposed Annex led to a clear positive vote by the ExCo delegates. Commitment to the Annex 42 was expressed by, amongst others, Sweden, USA, Korea, Finland, Germany, The Netherlands, and Austria. Several other member states consider participating in this Annex 42 in due course as well. Due to the upcoming new year, with the new budgets, this might take somewhat more time.

Status of activities:

- Template notification letters have been sent to the member states in which they can officially confirm their participation to the IEA office in Paris, HPP and the Operating Agent.
- The first version of a planning scheme is being drafted.
- An online project management tool in ActiveCollab is equipped to enable all participants from all over the world to cooperate within one single online project management environment.
- The first meeting of the Annex 42 project group is foreseen in May 2013 (Parallel to EHPA General Assembly in Brussels).

Contact: Peter Wagener, Business Development Holland,
wagener@bdho.nl

IEA HPP Annex 43 Fuel-driven sorption heat pumps

During the work in Annex 34 “Thermally Driven Heat Pumps for Heating and Cooling”, there was a rising interest in the area of fuel driven sorption heat pumps, and more and more products came close to market. Since we learned during the process of Annex 34 that the fields of solar thermal cooling and fuel driven heat pumping need different measures for a wider market penetration, there was a common understanding to continue this work in two different annexes or tasks. Therefore the work of annex 34 regarding solar thermal cooling is continued within the the IEA implementing agreement Solar Heating and Cooling, as Task 48 “Quality assurance and support measures for Solar Cooling”, while for the continuation of the fuel driven heat pumps part a new annex “Fuel driven sorption heat pumps” was proposed to the HPP ExCo in March 2012. After an annex definition meeting, a legal text was compiled and as draft accepted by the ExCo, so the annex 43 started officially in July 2013, with a duration of 4 years. A kick-off meeting will take place on 9-10 October 2013 in Freiburg, Germany, with participants from at least 5 countries to finalise the work plan.

The scope of the work under this Annex will be on the use of fuel driven sorption heat pumps in domestic and small commercial or industrial buildings, or applications. If applicable, the additional possibility of supplying cold will also be considered. The main goal is to widen the use of fuel driven heat pumps by accelerating technical development and the way to market as well as to identify market barriers and supporting measures. Conducting field tests, as well as proposing performance evaluation figures and optimal system layouts, are among the means of this annex.

The tasks are further specified as follows:

Task A Generic Systems and System Classification

- Available sources and heating systems
- Existing market and regulatory boundary conditions
- Control strategies
- Evaluate different fuels (oil, gas, wood -> no hot water)

Task B Technology Transfer

- Link research to industrial development for faster market penetration of new technologies
- Novel materials (e.g. MOFs for adsorption heat pumps)
- Novel components (integrated evaporators/condensers, compact heat exchangers)
- System designs (e.g. façade collector as a heat source)

Task C Field test and performance evaluation

- Measurement/monitoring procedures standardisation (e.g. how to cope with different fuel qualities, system boundaries, auxiliary energy etc.)
- Continue work from Annex 34 and Task 44, and extend standards to seasonal performance factors at system level
- Develop quality insurance procedures in cooperation with IEA-SHC Task 48

Task D Market potential study and technology roadmap

- Simulation study to evaluate different technologies in different climate zones, different building types and different building standards
- Combine with market data and actual building stock for technology roadmap

Task E Policy measures and recommendations, information

- Dissemination
- Workshops for planners, installers and decision makers
- Technology road show
- Develop recommendations for policies, e.g. building codes and funding schemes

So far, several countries have expressed interest in joining, but of course more participants are welcome.

Germany, UK and Italy are confirmed. France, Austria and the Netherlands as well as the USA have shown strong interest so far.

Contact: Peter Schossig, Fraunhofer ISE,
peter.schossig@ise.fraunhofer.de

IEA HPP Annex 44 Performance indicators for energy efficient supermarket buildings

At the Executive Committee Meeting of the Implementing Agreement on Heat Pumping technologies (HPP) of May 28 and 29, 2013 in Oslo, approval was given to the Annex proposal “Performance indicators for energy efficient supermarket buildings” under Annex number 44. The legal text for the Annex has been finalised and submitted for electronic approval. At the moment Sweden and The Netherlands have agreed to participate. Interested countries are invited to contact the Operating Agent, Mr S.M. van der Sluis (see contact information).

Energy consumption data for individual stores of supermarket chains are often available, through own measurements or from utility bills. But these data only become meaningful when put in the right context of sales area, outdoor temperatures, etc. Only then can the actual energetic performance of individual stores be assessed. A method to do this will be developed in this Annex, with an emphasis on practical use rather than academic perfection.

A kick-off meeting for Annex 44 was held in June 2013 in Stockholm, with participants from Sweden and The Netherlands. At this meeting the scope, the outlines of the methodology, and the tasks to be performed have been discussed. At the meet-



Swedish participants at the Annex 44 kick-off meeting: Jaime Arias (KTH), Ulla Lindberg (SP) and Per Lundqvist (KTH)

ing it was agreed that each of the research partners (SP, KTH, Saint Trofee and Consultancy) will set up contacts with one or more super-market organizations to cooperate throughout the project, not only to provide relevant input to the project, but also to ensure that the results will be practical and applicable by super-market organizations.

Contact: Sietze van der Sluis,
s.m.vandersluis@gmail.com

Ongoing Annexes

Bold text indicates Operating Agent. ** Participant of IEA IETS or IEA SHC

Annex 35 Application of Industrial Heat Pumps (together with Task XIII of "Industrial Energy-Related Technologies and Systems" (IEA IETS))	35	AT, CA, DE , DK, FR, JP, KR, NL, SE
Annex 36 Quality Installation/Quality Maintenance Sensitivity Studies	36	FR, SE, UK, US
Annex 37 Demonstration of Field measurements of Heat Pump Systems in Buildings – Good examples with modern technology	37	CH, SE , UK
Annex 38 Solar and Heat Pump Systems	38	AT**, BE**, CA**, CH , DE, DK**, ES**, FI, FR**, IT**, UK
Annex 39 A Common Method for Testing and Rating of Residential HP and AC Annual/Seasonal Performance	39	AT, CH, DE, FI, FR, JP, KR, NL, SE , US
Annex 40 Heat Pump Concepts for Nearly Zero-Energy Buildings	40	CH , FR, JP, NL, NO, US
Annex 41 Cold Climate Heat Pumps (Improving Low Ambient Temperature Performance of Air-Source Heat Pumps)	41	JP, US
Annex 42 Heat Pump in Smart Grids	42	DE, FI, KR, NL , US
Annex 43 Fuel Driven Sorption Heat Pumps	43	DE , UK
Annex 44 Performance Indicators for Energy Efficient Supermarket Buildings	44	NL , SE

IEA Heat Pump Programme participating countries: Austria (AT), Canada (CA), Denmark (DK), Finland (FI), France (FR), Germany (DE), Italy (IT), Japan (JP), the Netherlands (NL), Norway (NO), South Korea (KR), Sweden (SE), Switzerland (CH), the United Kingdom (UK), and the United States (US). All countries are members of the IEA Heat Pump Centre (HPC). Sweden is the host country for the Heat Pump Centre.

Refrigerant Charge in Heat Pumps – Part I – Charge Inventory Analysis and the advent of charge reduction

T. Oltersdorf, S. Braungardt, C. Sommer, Germany

This article, the first of two, gives an overview on past and current activities to analyse and reduce refrigerant charge in heat pumps. It focusses on the increasing awareness on effects of charge variations and how charge reduction activities have started. In the second half of the article a short survey on commonly applied experimental techniques to investigate charge inventory and a review on some current activities for charge distribution are presented. Part 2 is planned for the next issue of the HPC Newsletter.

Motivation for investigating charge minimization

Since the phase down of ozone-depleting HCFC refrigerants, in most applications they have been replaced by HFCs. Current HFCs are not considered a final solution because of their high global warming potential. All available alternatives to traditional HFCs present some disadvantages, i.e. toxicity (ammonia), flammability (hydrocarbons, HFOs, ammonia), high cost in refrigerant (HFOs) or system (CO₂).

One straightforward possibility to reduce the impact of the disadvantages of all refrigerants is to design heat pumps and refrigerating systems with less refrigerant charge

Review on charge inventory analysis and reduction activities

Proper refrigerant charge

Poggi et al. [1] and Vaitkus [2] stated that formerly a common practice for a proper charge was to fill the evaporator 50 % with liquid refrigerant. One of the first compilations of common charging methods and their comparison was published by Houcek and Thedford [3]. However, a widely accepted charging technique is using a sight glasses ahead of the expansion device. The needed charge is achieved when there are no bubbles visible. Recently Corberan [4] reviewed existing charge

variation studies and recommended maximum evaporation and condensation temperatures and minimum compressor speed to find the proper charge.

Impact of charge variations

According to Rice [5] charge reduction for existing systems is beneficial for:

1. the cycling performance,
2. the recovery rates from defrost cycle reversal as well as
3. improved compressor reliability.

While charge reduction the compressor reliability should always augment when the charge is reduced due to the decreasing probability of liquid slugging, the first two aspects will only improve up to a certain point with charge reduction.

Experimental activities to investigate the correlation between charge and efficiency to the author's knowledge are mentioned at first by Farzad and O'Neal [6] as in-house investigations of the company Trane in 1976 [7]. However, publically known activities started with the work of Domingoarena [8] in 1978.

Theoretical and publically available studies started much earlier according to Rice [5], who provides a rough review on activities from the 1960s. Excellent and more recent reviews on experimental and modeling efforts are given in Poggi et al. [1], Corberán et al. [9] and Vaitkus [2].

Growing awareness of charge reduction

The above mentioned activities were more related to the determination of the optimal charge and did not intend to investigate measures to decrease the charge. Explicit research on charge reduction was started for heat exchangers. According to the review of Heun and Dunn [10] this was initiated by efforts of the Modine Manufacturing Company for system charge reduction for mobile air conditioning systems by application of brazed aluminium heat exchangers, especially condensers. Comparing the timelines, this research was already driven by the phase-out for CFCs [11]. Due to the need of compact refrigeration and quick innovation cycles and very large lot sizes the application for mobile systems was much earlier than for stationary systems. According to Chapp [12] again Modine initiated a debate on charge reduction in stationary systems by a study focusing on the exchange of A-coil (fin-and-tube) with bent microchannel heat exchangers. Until recently the high piece prices due to small lot sizes are one of the main barriers why these heat exchangers do not replace conventional fin-and-tube heat exchangers. By investigating various heat exchanger manufacturer portfolios a change for this trend can be noticed at least for the condenser. Nevertheless this replacement is challenging due to the progress in tube diameter decrease in conventional heat exchangers [13]. Also for larger systems charge reduction became more relevant in recent

years to investigate alternatives to flooded shell-and-tube heat exchangers. Gonzalez et al. [14] has provided an exhausting and excellent survey on falling-film evaporators. Cavallini et al. [15] achieved a reduction of 65 % of the inner volume in a condenser compared to a plate heat exchanger.

Excellent and more recent reviews on experimental and modeling efforts are given in Poggi et al. [1], Corberán et al. [9] and Vaitkus [2].

Techniques for charge inventory analysis

Experimental investigation of refrigerant mass distribution in the cycle

The knowledge of the charge amount and its distribution in the components of a heat pump allows a better understanding of the influence of refrigerant charge on the performance and the optimization of refrigerant charge. Therefore many measurement methods were developed and investigated. In general the methods can be separated in static and dynamic measurements. There are several methods, which are presented below:

»Online mass measurement

Online mass measurement is possible when the component e.g. an evaporator can be mounted on a balance. After installation the balance is tared and measures the actual refrigerant mass.

»Quick closing valve techniques

The refrigerant cycle is equipped with quick closing valves to trap the refrigerant in the specific part of the cycle being investigated. Then during operation the valves are closed and the refrigerant content of the separated component is determined. Several procedures for determination of the mass were developed and its state of the art is well described in Ding et al. [16]. One possibility is to fully liquefy the refrigerant into a receiver cooled with liquid nitrogen and then weigh the captured refrigerant in the receiver. This can also

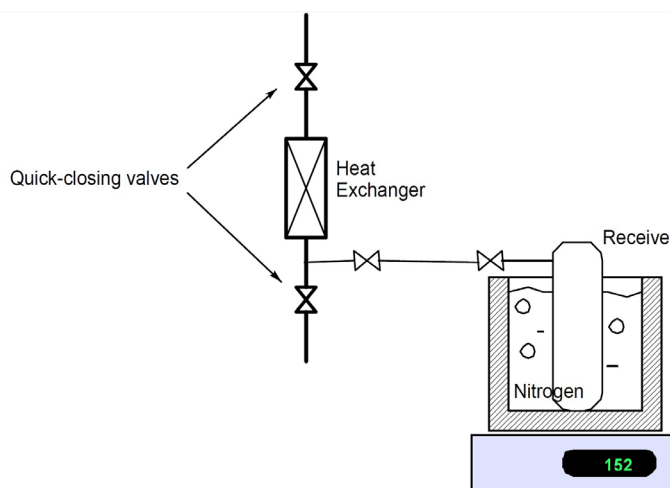

Figure 1. Quick closing valve technique and weighing [17]

be done in a quasi-online procedure when the receiver stays connected to the cycle with a flexible tube. Instead of weighing the receiver it is also possible to quantify the mass by determining the liquid level, pressure and temperature.

Another possibility is to connect the sampled component to a large evacuated tank. Then one has to wait for getting thermodynamic equilibrium at superheat conditions in the tank and measure the pressure. Finally the mass can be calculated when the density and the tank-volume are known [16, 18].

»Mass measurement in compressor

The described techniques can be used for heat exchangers, pipes, receivers or accumulators, but for the compressor some more steps are necessary. Part of the refrigerant mass in the compressor is available directly as gas, but the major part is dissolved in the compressor oil. In order to determine the total amount of refrigerant in the compressor two approaches can be used. One possibility is the extraction of oil and refrigerant and slow separation by connection to an ice bathed receiver while heating and stirring the refrigerant-oil mixture. Then the amount of refrigerant in the receiver can be determined by one of the above described techniques.

The other possibility is to mount a sight tube to the compressor and then extract the refrigerant from the compressor to a cooled receiver but

always watching the oil-level and avoiding oil been drawn out. This can be avoided by an outlet in the upper part; when it is opened, the refrigerant oil mixture starts boiling and the level rises. Before reaching the outlet the valve must be closed [16]. For easy understanding imagine opening a bottle of Coke that has been shaken and avoid the liquid coming out.

»Theoretical calculation of the refrigerant mass distribution

To estimate the refrigerant charge, the knowledge of vapour and that of liquid present at any location in the refrigerant system is necessary. For all components with single phase flow the volume has to be known and its mass can be calculated knowing its density. But condenser, receiver, feeder lines and evaporator have two-phase flows or at least are operated with two-phase states of the refrigerant. The flow velocities of the gas phase and of the liquid phase usually are not the same; therefore knowledge of the vapour quality in the system is not sufficient for the estimation of the refrigerant mass but the void fraction (averaged volumetric fraction of gas) has to be known. Many correlations for the void fraction have been developed, most of them for nuclear reactor cooling or for gas and oil piping. As a consequence, some correlations present only limited accuracy for two-phase refrigerant. Beyond others, the corre-

Author	Cooling Capacity	System design	Compressor	Expansion Device	Evaporator	Condenser	Receiver / Accumulator / Filter	Refrigerant	Charge	Test conditions	
										Evap. [°C]	Cond. [°C]
	[kW]	Type [-]							[kg]		
Ding [16]	7.1	A/C	n.a. ^{a)}	n.a. ^{a)}	Fin-and-Tube	Fin-and-Tube	Yes	R410a	2	27	35
Corberan [25]	16	W/W HP	Scroll	TEV	BPHE	BPHE	No	R290	0.55	10	33
Jin [26]	4	Mobile A/C	Piston	Orifice tube	Plate-and-fin	Micro-channel	Yes	R134a	0.95	3	46.3
				TEV							
Bjork [27]	0.12	Refrigerator	Piston	Capillary tube	Wire on tube	Roll-bond flat plate	Yes	R600a	0.033	-10	50
Palm [28]	5	W/W HP	Scroll	TEV	BPHE	BPHE	No	R290	0.25	6	40
Hoehne [29]	1.5	Refrigeration ^{b)}	Piston	Manual valve	Micro-channel	Micro-channel	Yes	R290	0.13	11	41

a) Values were based on a DC spark in the horizontal position of the parallel plates
 b) Measured in micro-gravity environment

Table 1. Survey on system specification for studies dealing with charge distribution

lations by Zivi [19], Premoli [20] and Baroczy [21] are reported to give accurate results [5, 22, 23]. For microchannels, the surface forces have higher influence compared to larger hydraulic diameters, therefore different correlations are being investigated [24].

Charge Distribution

The charge distribution is dependent on many parameters like component and system design, refrigerant and operating conditions. Table 1 and Figure 2 comprise a non-exhaustive survey on former investigations, their system configurations and the component-wise charge distribution.

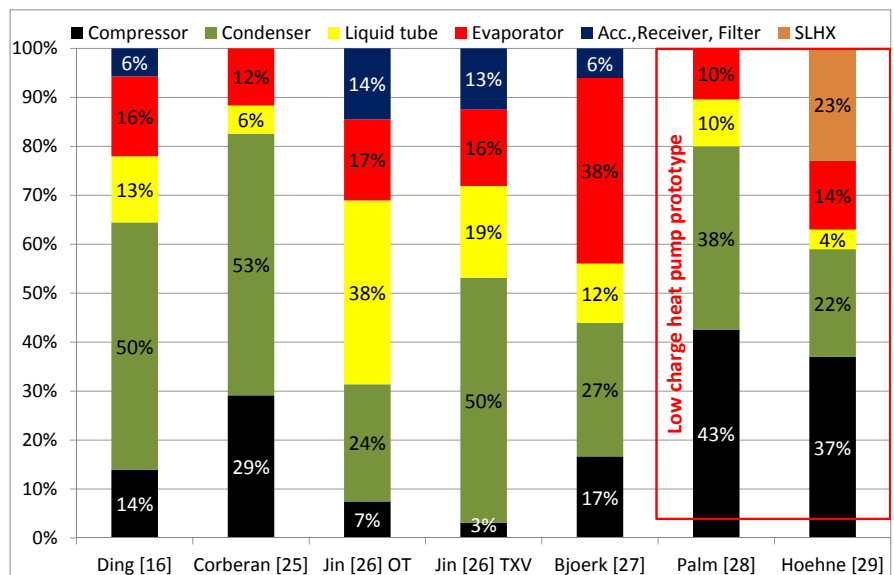

Figure 2. Overview of the charge distribution in various systems

Whereas Figure 2 shows that usually most of the refrigerant is collected in the condenser, a significant share is located in the liquid line. Even the typically used receiver holds a capacity of up to 15 %. The two low charge systems on the very right side

of the figure show a significant reduction of the refrigerant mass in the heat exchangers while the refrigerant mass dissolved in the compressor oil gains influence.

Implication of charge reduction to energy efficiency of a system

In this chapter, the influence of the amount of charge on a given refrigerant cycle is analysed. In a system without receiver or accumulator, any excess refrigerant is located in the outlet of the condenser. This means, that additional refrigerant leads to higher subcooling in the condenser. In principle, higher subcooling is positive for the system COP. But at the same time, the heat exchanger area available for condensation shrinks, when a larger part of the condenser is blocked by liquid refrigerant. So, in order to transfer the same amount of heat, the condensation pressure rises. This effect is negative for the COP. These two opposing effects lead to a certain amount of charge where the COP is at its maximum.

Figure 3 reveals, that at low refrigerant charge, additional charging leads to a considerable increase in subcooling while condensing pressure is hardly affected, while at high refrigerant charge, additional charging increases the condensation pressure with only little effect on subcooling [25].

When no subcooling is achieved due to massive undercharging, COP and capacity of the system decrease rapidly. This is probably caused by occurrence of bubbles at the inlet of the expansion valve [25].

In Figure 4, an overview of several systems is given to show the behaviour of the COP depending on the charge level. It illustrates the relative change in COP by varying the charge level for four machines without a liquid receiver. In all cases, a clear maximum in COP can be appreciated but the sensitivity to charge variation is very different in the studied systems.

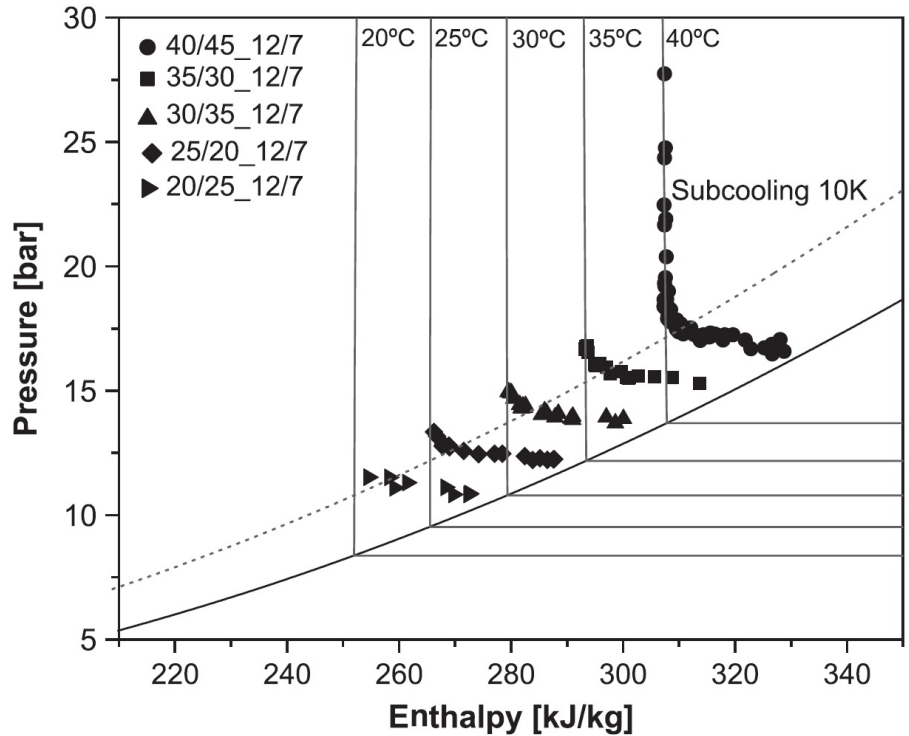

Figure 3. Detail of the condenser outlet conditions in the subcooling area for several charges at five different water temperatures [8]

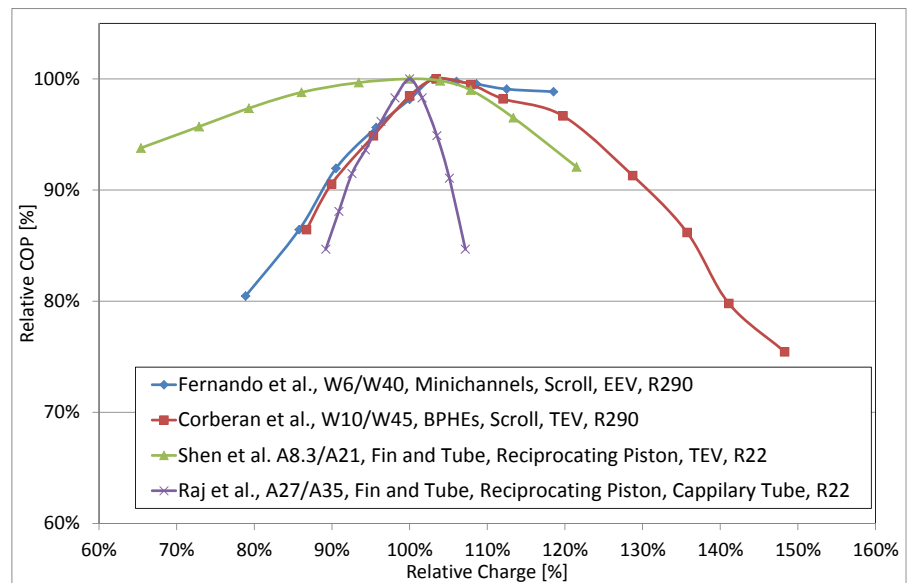

Figure 4. Relative COP changes depending on the variation of the nominal refrigerant charge in the studies of Fernando et al. [30], Corberán et al. [25], Shen et al. [31] and Raj and Lal [32].

In general it can be stated that fixed throttling devices are more sensitive to efficiency losses due to charge variations.

Final remarks

A short overview on investigation activities concerning charge inventory analysis and charge reduction has been given in the first part. Then, methods of charge analysis and typical charge distribution in different heat pump and refrigeration systems have been presented. This first part of a small review of refrigerant charge in heat pumps closes with a presentation of the sensitivity of the system efficiency on charge variations.

Author contact information

Dipl.-Ing. Thore Oltersdorf,
Fraunhofer-Institute for Solar Energy
Systems ISE, Heidenhofstrasse 2,
79110 Freiburg, Germany
thore.oltersdorf@ise.fraunhofer.de

Dipl.-Ing. Simon Braungardt,
Fraunhofer-Institute for Solar Energy
Systems ISE, Heidenhofstrasse 2,
79110 Freiburg, Germany

Dipl.-Ing. Christian Sonner,
Fraunhofer-Institute for Solar Energy
Systems ISE, Heidenhofstrasse 2,
79110 Freiburg, Germany

References

- [1] Poggi, F., et al., *Refrigerant charge in refrigerating systems and strategies of charge reduction*. International Journal of Refrigeration, 2008. 31(3): p. 353-370.
- [2] Vaitkus, L., *Low Charge Transport Refrigerator (I). Refrigerant Charge and Strategies of Charge Reduction*. Mechanika, 2012. 17(6).
- [3] Houcek, J. and M. Thedford. *A Research Into a New Method of Refrigeration Charging and the Effects of Improper Charging*. in Proceedings of the First Symposium on Improving Building Systems in Hot and Humid Climates. 1984.
- [4] Corberán, J.M., *Refrigerant Charge Optimization, in IIR Workshop on Refrigerant Charge Reduction*, IIR, Editor 2012, IIR: Valencia.
- [5] Rice, C.K., *The effect of void fraction correlation and heat flux assumption on refrigerant charge inventory predictions*. ASHRAE Transactions, 1987. 93(Part 1): p. 341-367.
- [6] Farzad, M. and D. O'Neal, *An evaluation of improper refrigerant charge on the performance of a split system air conditioner with capillary tube expansion*. Texas A&M University, Energy Systems Laboratory Report ESL-TR-88/07-01. July, 1988.
- [7] Trane, *Cooling Performance Testing on a Common Eight Year Old Residential Air Conditioning Unit*, May 24, 1976: LaCross, WI.
- [8] Domingorena, A.A., *Performance evaluation of a low-first-cost, three-ton, air-to-air heat pump in the heating mode*. NASA STI/Recon Technical Report N, 1978. 80: p. 16551.
- [9] Corberán, J.-M., et al., *Influence of the source and sink temperatures on the optimal refrigerant charge of a water-to-water heat pump*. International Journal of Refrigeration, 2011. 34(4): p. 881-892.
- [10] Heun, M. and W. Dunn, *Performance and Optimization of Micro-channel Condensers*, University of Illinois, 1995, ACRC TR-81.
- [11] Bullard, C.W. and R. Radermacher, *New technologies for air conditioning and refrigeration*. Annual review of energy and the environment, 1994. 19(1): p. 113-152.
- [12] Chapp, T., M. Voss, and C. Stephens. *Waking the Sleeping Giant: Introducing New Heat Exchanger Technology into the Residential Air-Conditioning Marketplace*. in Proceedings of 10th ACEEE Summer Study on Energy Efficiency in Buildings. 1998.
- [13] Filippini, S. and M.U. *New finned heat exchanger development with low refrigerant charge*. in Proceedings of 23rd IIR International Congress on Refrigeration. 2011.
- [14] Gonzalez Garcia, J., J. Saiz Jabardo, and W. Stoecker, *Falling film ammonia evaporators, 1992*, ACRC Technical Report, TR-33, University of Illinois, Urbana.
- [15] Cavallini, A., E. Da Riva, and D. Del Col, *Performance of a large capacity propane heat pump with low charge heat exchangers*. International Journal of Refrigeration, 2010. 33(2): p. 242-250.
- [16] Ding, G., et al., *Practical methods for measuring refrigerant mass distribution inside refrigeration system*. International Journal of Refrigeration, 2009. 32(2): p. 327-334.
- [17] Leducq, D. *Refrigerant mass measurement and typical charge distribution*. in 3rd Workshop on Refrigerant Charge Reduction in Refrigerating Systems. 2012. Valencia, Spain.
- [18] Björk, E., *A simple technique for refrigerant mass measurement*. Applied Thermal Engineering, 2005. 25(8-9): p. 1115-1125.
- [19] Zivi, S., *Estimation of steady-state steam void-fraction by means of the principle of minimum entropy production*. Journal of Heat Transfer, 1964. 86: p. 247.
- [20] Premoli, A., D. DiFrancesco, and A. Prina, *A dimensionless correlation for the determination of the density of two-phase mixtures*. Termodinamica, (Milan), 1971. 25(1): p. 17-26.

- [21] Baroczy, C., *A systematic correlation for two-phase pressure drop*, 1966, Atomics International, Canoga Park, Calif.
- [22] Harms, T.M., E.A. Groll, and J.E. Braun, *Accurate charge inventory modeling for unitary air conditioners*. *Hvac&R Research*, 2003. 9(1): p. 55-78.
- [23] Da Riva, E., D. Del Col, and A. Cavallini. *Modeling of performance and charge in minichannel heat exchangers*. in *IIR 2th Workshop on Refrigerant Charge Reduction*, KTH, Stockholm, Sweden. 2010.
- [24] Winkler, J., et al., *Void fractions for condensing refrigerant flow in small channels: Part I literature review*. *International Journal of Refrigeration*, 2012. 35(2): p. 219-245.
- [25] Corberán, J.M., I.O. Martínez, and J. González, *Charge optimization study of a reversible water-to-water propane heat pump*. *International Journal of Refrigeration*, 2008. 31(4): p. 716-726.
- [26] Jin, S., *Distribution of Refrigerant in Automotive Air Conditioning Systems*, in *Mechanical Engineering 2012*, University of Illinois at Urbana-Champaign: Urbana-Champaign.
- [27] Björk, E. and B. Palm, *Performance of a domestic refrigerator under influence of varied expansion device capacity, refrigerant charge and ambient temperature*. *International Journal of Refrigeration*, 2006. 29(5): p. 789-798.
- [28] Palm, B.E., *Summarizing a Decade of Experience on Charge Reduction for Small Hydrocarbon, Ammonia and HFC Systems*, in *Proc. 1st IIR Workshop on Refrigerant Charge Reduction in Refrigerating Systems 2009*, Academic Conferences Publishing: Paris, France. April 6-7, 2009.
- [29] Hoehne, M.R. and P. Hrnjak *Charge Minimization in Systems and Components Using Hydrocarbons as a Refrigerant*. *Air Conditioning and Refrigeration Center*, 2004.
- [30] Fernando, P., et al., *Propane heat pump with low refrigerant charge: design and laboratory tests*. *International Journal of Refrigeration*, 2004. 27(7): p. 761-773.
- [31] Bo Shen, J.E.B., Eckhard A. Groll, *The Impact of Refrigerant Charge, Airflow, and Expansion Devices on the Measured Performance of an Air-Source Heat Pump—Part I*. *ASHRAE Transactions*, 2011. 117 Part 2.
- [32] LAL, M.H.R.a.D.M., *An Experimental Analysis of the Effect of Refrigerant Charge Level and Outdoor Condition on a Window Air Conditioner*. *Thermal Science*, 2010. 14(4): p. 1121 - 1138.

A Tool for Life Cycle Climate Performance (LCCP) Based Design of Residential Air Source Heat Pumps

Mohamed Beshr¹, Vikrant Aute¹, Omar Abdelaziz²
Brian Fricke², Reinhard Radermacher¹

¹Department of Mechanical Engineering, University of Maryland College Park, USA

²Oak Ridge National Laboratory, USA

A new tool for evaluation of the Life Cycle Climate Performance (LCCP) of air source heat pumps (ASHP) is presented. This is the first tool which allows for the design of ASHP systems based on their LCCP. The annual energy consumption of the ASHP, required for the calculation of the indirect emissions, is determined either from AHRI Standard 210/240 or from any system simulation software. The tool supports three different ASHP types: single speed, two capacity, and variable speed. The underlying LCCP calculation framework is open source and can be easily customized for various applications. The flexibility of this tool allows for its use with any system simulation tool, load model, and different emission and weather databases.

Introduction

The Kyoto protocol [1] has placed restrictions on greenhouse gas (GHG) emissions including high GWP refrigerants commonly used in vapor compression systems servicing HVAC&R needs. One method to reduce the negative environmental impact of such systems is to design them with environmental impact as one of the primary performance criteria. Several metrics have been proposed and used in public literature for quantification of this environmental impact.

The system's Life Cycle Climate Performance (LCCP) was presented as a comprehensive metric in the 1999 report of the Montreal Protocol Technology and Economic Assessment Panel (TEAP) [2]. The aim of LCCP analysis is to calculate the equivalent mass of carbon dioxide (CO₂) released into the atmosphere due to the operation of a system, throughout its lifetime, from construction to operation and destruction.

The CO₂ emissions from a vapor compression system are divided into direct and indirect emissions. Direct emissions comprise leakage of refrigerant occurring during system operation, servicing, and at the end of life as well as during refrigerant production and transportation. Indirect emissions consist of the environmental effect of the production and distribution of the energy required to operate the vapor compression

system in addition to the energy associated with the production and transportation of the different system components.

The LCCP methodology can be used to compare the environmental performance of different refrigerants and technologies in applications such as automobile air conditioning, residential and commercial refrigeration, unitary air conditioning, and HVAC chillers [3]. Papasavva et al. [4-7] developed a comprehensive life cycle analysis tool limited to mobile air conditioners (GREEN-MAC LCCP). Additional LCCP analysis has recently been performed for various refrigeration and air conditioning systems [8-13]. The LCCP tool presented in [13] focused on residential air source heat pumps (ASHP). However, this tool cannot be extended to other systems and it

can only be used for evaluating the LCCP of an existing ASHP system rather than designing the system based on LCCP.

This paper presents a new extensible framework for LCCP-based design and analysis of refrigeration and air-conditioning systems.

LCCP Framework

Our proposed LCCP tool methodology is shown in Fig. 1 [14]. This framework relies on four main modules: (1) the core open-source LCCP calculation methodology, (2) the system performance model, (3) the load model, and (4) standardized reference data sets for emissions and weather. These modules interact with each other via standardized communication interfaces that describe the data input-output process.

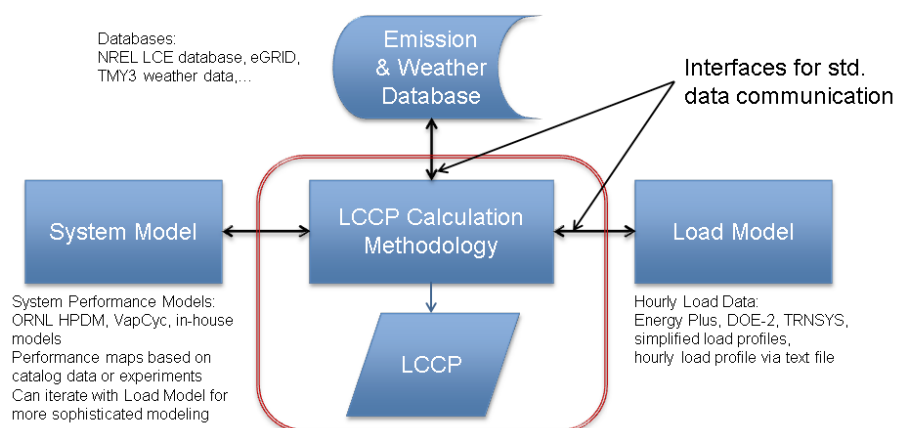

Figure 1. LCCP Tool Framework [23].

Because of the modular nature, any individual module can be replaced with a user-supplied module. This makes the framework highly extensible and suitable for analyzing a variety of systems.

The load model is used to determine the hourly load values which are required by the system performance model. In turn, the system performance model, using the weather data, calculates the hourly energy consumption of the system. The hourly consumption is then multiplied by the hourly emission rate for electricity production, obtained from the standardized reference datasets for location-specific emissions, to obtain the hourly emission due to the energy consumption of system. The default values for the hourly emission rate for specified locations within the USA are obtained from Deru et al. [15]. Some building energy modeling tools such EnergyPlus [16] can be used to determine both the hourly load and energy consumption, in which case, separate system performance and load models are not required.

The default weather data available in the LCCP tool are based on the Typical Meteorological Year (TMY) data from the National Solar Radiation Data Base [17]. These datasets include dry-bulb temperature, dew-point temperature, and relative humidity for all 8760 hours of the year. The tool has 47 built-in cities with the ability of adding additional user defined cities.

The default GWP values used in the LCCP tool are obtained from the IPCC Fourth Assessment Report (AR4) [18] and are based on the 100 year time horizon (GWP100). The GWP values of other refrigerants which are not listed in AR4 were obtained from AHRTI [13], based on values provided by manufacturers, or compiled from publicly available information. The tool has 13 refrigerants with the ability of adding more user defined refrigerants.

$$Em_{direct} = Em_{ref,leak} + Em_{acc} + Em_{serv} + Em_{ref,EOL} + Em_{ref,prod} + Em_{reaction} \quad Eq. (1)$$

$$Em_{ref,leak} = Charge * System\ lifetime * Annual\ leak\ rate * GWP \quad Eq. (2)$$

$$Em_{acc} = Charge * System\ lifetime * Annual\ accident\ leak\ rate * GWP \quad Eq. (3)$$

$$Em_{serv} = Total\ number\ of\ services * Charge * Servicing\ leak\ rate * GWP \quad Eq. (4)$$

$$Em_{ref,EOL} = Percent\ of\ refrigerant\ lost\ at\ end\ of\ life * Charge * GWP \quad Eq. (5)$$

$$Em_{ref,prod} = Ref\ production\ \&\ transportation\ leak\ rate * Charge * GWP \quad Eq. (6)$$

$$Em_{indirect} = Em_{sys,man} + Em_{ref,man} + Em_{sys,EOL} + Em_{ref,disp} + Em_{elec} + Em_{sys,trans} \quad Eq. (7)$$

$$Em_{sys,man} = Mass\ of\ each\ material * CO_2\ equivalent \quad Eq. (8)$$

$$Em_{ref,man} = Charge * (1 + System\ lifetime * Annual\ leak\ rate - Percent\ of\ reused\ refrigerant) * CO_2\ equivalent\ emissions\ for\ virgin\ refrigerant \quad Eq. (9)$$

$$Em_{sys,EOL} = Energy\ of\ recycling\ of\ metals * Mass\ of\ metals * CO_2\ equivalent\ of\ metals + Energy\ of\ recycling\ of\ plastics * Mass\ of\ plastics * CO_2\ equivalent\ of\ plastics \quad Eq. (10)$$

$$Em_{sys,elec} = System\ lifetime * \sum_{n=0}^{8760} Hourly\ energy\ consumed * Emission\ rate\ for\ location \quad Eq. (11)$$

$$Total\ emissions = Total\ direct\ emissions + Total\ indirect\ emissions \quad Eq. (12)$$

Emission Calculations

Direct Emissions

The six contributors to the direct emissions may be combined to yield the total direct emissions, Em_{direct}' as shown in Eq. (1-6) where $Em_{ref,leak}$ are due to refrigerant leakage, Em_{acc} are due to accidents, Em_{serv} are due to servicing, $Em_{ref,EOL}$ are due to refrigerant leakage at end-of-life, $Em_{ref,prod}$ are due to refrigerant production and transportation, $Em_{reaction}$ is the reaction byproduct of the atmospheric breakdown of the refrigerant emissions.

Indirect Emissions

The total indirect emissions, $Em_{indirect}'$ can be calculated as shown

in Eq. (7-11). There are six contributors to the indirect emissions: emissions due to energy required to manufacture the system, $Em_{sys,man}'$ emissions due to energy used to manufacture the refrigerant, $Em_{ref,man}'$ emissions due to energy required to recycle the system, $Em_{sys,EOL}'$ emissions due to refrigerant recycling and disposal at end-of-life, $Em_{ref,disp}'$ lifetime emissions due to electric energy consumption, Em_{elec}' and emissions due to energy used to transport the system, $Em_{sys,trans}'$.

Total Emissions

Finally, the total emission, representing the LCCP analysis and including the contributions from direct and indirect emissions, is calculated as shown in Eq. (12).



Case Study – System Description

As previously mentioned, this LCCP tool can be used either as an evaluation tool or as a design tool. If the tool is being used for the evaluation of an ASHP, the AHRI Standard 210/240 [19] is used to calculate the hourly energy consumption of the system. In this case, we select the system type (single speed, two-capacity, or variable speed compressor), (heat pump, or cooling only), and the backup heat type. As for the load model, AHRI Standard 210/240 [19] provides guidance on the hourly load values based on the weather data. A more sophisticated approach would be to use a load model such EnergyPlus.

Using the tool for the design of an ASHP system requires coupling system simulation software to the tool. In this case we can either couple the LCCP tool to an hourly load model or to static hourly load data provided by a separate model. We then perform parametric and sensitivity analyses to understand the impact of the design configuration on LCCP. It is worth noting that a web version is available for the ASHP with both the evaluation and design capabilities [20].

An ASHP system with inputs similar to the default single speed system in the AHRI ASHP LCCP tool [13] was investigated. The system is located in Chicago, IL and is operating with R410A as the refrigerant with a system charge of 4.54 kg. The system inputs are displayed in Fig. 2. The AHRI standard is used for hourly load and energy consumption calculations.

Results and discussions

A snapshot of LCCP evaluation for the system described above operating in Chicago, IL is presented in Fig. 3. Fig. 3 shows a life cycle emissions of 134 MTons of CO₂ equivalent emission largely driven by indirect emissions (93.63 %). While operating the system in different cities

Test45235 Type	Capacity [Btu/hr]	Power [W]
Cooling, A Test, Indoor (80F/67F), Outdoor (95F/75F)	40704	3444
Cooling, A Test, Indoor (80F/67F), Outdoor (82F/65F)	45100	2931
Heating, H1 Test, Indoor (70F/-), Outdoor (47F/43F)	38600	3353
Heating, H2 Test, Indoor (70F/60F), Outdoor (35F/33F)	30912	3233
Heating, H3 Test, Indoor (70F/60F), Outdoor (17F/15F)	22199	3064

Figure 2. ASHP system inputs.

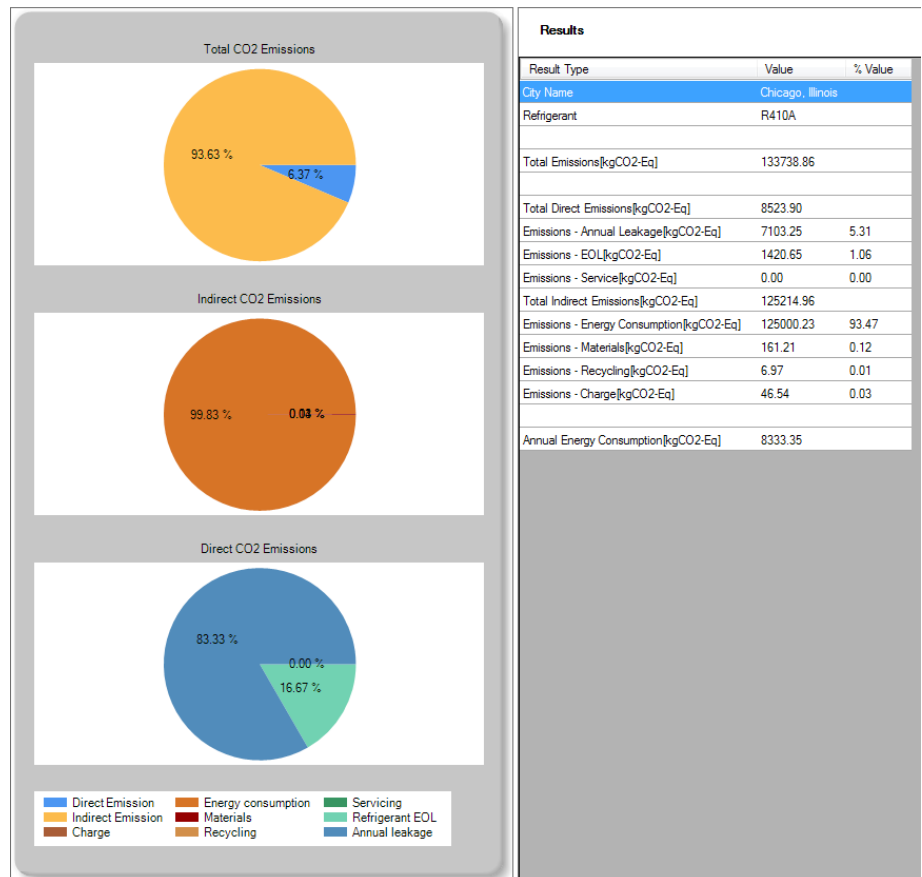

Figure 3. System LCCP evaluation results.

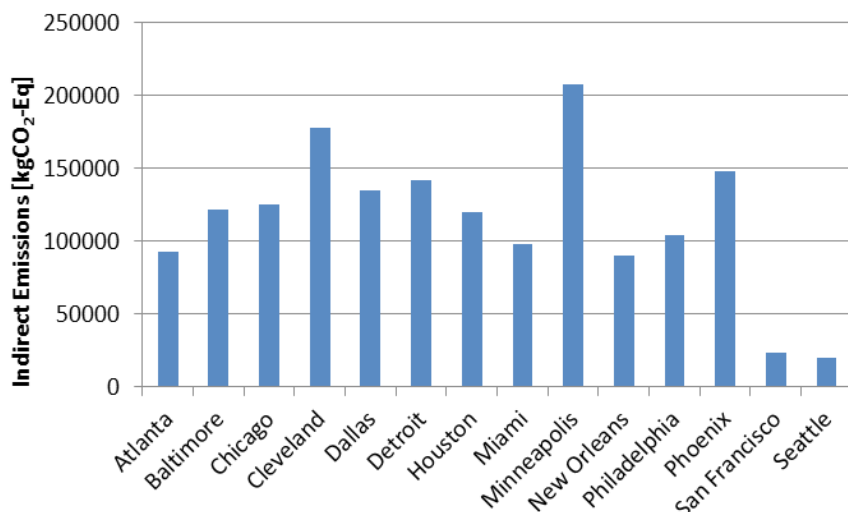

Figure 4. System indirect emissions for different cities.

does not affect the direct emissions, it affects the indirect emissions due to differences in local emissions and weather data. As such, the impact of system location is studied as shown in Fig. 4.

It is worth noting that the low indirect emissions in San Francisco and Seattle are due to two main reasons. The first is that these two cities have mild climates and thus the heat pump will operate for shorter periods as compared to other cities. For instance, by comparing the annual energy consumption in Seattle and Chicago (which has a more extreme climate), it is found that the consumption in Chicago is almost two times that in Seattle. The second reason is that the hourly emission rate for electricity production in these two cities is low compared to other cities. For example, the emission rate in Chicago is about 3.5 times that in Seattle.

Also, as a result of the low indirect emissions in Seattle, the direct emissions represent around 30 % of the total emissions rather than 6 % for Chicago. This shows that for cities such as Seattle, direct emissions, especially due to the annual leakage of the refrigerant, would require more focus due to their higher impact on the total emissions than in other cities.

Conclusion

A new tool for LCCP evaluation of vapor compression systems which can be used to design HVAC&R systems for optimal LCCP is presented. The framework implemented in the tool is flexible and allows for the evaluation of different systems and load models. A sample ASHP system case is analyzed using the tool. The results of this study show that for a heat pump system operating in Chicago, IL, the indirect emissions present 93.63 % of the lifecycle CO₂ equivalent emissions – largely due to energy consumption. The impact of location on load and emissions factors was also studied showing the impact of local weather and hourly electricity emission rates on the LCCP. This suggests that when designing and operating a heat pump for the northeastern US market, there will be a different focus (i.e., leak tightness during manufacturing and installation) than when designing it for a marine market (e.g. San Francisco and Seattle).

Author contact information

Dr. Reinhard Radermacher
 Department of Mechanical Engineering,
 University of Maryland College Park,
 MD 20742, USA
 raderm@umd.edu

Mohamed Beshr
 Department of Mechanical Engineering,
 University of Maryland College Park,
 MD 20742, USA

Vikrant Aute
 Department of Mechanical Engineering,
 University of Maryland College Park,
 MD 20742, USA

Omar Abdelaziz
 Oak Ridge National Laboratory,
 Bethel Valley Rd, Oak Ridge,
 TN 37831, USA

Brian Fricke
 Oak Ridge National Laboratory,
 Bethel Valley Rd, Oak Ridge,
 TN 37831, USA

Acknowledgments

This work was supported in part by the Oak Ridge National Laboratory (ORNL) and the Integrated Systems Optimization Consortium (ISOC) at the University of Maryland. The authors also acknowledge the support of Building Technologies Office of the US Department of Energy for their financial support and Honeywell International Inc. for their in-kind and technical support.

Supporting Information Available

This LCCP tool is available free of charge via the internet at: <http://lccp.umd.edu/ornlccp/>

References

- [1] United Nations, 1998. *Kyoto Protocol to the United Nations Framework Convention on Climate Change*.
- [2] UNEP/TEAP report, 1999. *The Implications to the Montreal Protocol of the Inclusion of HFCs and PFCs in the Kyoto Protocol*.
- [3] Arthur D. Little, Inc., 1999. *Global Comparative Analysis of HFC and Alternative Technologies for Refrigeration, Air Conditioning, Foam, Solvent, Aerosol Propellant, and Fire Protection Applications*. First published in 1999, and updated in 2002.
- [4] Hill, W., Papasavva, S., 2005. *Life Cycle Analysis Framework; a Comparison of HFC-134a, HFC-134a Enhanced, HFC-152a, R744, R744 Enhanced, and R290 Automotive Refrigerant Systems*. SAE Technical Series Paper, 2005-01-1511, Society of Automotive Engineers, Warrendale, PA.
- [5] Papasavva, S., Hill, W., 2005. *A Comparison of R134a, R134a Enhanced, R152a, R744 and R290 Automotive Refrigerant Systems Based on Life Cycle*. Presentation at the Workshop on Technology Cooperation for Next-Generation MAC, NewDelhi, India.
- [6] Papasavva, S., Hill, W., Major, G. A., 2004. *Comparison of R134a, R134a Enhanced, R152a, R744 and R290 Automotive Refrigerant Systems Based on Life Cycle*. Presentation at MAC Summit, Washington DC.
- [7] Papasavva, S., Hill, W., and Andersen, S.O., 2010. *GREEN-MAC-LCCP: A Tool for Assessing the Life Cycle Climate Performance of MAC Systems*. Environmental Science and Technology, Volume 44, Issue 19, Pages 7666-7672.
- [8] Hwang, Y., Jin, D.-H., and Radermacher, R., 2007. *Comparison of R-290 and two HFC blends for walk-in refrigeration systems*. International Journal of Refrigeration, Volume 30, Issue 4, Pages 633-641.
- [9] Spatz, M.W., Motta, S.F.Y., 2004. *An evaluation of options for replacing HCFC-22 in medium temperature refrigeration systems*. International Journal of Refrigeration, Volume 27, Issue 5, Pages 475-483.
- [10] Johnson, R.W., 2004. *The effect of blowing agent choice on energy use and global warming impact of a refrigerator*. International Journal of Refrigeration, Volume 27, Issue 7, Pages 794-799.
- [11] Abdelaziz, O., Fricke, B., and Vineyard, E., 2012. *Development of Low Global Warming Potential Refrigerant Solutions for Commercial Refrigeration Systems using a Life Cycle Climate Performance Design Tool*. Presented at the 14th International Refrigeration and Air Conditioning Conference, Purdue University, West Lafayette, Indiana.
- [12] Fricke, Brian A., Abdelaziz, O., and Vineyard, E., 2013. *Reducing the Carbon Footprint of Commercial Refrigeration Systems Using Life Cycle Climate Performance Analysis: From System Design to Refrigerant Operations*. Presented at the 2nd IIR International Conference on Sustainability and the Cold Chain, Paris, France.
- [13] Zhang, M., Muehlbauer, J., 2011. *Life Cycle Climate Performance Model for Residential Heat Pump System*. AHRTI Report No. 09003-01.
- [14] Oak Ridge National Laboratory (ORNL), and the University of Maryland College Park (UMCP), 2013. *LCCP Desktop Application v1 Engineering Reference*.
- [15] Deru, M., and Torcellini, P., 2007. *Source Energy and Emission Factors for Energy Use in Buildings*. NREL Technical Report NREL/TP-550-38617. National Renewable Energy Laboratory: Golden, CO.
- [16] US DOE. *EnergyPlus Energy Simulation Software*. Available at: <http://apps1.eere.energy.gov/buildings/energyplus/>
- [17] NREL, 2012. *National Solar Radiation Data Base, 1991-2005 Update: Typical Meteorological Year 3*. Renewable Resource Data Center, National Renewable Energy Laboratory: Golden, CO. Available at: http://rredc.nrel.gov/solar/old_data/nsrdb/19912005/tmy3/by_state_and_city.html
- [18] IPCC, 2007. *Fourth Assessment Report: Climate Change*. Geneva, Switzerland.
- [19] ANSI/AHRI, 2008. *ANSI/AHRI 210/240-2008 with Addenda 1 and 2, Performance Rating of Unitary Air-Conditioning & Air-Source Heat Pump Equipment*.
- [20] <http://lccp.umd.edu/ornllccp/>

Risk assessment study of mildly flammable refrigerants

Eiji Hihara, Japan

The Ministry of Economy, Trade and Industry of Japan (METI) and the New Energy and Industrial Technology Development Organization of Japan (NEDO) have been subsidizing research to obtain basic information on mildly flammable refrigerants, since 2011. In addition, a research committee was set up by the Japan Society of Refrigerating and Air Conditioning Engineers to assess the risks associated with mildly flammable refrigerants. The Japan Refrigerating and Air Conditioning Industry Association and the Japan Automobile Manufacturers Association are presently conducting definitive risk assessments, and the results are being discussed by the research committee. This report is a brief introduction to the 2012 progress report [1].

Introduction

The use of chlorofluorocarbons (CFCs) and hydrochlorofluorocarbons (HCFCs) has been widely restricted. They have been replaced with hydrofluorocarbons (HFCs) in order to protect the ozone layer. However, the leakage of refrigerant into air from active or end-of-life air conditioners has been a serious environmental issue owing to the high global warming potential (GWP). It has therefore been widely recognized that the replacement of HFCs with low-GWP refrigerants is a reasonable solution of the problem. The number of room, package, and mobile air conditioners shipped from Japan in 2011 was 8.20 million, 7.78 million, and 4.73 million, respectively. These are the major types of air conditioning equipment produced in Japan. For the case of mobile air conditioners, there is a high possibility that the conventional refrigerant will be replaced with R1234yf. On the other hand, over the last several years, studies have been conducted on the use of lower-GWP refrigerants in stationary air conditioners.

To prevent global warming, regulations have been imposed regarding the use of high-GWP refrigerants such as the HFCs used in air conditioning equipment.

Need for research on the safety of mildly flammable refrigerants

The development of environmentally friendly refrigerants for room and package air conditioners is imperative to the growth of air conditioning technology. The low-GWP refrigerants R1234yf and R32 are promising candidates for conventional HFC refrigerants. In Japan, R32 is currently considered as a kind of low-GWP refrigerant. These refrigerants are not very stable in air and are sometimes flammable. It is therefore essential to collect basic data about the flammability of low-GWP refrigerants and to research the safety of their practical use. The integration of basic information about their physical properties, cycle performance, life cycle climate performance (LCCP), flammability, and risk assessment will

simplify selection and their practical use. These efforts are expected to contribute to the development of the global air conditioning industry.

R1234yf and R32 are less flammable than propane and R152 and are therefore referred to as mildly flammable refrigerants. In ASHRAE Standard 34, class 2L was recently set up for mildly flammable refrigerants with heat of combustion lower than 19 MJ/kg and burning velocities not faster than 10 cm/s. Together with ammonia, R1234yf and R32 are classified as 2L. The characteristics of the flammable refrigerants are listed in Table 1, where LFL, UFL, BV, and MIE respectively denote lower flammability limit, upper flammability limit, burning velocity, and minimum ignition energy. Compared to propane, which is highly flammable, 2L refrigerants have low BVs and high MIEs.

Refrigerant	GWP	LFL [vol%]	UFL [vol%]	BV [cm/s]	MIE [mJ]
R290 (Propane)	<3	1.8	9.5	38.7	0.246
R717 (Ammonia)	<1	15	28	7.2	21
R32	675	13.3	29.3	6.7	15
R1234yf	4	6.2	12.3	1.5	500

Table 1. Burning characteristics of flammable refrigerants

As shown in Fig. 1, all of the following conditions must be satisfied by a flammable refrigerant that leaks from an appliance near an ignition source:

1. Refrigerant concentration must be within the range of the flammability.
2. The energy of the ignition source must be higher than the MIE.
3. The air velocity adjacent to the ignition source must be lower than the BV in laminar flow conditions.

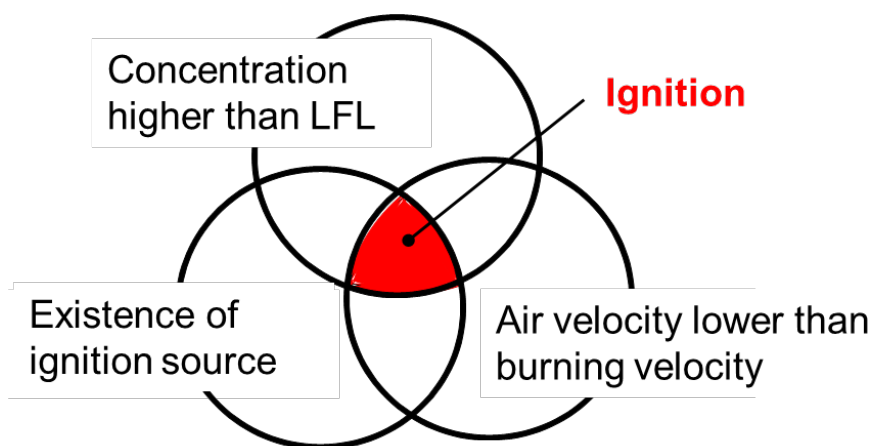

If the air velocity adjacent to the ignition source is higher than the BV in laminar flow conditions, burning will not occur because fire cannot be propagated against airflow.

Class 2L of ASHRAE Standard 34 has changed the restriction on refrigerants with regards to flammability. In Japan, however, only “non-flammable” and “flammable” classifications are recognized in the High Pressure Gas Safety Act and the Ordinance on Safety of Refrigeration. With the objective of gathering essential data for the risk assessment of mildly flammable refrigerants, safety studies are being conducted by project teams from the Tokyo University of Science at Suwa, Kyusyu University, University of Tokyo, and National Institute of Advanced Industrial Science and Technology (AIST). The studies have been sponsored since 2011 by the project on the “Technology Development of High-efficiency Non-fluorinated Air Conditioning Systems” of the New Energy and Industrial Technology Development Organization (NEDO).

In addition, a research committee was set up by the Japan Society of Refrigerating and Air Conditioning Engineers to assess the risks associated with mildly flammable refrigerants. The Japan Refrigerating and Air Conditioning Industry Association (JRAIA) and the Japan Automobile Manufacturers Association (JAMA),

Figure 1. Mechanism of ignition

are presently undertaking definite risk assessments, and the results are being discussed by the research committee.

Ignition and quenching of refrigerants [2]

The flammability limits are widely used, and a test method to measure flammability limits of 2L refrigerants has been established. For minimum ignition energy E_{min} , however, no appropriate test methods are ideally applicable to 2L refrigerants. The difficulty in determining a reliable E_{min} lies in the fact that E_{min} is highly dependent on the electrode geometry and the ignition spark density and

duration. On the other hand, several theoretical equations correlate E_{min} with the burning velocity (S_u) and quenching distance (d_q). Compared to measuring E_{min} , measuring d_q is much easier and provides reliable data on 2L refrigerants. Therefore, the correlation between S_u and d_q was experimentally obtained.

Table 2 lists the measured burning velocities and quenching distances of ten refrigerants. For R1234yf, the flame propagation velocity is so low that the effect of buoyancy on the quenching distance measurement is very large. Therefore, the quenching distance of R1234yf was measured in a microgravity environment.

Name	$S_{u0,max}$ [cm/s]	ρ_0 [kg/m ³]	$d_q^{a)}$ [mm]
R290	38.7	1.21	1.705
R152a	23.6	1.32	2.33
R1243zf	14.1	1.40	3.33
HFC143	13.1	1.45	3.58
R152a/134a (50/50 vol%)	11.7	1.45	4.08
HFC254fb	9.5	1.49	4.83
R717	7.2	1.08	7.85
R143a	7.1	1.46	6.51
R32	6.7	1.38	7.35
R1234yf	1.5	1.53	22.5 ^{b)}

a) Values were based on a DC spark in the horizontal position of the parallel plates
b) Measured in micro-gravity environment

Table 2. Quenching distances of 10 compounds

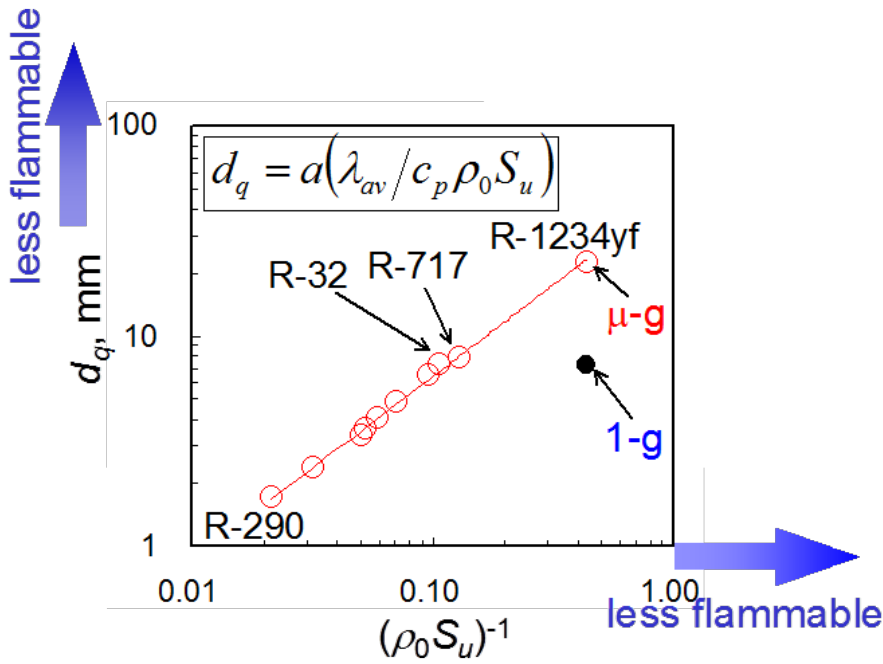

Figure 2. d_q vs. $1/\rho_0 S_{u0,max}$

Therefore, d_q is plotted against $1/\rho_0 S_{u0,max}$ in Fig. 2 with their regression curve. The exponentially fit curve represents the results for all of the compounds. The regression curve is given by $d_q = 47.61(\rho_0 S_{u0,max})^{0.871}$. Minimum ignition energies can be calculated with the theoretical correlation with $d_q = 47.61(\rho_0 S_{u0,max})^{0.871}$; selected results are listed in Table 1.

Physical hazard evaluation [3]

Here, several conceivable accident scenarios are considered, and experiments were performed. One accident scenario is a case where an air conditioner containing a 2L-class refrigerant is simultaneously used with a fossil-fuel heating system in a typical living space. In this scenario, we examined the ignition and flame propagation properties, as well as the generation behavior of the combustion products (HF: hydrogen fluoride).

R1234yf and R32 were used as the test 2L refrigerants, and the non-flammable refrigerant R410A was used as a reference. The amount of leaking refrigerant was 800 g, based on the amount installed in a typical room air conditioner on the market.

The target leakage rates were set as 10 g/min and 60 g/min. The size of the experimental room was 2.8 m × 2.8 m × 2.8 m. A room air conditioner was installed in a wall, with the center of the ventilation outlet 700 mm below the ceiling and at a horizontal distance of 1400 mm away from the corner of the experiment room. A Ø6.35 mm hole was made in the front panel of the air conditioner, and a refrigerant supply tube was inserted in this hole, which allowed refrigerant to leak through the ventilation outlet.

Figure 3 shows the HF concentration for each refrigerant. HF was produced at about 50–1500 ppm,

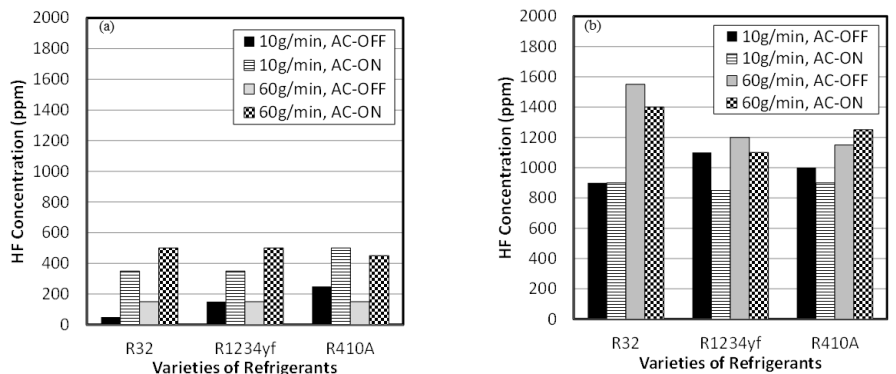

Figure 3. Comparison of HF concentration with leakage rate and operation of air conditioning system: (a) using a radiation stove and (b) using a fan heater

which is much greater than the permissible value designated by the Japan Society for Occupational Health. The amount of HF produced in the case with an oil fan heater was more than that produced with a radiative stove. This is because the refrigerant that was sucked into the fan heater burned completely, whereas in the case with the radiative oil fan heater, a portion of the refrigerant in contact with the heated body might have only been decomposed, instead of burned. In addition, although the HF generation of R32 was slightly greater than that of R1234yf and R410A, the HF generation from the 2L refrigerants was similar to R410A.

Time variation of leaked refrigerant concentration in a room [4]

It is important to understand the refrigerant diffusion phenomena when preparing the risk assessment. It is also necessary to clarify the effects of parameters on the diffusion phenomena of refrigerants heavier than air. Numerical analysis is an effective tool because it is difficult to measure the diffusion of a refrigerant in a large space. In this study, diffusion phenomena were numerically analyzed when a refrigerant leaked into a large space such as a living room or an office.

The size of the space where the refrigerant leaks into from a wall-mounted indoor unit was assumed to be

2.8 m × 2.5 m × 2.4 m. The indoor unit was located 1.8 m above the floor, at the center of one of the walls. The size of the indoor unit was 0.6 m × 0.24 m × 0.3 m, and the indoor unit had an air outlet with a size of 0.6 m × 0.06 m. The refrigerant leaked from this air outlet.

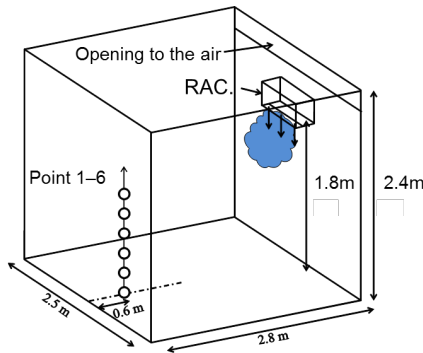

Figure 4. Indoor space, including wall-mounted indoor unit.

Figure 4 shows the geometry of the calculation field for the wall-mounted indoor unit. Table 3 lists the leakage scenarios and results of the calculation for the RAC. $\Sigma(V \times t)$ expresses integrated products of the flammable gas volume and presence time. This value is involved in the risk assessment and is called the flammable volume time (FVT). In addition, VFL represents the flammable

No.	Position of leakage	Refrigerant	Amount [g]	Flow rate [g/min]	Presence time [min]	$\Sigma(V_{FL} \times t)$ [$m^3 \times min$]	$\Sigma(V_{BVFL} \times t)$ [$m^3 \times min$]
1	Wall-mounted indoor unit	R32	1000	250	4.01	1.18×10^{-2}	0
2	ditto	R1234yf	1400	350	4.01	1.23×10^{-2}	0
3	ditto	R32	1000	125	8.01	9.79×10^{-3}	0
4	ditto	R1234yf	1400	175	8.01	1.07×10^{-2}	0
5	ditto	R32	1000	1000	1.03	3.73×10^{-2}	0
6	ditto	R1234yf	1400	1400	1.05	4.34×10^{-2}	0
7	ditto	R290	500	125	1473	7689	7688
8	ditto	R290	200	50	4.73	0.258	0.161

Table 3. Leakage scenarios and results for RAC

mable gas volume, whereas VBFL is the flammable gas volume with air velocity lower than the burning velocity.

Generally speaking, a combustible gas region only exists just below the air outlet of the indoor unit, even if all of the refrigerant is discharged. According to Table 3, the FVT is very small. In addition, from No. 1 to No. 6, the FVT values that consider the burning velocity are equal to 0. This indicates that ignition does not oc-

cur even if an ignition source exists, because of the convection caused by the refrigerant leakage. For propane (No. 7 and No. 8), the FVT represents a great hazard

Conclusion

Figure 5 shows the current schedule of the research committee. Based on the risk assessment, a new guideline of mildly flammable refrigerants for small refrigerating equipment will be drafted in FY2013. New safety

	FY2011	FY2012	FY2013	FY2014
University of Tokyo	Leakage of refrigerant into a room/ Production of HF			
AIST, Research Institute for Innovation in Sustainable Chemistry	Influence of humidity on flammability			
Tokyo University of Science, Suwa	Minimum ignition energy/ Quenching distance			
AIST, Research Institute of Science for Safety and Sustainability	Physical hazard evaluation and experiments			
Kyushu University	Safety analysis at explosion			
	Development of new low-GWP refrigerants			
Risk assessment by JRAIA	Mini-sprit risk assessment			
	VRF risk assessment			
	Chiller risk assessment			
Milestone	Progress report	Kobe symposium	Progress report	New legislation

Figure 5. Schedule of the research committee

rules and regulations are expected to come into effect by the end of FY2014. A progress report will be issued at the end of the fiscal year. This report provides state-of-the-art information concerning the risk of mildly flammable refrigerants. The 2012 progress report is freely downloadable. We hope that this information will be of much interest for risk assessment.

Author contact information

Professor Eiji Hihara, The University of Tokyo, Japan
hihara@k.u-tokyo.ac.jp

References

- [1] Hihara, E. (ed.) 2013. *Risk Assessment of Mildly Flammable Refrigerants, 2012 Progress Report, JSRAE*. Available at http://www.jsrae.or.jp/info/2012progress_report_e.pdf
- [2] Takizawa, K.; Tamura, M. 2013. *Progress Report by Research Institute for Innovation in Sustainable Chemistry, AIST*, *ibid*, pp.43-54.
- [3] Imamura, T.; Sugawa, O. 2013. *Physical Hazard Evaluation of A2L-Class Refrigerants using Several Types of Conceivable Accident Scenarios*, *ibid*, pp.35-42.
- [4] Hihara, E.; Hattori, T.; Ito, M. 2013. *Progress of the University of Tokyo*, *ibid*, pp.13-28.

Low GWP R410A Alternatives in Heat Pumps: Performance and Environmental Characteristics

Ankit Sethi, Samuel Yana Motta, Mark Spatz, Honeywell USA

This paper is focused on the performance and environmental characteristics of low global warming potential (GWP) molecules which have been developed as alternatives to R410A for use in air source heat pumps. Experiments were performed in a typical 3.5 kW (1 ton) heat pump with R410A and a low GWP alternative-L41 (R32/R1234ze(E)/Butane 68%/29%/3%). Thermodynamic and system simulations were carried out using low GWP refrigerant properties and compared to R410A. A Life Cycle Climate Performance (LCCP) analysis of the new LGWP refrigerants is presented. L41 shows promise in these applications and warrants further development.

Introduction

Refrigerants that are in common use today, HFCs, have the benefits of high energy efficiency, safety in use, properties that enable the design of cost effective systems, and from an environmental perspective they have no impact on stratospheric ozone. Despite these attributes, the air conditioning and refrigeration industry is now looking for replacements due to the growing global concerns around climate change since many of these refrigerants have relatively high global warming potential. New molecules with the positive attributes of both high thermal performance and low environmental impact, to name a few necessary characteristics, are currently in development. These materials maintain the high level of system efficiency we are accustomed to with fluorocarbon refrigerants but with significantly lower global warming impact than current refrigerants. They also exhibit significantly lower flammability characteristics than the much more flammable hydrocarbons. Replacements for refrigerant R410A which is widely used in air source heat pumps will be discussed. This paper will focus on the performance and environmental characteristics of the refrigerants blend L41 (R32/R1234ze(E)/Butane 68%/29%/3%) and compare it with R410A

Thermodynamic Analysis

Table 1 shows the results for thermodynamic analysis performed for R410A and L41. This type of analysis was performed at typical a/c temperature conditions using thermodynamic data from the NIST database REFPROP 9.0. The table shows that L41 offers about 78 % reduction in GWP which will reduce the direct emissions substantially.

The thermodynamic analysis shows that L41 has about 10 % lower capacity and 2 % higher efficiency than R410A. The mass flow rate of L41 is about 70 % of R410A due to which pressure drop in the system may be lower. A larger compressor will be required with L41 to match R410A's capacity. The suction and discharge pressures for L41 are lower than R410A and the pressure ratio is also similar to R410A. The discharge tem-

perature is only about 8 °C higher than R410A. It should be noted that these calculations just take into account thermodynamic properties. To establish the viability of a refrigerant candidate the refrigerant must satisfy a complex mosaic of properties through comprehensive testing.

System Performance

A detailed system model was used to get a more accurate understanding of system performance and efficiency. The model employed for the simulations (Genesym™, Yana Motta, 2002) represents a vapor compression refrigeration cycle operating at steady-state conditions. The detailed description and accuracy of the model is provided in paper presented at Earth Technology Forum by Spatz (2004). The model was calibrated with experimental data obtained for R410A at AHRI (2008)

THERMODYNAMIC COMPARISON				
Parameter	Units	R410A	L41	
		Value	Value	Rel. to R410A
GWP	-	1924	461	22%
Capacity	W	3502	3113	89%
COP	-	4.51	4.61	102%
Mass Flow	kg/hr	73.2	49.7	68%
Suction Pressure	Bar	9.9	8.2	83%
Discharge Pressure	Bar	24.2	20.7	86%
Pressure Ratio	-	2.44	2.51	103%
Discharge Temperature	°C	70	78	111%

Evap. Temp.=7.0 °C, Cond. Temp.=40.0 °C, Superheat=5.0 °C, Subcooling=5.0 °C, Isent. Eff.=65%, Vol. Eff.=95%, Comp. Disp.=0.000581 m³/s

Table 1. Thermodynamic Analysis

standard conditions for cooling and heating.

The chosen baseline system is a ductless split (mini-split) heat pump. The system was originally designed to operate with R-410A. The system has a rated capacity of 3.5 kW, COP of 3.3 in cooling mode and capacity of 4 kW, COP of 3.7 in heating mode. The system had a variable speed rotary compressor with fin-tube heat exchangers as outdoor and indoor coils with internally micro-finned tubes. Compressor displacements were adjusted to give identical cooling capacities at 28 °C for all refrigerants. The compressor displacement was increased by 14 % to match capacity for L41. Further work would be needed to determine this impact of compressor type on performance with different refrigerants. The outdoor and indoor heat exchangers were the same for both the refrigerants.

Results

The model was run over the complete operating range of -15 to 52 °C outdoor temperatures. Figure 1 shows the efficiency of all refrigerants for cooling conditions. For cooling conditions L41 shows efficiency similar to R410A for ambient temperatures less than 40 °C. However, for higher ambient temperatures R410A efficiency degrades rapidly and L41

has about 5 % higher efficiency at 52 °C. For heating mode the efficiency of L41 is similar to R410A for the entire range of temperatures. Only for very low ambient temperatures of less than -10 °C R410A shows about 1-2 % higher efficiency. Further improvement in performance of L41 is possible by improving the design of heat exchangers. In sum L41 shows performance similar to R410A, with some advantage at high ambient conditions, with 70 % to 75 % reduction in GWP.

Life Cycle Climate Performance (LCCP) Analysis

In order to determine the environmental impact of the choice of refrigerants for this application, an analysis of both the direct and indirect contributions to global warming were conducted. The direct contributions come from refrigerant emissions and the indirect contributions are due to the burning of fossil fuels to supply the power consumed by the equipment.

The power consumption of a typical heat pump over the course of a year is determined by using a bin analysis using weather data for Beijing in China, Atlanta in the U.S., and four European cities (Paris, Frankfurt, Milan and Madrid). TMY2 data produced

by National Renewable Laboratory and available in BinMaker® Pro v3.0.1 software is used for the analysis. To compensate for the emissions and energy associated with the production of the refrigerants, the latest GWP values reported by Hodnebrog et al. (2013) have been used and are shown in Table 2.

Values of 0.79 and 0.53 kg of CO₂ per kW-hr of electrical production for China and the U.S. respectively and Table 3 shows the results of the determination of the CO₂ equivalent of electrical energy consumption for Europe using a population weighted average of four countries (IEA, 2012). Assumptions needed to complete this analysis were taken from the ADL (2002) report. This included a 2 % annual leakage rate and a 15 % end-of-life loss (taken from split-system unitary a/c since this equipment is very similar in design). A 15-year life was assumed. The impacts were determined by:

$$\text{Direct Effect} = \text{Refrigerant Charge (kg)} \times (\text{Annual loss rate} \times \text{Lifetime} + \text{End-of-life loss}) \times \text{GWP}$$

Eq. (1)

$$\text{Effect} = \text{Annual Power Consumption} \times \text{Lifetime} \times \text{CO}_2 \text{ per kW-hr of electrical production}$$

Eq. (2)

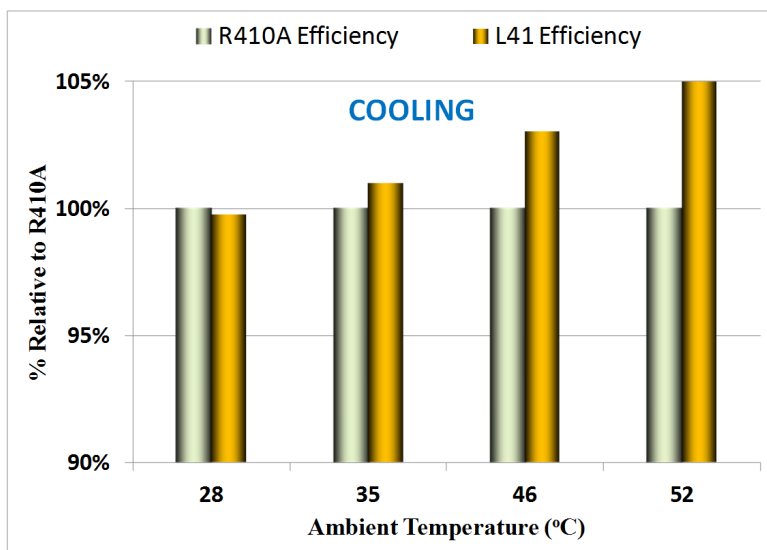

Figure 1. System Efficiency

	Refrigerants	
	R410A	L41
GWP	1924	461
Mfg. Emissions	14	14
Total	1938	475

Table 2. Latest GWP Values

	kgCO ₂ /kW-h	
		Wt. factor
France	0.077	26%
Germany	0.468	32%
Italy	0.423	24%
Spain	0.287	19%
Average	0.314	
Wt factor based on population of countries		

Table 3. Average Emissions Factor for Europe



In order to determine the run time of a heat pump in a given application a load profile was assumed which is shown in Figure 2. Temperatures above the design point will result in insufficient cooling capacity resulting in a room temperature rise. Resistance heaters (at a COP of 1.0) are assumed when the heating load is higher than the heating capacity of the heat pump.

Using this information a LCCP analysis was performed for each region and analysis for Europe is shown in Figure 3. Table 4 shows the direct and indirect emissions for the refrigerants in different regions. It is very clear from these results that the indirect contributors dominate any contributions from refrigerant emissions. In Europe and Atlanta the L41 offers a LCCP reduction of about 3 %, whereas in Beijing the LCCP reduction is 2 %. As more countries try to reduce their emissions from electricity generation the benefits of using L41 will increase further for instance in countries like France, Spain and Brazil which have low value of emissions factor the LCCP reduction could be as much as 20-30 %.

Conclusions

This paper evaluated the performance and lifetime emissions of a low GWP refrigerant, L41, for a typical mini-split heat pump system. Several conclusions can be drawn from these evaluations:

- » The capacity and efficiency of L41 is very similar to R410A. The only change required in the system with L41 was to increase compressor displacement by 14 % to match the cooling capacity of R410A.
- » The indirect effect (or system efficiency) dominates the LCCP of unitary a/c and heat pumps in countries with high emissions factor for electricity generation.
- » The LCCP of L41 is about 2-3 % lower than R410A in the cities evaluated in this study. In countries like France, Ger-

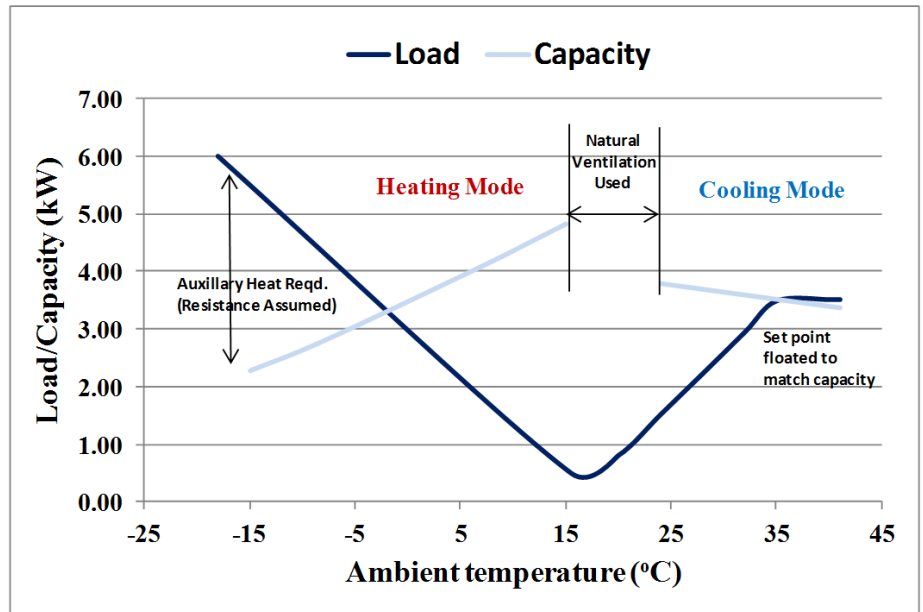

Figure 2. Load Profile vs System Capacity

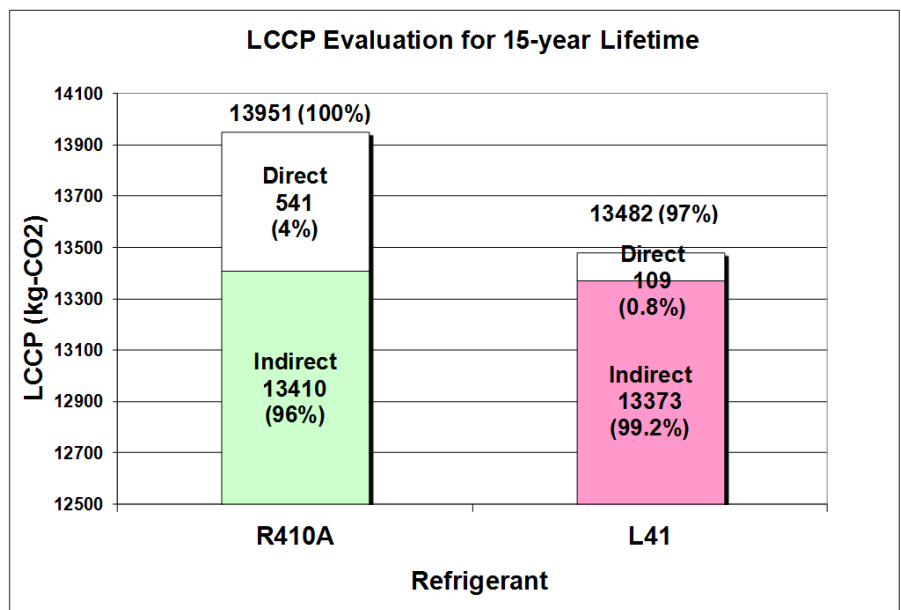

Figure 3. LCCP Analysis for Europe

		Direct	Indirect	Total	Total % R410A
Beijing	R410A	43381	541	43922	100%
	L41	43084	109	43193	98%
Atlanta	R410A	19119	541	19660	100%
	L41	19052	109	19161	97%
Europe	R410A	13410	541	13951	100%
	L41	13373	109	13482	97%

Table 4. Direct and Indirect Emissions

many and Brazil, which have low values of emissions factor, the LCCP would be about 20-30 % lower than R410A. Hence, L41 is a suitable replacement for R410A in air source heat pumps.

- » The capacity and efficiency of L41 is about 2-5 % higher than R410A under high ambient conditions. This indicates that it would be a suitable candidate for replacement of R410A even in cooling only mini-split systems and will offer even larger reduction in LCCP.

base, Boulder, USA.

- [7] Spatz, Mark W., 2004. *Performance and Environmental Characteristics of R-22 Alternatives in Heat Pumps*, Earth Technologies Forum
- [8] Yana Motta, Samuel, 2002. *Genesym: a Vapor Compression Cycle Model*, Honeywell - Buffalo Research Laboratory, Internal Report, Buffalo, USA

Author contact information

Senior R&D Engineer Ankit Sethi,
Honeywell, 20 Peabody St.,
Buffalo NY 14210,
USA
Ankit.Sethi@Honeywell.com

References

- [1] AHRI Standard 210/240-94, 2008. *Unitary A/C and Air Source Heat Pump Standard*, Arlington, VA.
- [2] Arthur D. Little (ADL), 2002. *Global Comparative Analysis of HFC and Alternative Technology for Refrigeration, Air Conditioning, Foam, Solvent, Aerosol Propellant, and Fire Protection Applications*.
- [3] BinMaker® Pro v 3.0.1, InterEnergy Software Gas Technology Institute, Des Plains, IL, USA.
- [4] Hodnebrog, Ø., M. Etminan, J. S. Fuglestedt, G. Marston, G. Myhre, C. J. Nielsen, K. P. Shine, and T. J. Wallington, *Global warming potentials and radiative efficiencies of halocarbons and related compounds: A comprehensive review*, Rev. Geophys., 51, 300–378, 2013
- [5] International Energy Agency (IEA), *CO₂ Emissions from Fuel Combustion Highlights*, Paris, France, 2012
- [6] Lemmon, Eric W., McLinden, Mark O. and Huber, Marcia L., 2010. *NIST Reference Fluid Thermodynamic and Transport Properties – Refprop 9.0*, NIST Std. Data-

European experience of CFC, HCFC and HFC restrictions

Andy Pearson, the United Kingdom

This article highlights for non-experts the way in which European legislation is developed. It reviews the effect that this has had in the past on the control of CFCs and HCFCs and considers the possible implications for the impending control of HFCs.

Introduction

The regulation on fluorinated gases is under revision. Based on a first proposal by the European Commission, the European Parliament's Environmental Committee presented its proposal in November 2012. This created quite a stir across Europe with a wide range of opinions expressed, but it was also clear that many people did not understand the legislative process and were therefore confused by the announcement.

How Europe works

The political structure of Europe is complex and not easy for an outsider to understand. There are 28 member countries in the European Union – they each have their own government but they have agreed to join an alliance and to share some legislative powers. Some people think that this has already gone too far whereas others feel that more centralisation would be beneficial. One key point is that (so far) the European Union does not raise taxes directly. Each member state pays what amounts to a "membership fee", but in many cases they also receive grants and rebates so it can be difficult to work out who pays for what. Individual countries can choose to opt into or out of some of the regulations, for example use of the Euro currency but other requirements such as trade regulations and health & safety law are mandatory. In some cases national law is permitted to be more stringent than the EU requirements, but in other areas this would be a trade barrier and is not

allowed. This results in three types of legislation. The first type is where the Union has exclusive competence to make directives and conclude international agreements, for example in establishing competition rules for the internal market. In many cases however (the second type) the member states share competence with the Union, with one or other party taking the lead. For example the Union leads in environmental legislation and energy efficiency requirements but individual member states lead in economic, employment and social policies. In a few cases (the third type), such as industry and tourism the Union can carry out actions to support, co-ordinate or supplement Member States' actions.

The European government mechanism has three facets. The European

Commission is the only body that can suggest a new piece of legislation. The commission consists of 28 representatives of member States each being responsible for a certain political area, for example energy, the environment, enlargement. These representatives are called Commissioners.

There is the European Council of ministers where ministers as well as heads of governments meet on a regular basis.

The European Parliament, consisting of 766 elected members representing the European citizen. The commission proposes new legislation and the Council of Ministers and the European Parliament negotiate some form of agreement on how the Commission's requirements shall be met. Once this agreement

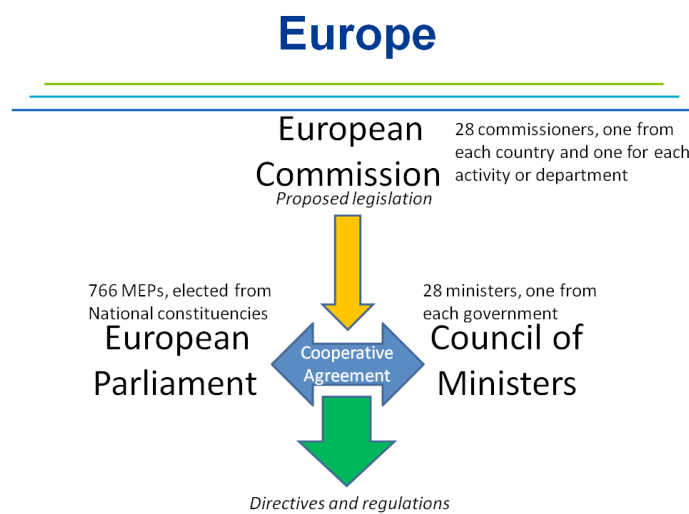

Figure 1. Political structure of Europe

has been reached, directives (which are turned into national law by each Member State) and regulations are passed by the parliament. Some directives become law exactly as written to ensure that there is a common approach right across the Union. In other cases the directive is “transposed” into national law, whereby each nation passes its own version of the directive in order to incorporate national variances. The “f-gas regulations” are in this latter category.

What happened with CFCs

In the 1990s the European Community decided to phase-out CFCs more rapidly than was required by the Montreal Protocol. This accelerated phase-out was initially adopted as national law by some countries, for example Germany, and was then adopted by the European Economic Community (EEC) as it was known at that time. This accelerated phase-out included a ban on production of CFCs within the European Union from 1996 onwards and a service ban from 2000 onwards. One major success of this policy was the switch of refrigerants to hydrocarbons for domestic refrigerators. In 1992, shortly before the German proposal, nearly all refrigerators in the world used CFC-12. In the rest of the world this was switched, under the Montreal Protocol requirements, to HFC-134a but in Europe the switch was initially to a mixture of propane and isobutane, and latterly to isobutane only. By 2012 about 90 % of all refrigerators in Europe used isobutane, representing about one-third of global production of refrigerators. It is expected that other parts of the world will follow suit and by 2020 three-quarters of refrigerators in the world will use hydrocarbons. Hydrocarbons also replaced CFCs in display cases, bottle coolers and small chillers, although not as quickly nor as completely as in the domestic refrigerator market.

What is happening with HCFCs

HCFC-22 and HCFC-141b were added to the European regulation on ozone-depleting substances in the mid 1990s. Their use in new systems was prohibited progressively from 2000 to 2002 and use in service was banned from 2010, except for recycled refrigerant which can be used up until 2015, provided it is still available. This is about ten years ahead of the Montreal Protocol phase-out schedule.

What will happen with HFCs

The f-gas regulations were introduced in 2006 to implement some controls on the emission of greenhouse gases. The original legislation was a bit weak, and implementation has been patchy, but it produced a powerful knock-on effect. Several member states have enacted tougher rules, for example Denmark and Austria and neighbouring countries who are not member states are taking the same approach, for example Switzerland and Norway. Now the second generation of f-gas regulations are on their way. A proposal for a new regulation was published by the European Commission in November 2012. It is much tougher than the original 2006 regulation, including phase down of HFC use based on global warming potential. It is more sector-specific and includes bans on the use of HFCs in certain products. One reason that the proposal is tougher than before is because Europe is seeking to achieve a total carbon emission reduction of 95 %, using 1990 as the base year, by 2050. Although HFC emissions are a small part of our total carbon-equivalent emissions at present, counting for about 2 % of total emissions, by 2050 this would be 40 % of the total remaining emissions if the f-gas emissions remain at current levels. In the proposal several interesting points are made. Denmark is noted as an example of the successful introduction of natural refrigerants in place of HFCs. This leads to the observation

that HFC reduction is an easy target compared to other industry sectors. The legislation is targeted at improving market opportunities for alternative technologies and at bringing HFCs into the Montreal Protocol emission management schemes.

Since the publication of the Commission’s proposal the Parliament has weighed-in with a raft of proposed amendments. However rather than reducing the more extreme aspects of the proposal they seem in some cases to have gone even further. We are currently in the period of the co-operative legislative procedure and the Commission’s proposal and the Parliament’s comments are being debated in the Council. A number of meetings have been set up between the environmental experts of the Member States to establish a council position. This will then be debated between the three parties in “trialogue” meetings to come up with a final text. If agreement can be found a vote on the compromise document will then be held in the European parliament. This vote is scheduled for 13.1.2014.

So far some environmentalists say that the revised regulation does not go far enough. On the other hand some industry lobby groups say that we cannot cope with such a rapid rate of change. The frightening thought is that in this instance both views might be correct. There are still large gaps in the proposal – for example commercial and industrial refrigeration and heat pumps, re not clearly defined and the definitions used are different in some cases from the use of the terms by the general public. It is also not clear whether “chillers” are in the scope of the regulation, and if so, where. Most importantly it is noted that the regulation could have a seriously damaging effect on the market for small heat pumps, which is expected to be a key part of the effort to reach the 2050 carbon emission reduction target. Thus focussing on f-gas only instead of taking a systems perspective may even lead to more emission, if a heat pump is not installed and a

fossil fuel heater is used instead!

Where to now?

When the Commission's proposal was launched last November it was expected that it would be accepted by the Parliament during 2013 and would be enacted nationally in the Member States by 2014 to enter into force in 2015. The Parliament have introduced a larger debate than was envisaged so it is not yet clear whether the 2013 date can be achieved. If it is delayed then the implementation may also have to slip a bit. It is particularly important to note that this timescale, even with a short delay, is much faster than was achieved with either CFCs or HCFCs. However in the present case the alternatives in many cases are less obvious than they were before. The questions are getting harder and the time given to answer them is being reduced.

Conclusions

Europe took a proactive, unilateral and ambitious stance regarding CFCs and HCFCs. In hindsight we can say that it worked. Europe is planning to do the same thing, perhaps even more ambitious, with HFCs but this time it is not so clear, particularly in the case of small heat pumps, that we have something to move to. Whether you favour fluorinated or inorganic chemicals it is clear that there is a lot more development work required.

Author contact information

*Dr. Andy Pearson,
Star Refrigeration Ltd,
Glasgow G46 8JW,
United Kingdom
apearson@star-ref.co.uk*

A new centre for Swedish shallow geothermal energy

Signhild Gehlin, Sweden

The Swedish Centre for Shallow Geothermal Energy (Svenskt Geoenergicentrum) was set up on March 1st 2013 and forms a gateway to Swedish know-how in ground-source heat pumps and shallow geothermal energy. The centre is run by Signhild Gehlin, and guided by an advisory board with representatives from all parts of the Swedish shallow geothermal market. The new centre provides training, information and contacts within the field for the Swedish and Nordic market.

Introduction

There are moments in your life when something that seems too good to be true, contrary to most cases, actually is true. For real. Such was the case when I was asked by the CEO of the Swedish Drillers' Association if I would like to take on the role of establishing a Swedish centre of excellence for shallow geothermal energy. That was an offer I couldn't resist. The Swedish Centre for Shallow Geothermal Energy (Svenskt Geoenergicentrum) came into being on March 1st 2013, and here I am, running it.

TED – the cause

My own interest in underground thermal energy storage and ground-source heat pumps (GSHP) began in 1995 when I, during my final year of engineering studies at the University of Luleå, Sweden, took a course in Renewable Energy. The student project that I undertook at the end of the course, together with three fellow students, was to design a mobile test device for thermal response testing (TRT) of ground heat exchangers. The project was initiated and supervised by Professor Bo Nordell, who had been inspired by the work done by Palne Mogensen in 1983 [1]. After the course, Professor Nordell suggested that I and my fellow student Catarina Eklöf should have the test device built, experiment with it, and report on it in our Master Thesis work in the spring of 1996. We accepted the offer and 'TED', the very first mobile thermal response test

device in Sweden, was born. TED already had, I would learn a couple of years later, a sibling at Oklahoma State University, running its first tests at the very same time [2].

In the summer of 1996 Catarina and I presented our Master Thesis 'TED – A Mobile Equipment for Thermal Response Test' [3] at the IEA ECES Annex 8 meeting in Halifax before the world's leading experts on underground thermal energy storage. The response from the experts was very encouraging, and on our return to Sweden we were asked by Professor Nordell to continue the work within a PhD program. I had not yet had enough of TED, so I gladly accepted the PhD position and spent another five years with TED and my response tests. My licentiate thesis was published in 1998 [4] and I concluded my PhD work in December 2002 [5].

After my dissertation I left academia to work as the technical secretary of SWEDVAC - the Swedish Society of HVAC Engineers, and later also as chief editor of the HVAC magazine Energi&Miljö, and in 2009 I became General Secretary of SWEDVAC. The work at the society gave me little opportunity to work with GSHPs, but I sought to keep updated on developments within TRT and geothermal energy.

I always nurtured the idea of working with shallow geothermal energy and energy storage again. In 2012 the opportunity arose, with the offer

to start the new Svenskt Geoenergicentrum. I began my new position as technical expert at the centre on March 1st 2013. At present, the centre consists of Johan Barth (CEO) and myself.

Gateway to know-how

GSHPs and shallow geothermal energy have a wide market in Sweden, with about a quarter of all known installed systems in the world, and 40 years of qualified experience and development. With increasing interest for larger shallow geothermal systems, and new applications, combined with the demand for sustainable and renewable energy systems in Sweden and all over Europe, there is clearly a need for an independent institution where all information on shallow geothermal applications and research within Sweden and the Nordic countries can be brought together and disseminated. Svenskt Geoenergicentrum was initiated to meet the demand for such a service, and the build-up phase is now ongoing.

Although the aim of the centre is primarily to serve the Swedish and Nordic market, its work will not be limited to the Nordic countries. Research and development is not a national matter, but must reach globally. Hence Svenskt Geoenergicentrum will serve as a gateway to Swedish shallow geothermal know-how, and establish cooperation and exchange with experts, organisations and research institutions abroad.



Advisory board

Svenskt Geoenergicentrum has an advisory board with representatives from all parts of the Swedish shallow geothermal market. Consultants, contractors, researchers, manufacturers and property-owners are all represented on the advisory board, and provide input on prioritised areas and projects. Good communication with both users and providers within shallow geothermal is a crucial point in the work of the centre.

Positive response

The response to the Centre has been very positive from the Swedish and Nordic markets, and it is now possible to affiliate to the Centre. Affiliates are provided with continuous information on shallow geothermal energy through the monthly newsletter (in Swedish) that I am editing, and the magazine *Svensk Geoenergi* (Swedish Shallow Geothermal). A web page is under construction, and will provide information about relevant publications, seminars etc. as well as a database with Swedish geothermal systems and applications.

On October 4th, Svenskt Geoenergicentrum will hold its first annual conference 'Geoenergidagen', preceded by a workshop. It will take place at Arlanda Airport and cover the process from pre-design of geothermal systems, through environmental and economic issues, to operation and maintenance. I believe that there is a definite need for such an annual meeting, and the response from the sector confirms this.

Education

The GSHP market in Sweden and in Europe depends not only on research and development, but also on the availability of appropriately skilled personnel for designing, drilling and installation. The Geotrained project, supported by the European Commission Altener programme, has developed an educational programme and a certification programme for geothermal installations, with the vision of its being recognised all over

Europe. Svenskt Geoenergicentrum is the National Education Coordinator for Sweden within Geotrained, and will provide Geotrained-certified training programmes for shallow geothermal drilling and design. The Geotrained certification body is presently being formed, with its base in Brussels, and a meeting will be held in southern Sweden in the autumn, with Svenskt Geoenergicentrum as the host.

Research

Much of the Swedish GSHP success saga was stimulated by support from BFR – the Swedish Council for Building Research - which actively supported research in GSHP and geothermal systems in the 1980s and 1990s. Since BFR's closure at the end of the 1990s, funding of shallow geothermal research in Sweden has decreased and become less coordinated. Svenskt Geoenergicentrum aims to stimulate research in the shallow geothermal systems area, by initializing and supporting research projects in this field, and contributing to dissemination of research results within Sweden as well as internationally. Affiliates of the centre are encouraged to suggest suitable areas of research and smaller studies of interest to the market.

We have, since the centre opened, initiated and supervised two diploma theses from Lund University, that were published in June. The topics of the theses are the effect of deviation of boreholes from vertical on larger geothermal systems, and evaluation of ten years of operation of a 14-borehole GSHP system for a residential building in Lund.

Through the centre, I am currently involved in a couple of research studies in cooperation with Swedish and American researchers, and the results will be published at ASHRAE conferences in 2014 and the IEA Heat Pump Conference in 2014. The papers will subsequently be made available in Swedish through the centre in 2014.

Geothermal statistics

Providing good statistics for geothermal energy in Sweden is one important task that Svenskt Geoenergicentrum has taken on. The official national statistics on geothermal energy in the Swedish energy system have so far been of somewhat limited quality. In the official Swedish statistics, geothermal energy is considered as an energy saving, and the only part that is quantified is the electric usage of ground-source heat pumps. The centre has initiated a project to provide officially approved data on the contribution of geothermal energy to the Swedish energy system, and I am greatly looking forward to shedding more light on the real energy contribution from shallow geothermal energy, whether connected to a heat pump or not. Present estimation suggests that 12.6 TWh [6] per year of heating and cooling are provided by shallow geothermal energy systems in Sweden, which represents about 10 % of the entire global shallow and deep geothermal energy production, and places shallow geothermal energy as the third largest renewable energy source in Sweden, after hydro power and biomass [7].

Many of the obstacles that shallow geothermal projects may meet are political obstacles. One example is the somewhat inflamed discussion on the greenhouse gas impact of electricity production, and all that it means for heat pump applications. Some advocates of using the marginal electricity principle for life cycle assessment claim that all new electricity usage in Sweden effectively comes from fossil fuels in central Europe. Contrarily, others claim that the 2005 system of green certificates in Europe results in no change at all in greenhouse gas emissions, as the CO₂ limit is already fixed.

Heat pump applications undoubtedly make up most of the current shallow geothermal energy systems, which means that the question of environmental assessment of electricity could have a significant impact on public policy. Svenskt Geoener-

gicentrum arranged a panel discussion on environmental assessment of electricity on July 2nd at the biggest annual political event in Sweden at Almedalen, Gotland. Representatives from academia, the Swedish Energy Agency, power production industry as well as district heating industry and real estate owners took part in the discussion. A new informative film (in Swedish) on this subject is available at www.geotec.se, and a report is under production.

Six months have passed since I started working for Svenskt Geoenergicentrum. It is a fascinating area to work in, and I look forward to working with people around the world who share my fascination for GSHP and shallow geothermal energy systems.

Author contact information



Signhild Gehlin,
PhD., Technical expert,
signhild.gehlin@geoenergicentrum.se

Svenskt Geoenergicentrum
(Swedish Centre for Shallow Geothermal Energy)
Box 11 27, 221 04 Lund, Sweden
www.geoenergicentrum.se



References

- [1] Mogensen P. (1983). *Fluid to Duct Wall Heat Transfer in Duct System Heat Storages*. Proc. Int. Conf. On Subsurface Heat Storage in Theory and Practice. Stockholm, Sweden, June 6-8, 1983, p. 652-657.
- [2] Austin W. A. (1998). *Development of an in-situ system for measuring ground thermal properties*. Master's thesis. Oklahoma State University.
- [3] Eklöf, C., and Gehlin, S. (1996). *TED - A Mobile Equipment for Thermal Response Test*. Master Thesis 1996:198E, Luleå University of Technology, Sweden.
- [4] Gehlin S (1998). *Thermal Response Test – In-situ measurements of thermal properties in hard rock*. Licentiate thesis, 1998:37. Luleå University of Technology.
- [5] Gehlin S., (2002). *Thermal Response test – Method Development and Evaluation*. Doctoral Thesis. Luleå University of Technology.
- [6] Lund J. W., et al. (2010). *Direct Utilization of Geothermal Energy 2010 Worldwide Review*. Proceedings of the World Geothermal Congress 2010, Bali, Indonesia, April 25-30 2010.
- [7] Swedish Energy Agency (2012). *Energy in Sweden 2012*.

Summary of 2013 ASHRAE Annual Meeting

Compiled from notes by Yunho Hwang and Van Baxter, USA

The Conference, held June 22-26, in Denver, Colorado, saw the highest attendance numbers for an Annual Conference in over a decade, with close to 1,900 attendees. The Conference's Technical Plenary and new track keynote addresses ranked high in attendance, addressing trends in data center design, the National Renewable Energy Laboratory's research facility and program, and the future of sustainable energy. The conference's technical programs included the following tracks:

- Track 1: Research Summit
- Track 2: Integrated Project Delivery
- Track 3: Building Energy Modeling vs. Measurement & Verification - Closing the Gap
- Track 4: Mile-High Efficiency & Equipment
- Track 5: Renewable & Alternative Energy Sources
- Track 6: HVAC&R Systems & Equipment
- Track 7: HVAC&R Fundamentals & Applications
- Track 8: Building Energy Quotient
- Track 9: Meetings

Overall Highlights and Observations

- ASHRAE made a very successful effort to improve the overall quality of technical papers and conference papers.
- ASHRAE is thinking of arranging "mini-conferences", which would hold 15 to 20 seminars.
- A lot of work done on net-zero energy buildings, and low GWP refrigerants.
- Many final test reports for low-GWP Alternative Refrigerants Evaluation Program (AREP) program are available at http://www.ahrinet.org/ahri+low_gwp+alternative+refrigerants+evaluation+program.aspx. AHRI encourages attendants to read them.
- VRF systems gain more and more attention. We heard some

discussions focused on their performance under low temperature heating and high temperature cooling applications.

- Indoor air quality and thermal comfort were being discussed a lot. ASHRAE offers free download of "Indoor Air Quality Guide: Best Practices for Design, Construction and Commissioning," designed for architects, design engineers, contractors, commissioning agents and all other professionals concerned with indoor air quality.
- Verification and validation on energy modeling is another hot topic
- William P. "Bill" Bahnfleth, Ph.D., P.E., Fellow ASHRAE, ASME Fellow, took office as the Society's 2013-2014 president.

Some selected papers are briefly presented below.

Technical Paper Session 6 – Reducing Environmental Impact: Ventilation with Heat Recovery and Improved Flammability Testing of Low GWP Refrigerants Principles of Energy Efficient Ammonia Refrigeration Systems

A. Q. Mohammed, *et al.*, University of Dayton, Dayton, OH

- This study presents six possible improvements for large ammonia systems in food storage refrigeration applications.
- Annual energy saving is used as criterion to evaluate the benefit of each improvement using a simple vapor compression cycle model to simulate the performance.
- The results indicate that by employing dual suction, the performance improvement is most beneficial.
- By recuperating the condensing heat for water heating, the total primary energy savings will be maximised.

Energy and Cost Efficient Ventilation Systems with Heat Recovery: State of the Art and Enhancement

Rainer Pfluger, *et al.*, University of Innsbruck, Innsbruck, Austria

- This study presents several state-of-the-art technologies already commercially available to improve the duct based air-conditioning system performance, and several research in projects progress to further enhance their benefits.
- Among them, coaxial duct as one way to get a counter flow heat recovery "heat exchanger" between outdoor fresh air and exhaust air is a good example.
- Some other technologies include mass flow balancing control using pressure drop measurements or flow rate measurements, and counter flow heat exchanger made of folded paper for heat recovery purpose.

Seminar 43: VRF Applications in Cold Climate: Success Stories

Variable Refrigerant Flow systems are well known for efficient performance and flexible design. But how should they be applied in very cold climates? Low ambient conditions often present designers with a unique challenge. This session presents two case studies with different solutions for cold climate VRF applications.

Best Practices for Air-Source VRF in Cold Climates

Shawn Brill, P.E., Member, Bighorn Consulting Engineers, Co., Grand Junction, CO

- The author presents a case study on VRF system design and commissioning for a hospital in cold climate area (high altitude).
- Several special design aspects are discussed to address the heating load degradation at low temperature operating conditions and heat recovery options are discussed.

Hybrid VRF and Hydronic in a Hotel Application

Maciej Sobczyk, P.E., Geoclima Mechanical Engineering Ltd., West Vancouver, BC, Canada

- The author presents a case design for a hotel in cold climate using hybrid VRF system with supplementary radiative heater.
- Heat recovery operating mode is designed to achieve heating/cooling for north/south side of the building with high efficiency.
- Several unique design issues are discussed and addressed. The field test results indicate that the VRF system is able to provide heating during most of the time.

Conference Paper session 7 – Reducing climate impacts of Refrigeration Systems

- Xudong Wang, AHRI, summarized results of testing of several low-GWP alternative refrigerants and blends vs. current baseline refrigerants under the AHRI Alternative Refrigerants Evaluation Program (AREP). The presentation focused on testing of commercial ice machines, bottled beverage coolers, and refrigeration units for refrigerated trailers. He presented data from tests conducted by Hussmann, Thermo King, and Manitowac. Details of the presentation including test results and compositions of the refrigerants tested are included in the paper. Full details of all test results (air-conditioning and refrigeration applications may be found at www.ahrinet.org/ahri+low_gwp+alternative+refrigerants+evaluation+program.aspx)
- Dennis Dorman, Trane and chair of ASHRAE SSPC 15 (safety standard) discussed allowable charge limits for 2L refrigerants (low flame propagation speed, difficult to ignite). SSPC 15 is developing rules for 2L refrigerant charge limits (RCL) for safe application of equipment in occupied spaces. Generally they are moving toward defining the RCL for an application such that

there is no possibility of ignition if the full charge is released into a space and is fully dispersed into that space (RCL > 25 % of the lower flammability limit (LFL) of the refrigerant used). They are also requiring continuous ventilation of the space at 1.5 ACH (30 ACH for emergency cases of large refrigerant releases).

- Brian Fricke presented the paper “Energy Efficiency and Environmental Impact Analysis of Supermarket Refrigeration Systems.” The paper summarized LCCP evaluations of several alternative commercial refrigeration systems with standard and high efficiency display cases and storage rooms. Systems evaluated included a baseline multiplex direct expansion (DX) system with R404A, cascade secondary loop systems using a range of primary (high-side) refrigerants and secondary loop fluids (glycol or CO₂), and a transcritical CO₂ booster system.

Author contact information

- Yunho Hwang
yhhwang@eng.umd.edu
- Van D. Baxter,
baxtervd@ornl.gov



Events

This section lists exhibitions, workshops, conferences etc. related to heat pumping technologies.

2013

3-4 October
7th CLIMAMED Mediterranean Congress of Climatization
 Istanbul, Turkey
<http://www.climamed.org/>

15-16 October
Heat Pump Summit 2013
 Nürnberg, Germany
<http://www.hp-summit.de/en/symposium/>

15-18 October
IAQ 2013 - Environmental Health in Low Energy Buildings
 Vancouver, British Columbia, Canada
<https://www.ashrae.org/membership--conferences/conferences/ashrae-conferences/iaq-2013>

19-21 October
ISHVAC (International Symposium on Heating, Ventilation and Air Conditioning)
 Xi'an, China
<http://www.ishvac2013.org/v2/index.php>

3-5 November
ACEEE Hot Water Forum
 Atlanta, USA
<http://www.aceee.org/conferences/2013/hwf>

4-8 November
Interclima + elec
 Paris, France
http://www.interclimaelec.com/site/GB/Conferences__Events/Presentation,I5151.htm

4-6 December
44th International HVAC&R Conference
 Belgrade, Serbia
<http://www.kgh-kongres.org/44kongres/eng/index.html>

2014

16 January
AHRI Low-GWP AREP Conference
 New York, USA
https://netforum.ahrinet.org/eweb/DynamicPage.aspx?Site=ahri&WebKey=a126175cf185-4cd9-b376-3e442e365c59&RegPath=&REg_evt_key=f8e11179-ddcb-40ba-a9a3-075dfba874ba

18-22 January
ASHRAE Winter Conference
 New York, USA
<http://ashraem.confex.com/ashraem/w14/cfp.cgi>

28-31 January
HVAC&R Japan
 Tokyo, Japan
<http://www.hvacr.jp/eng/index.html>

24-26 February
First International Conference on Energy and Indoor Environment for Hot Climates
 Doha, Qatar
<http://ashraem.confex.com/ashraem/ihc14/cfp.cgi>

26-28 February
49th AiCARR International Conference
 Rome, Italy
http://www.aicarr.org/Pages/Convegna/Roma_2014/Home_English.aspx

31 March – 3 April
2014 International Sorption Heat Pump Conference
 College Park, Maryland, USA
<http://www.ceee.umd.edu/events/ISHPC2014>

7-8 April
High Performance Buildings Conference
 San Francisco, USA
<http://www.hpbmagazine.org/hpb2014>

24-25 April
Efficient, High Performance Buildings for Developing Economies
 Manila, Philippines
<https://www.ashrae.org/membership--conferences/conferences/ashrae-conferences/efficient-high-performance-buildings-for-developing-economies>

12-16 May
11th International Energy Agency Heat Pump Conference
 Montreal, Canada
<http://www.iea-hpc2014.org/>

23-25 June
3rd IIR Conference on Sustainability and the Cold Chain
 London, UK
<http://www.ior.org.uk/iccc2014>

28 June – 2 July
ASHRAE Annual Conference
 Seattle, USA
<http://ashraem.confex.com/ashraem/s14/cfp.cgi>

14-17 July
Purdue Conference: 22nd International Compressor Engineering Conference
 West Lafayette, Indiana, USA
<https://engineering.purdue.edu/Herrick/Events/2014Conf/index.html>

In the next Issue
Heat pumps for cold climates

Volume 31 - No. 4/2013

International Energy Agency

The International Energy Agency (IEA) was established in 1974 within the framework of the Organisation for Economic Co-operation and Development (OECD) to implement an International Energy Programme. A basic aim of the IEA is to foster co-operation among its participating countries, to increase energy security through energy conservation, development of alternative energy sources, new energy technology and research and development.

IEA Heat Pump Programme

International collaboration for energy efficient heating, refrigeration and air-conditioning

Vision

The Programme is the foremost worldwide source of independent information and expertise on environmental and energy conservation benefits of heat pumping technologies (including refrigeration and air conditioning).

The Programme conducts high value international collaborative activities to improve energy efficiency and minimise adverse environmental impact.

Mission

The Programme strives to achieve widespread deployment of appropriate high quality heat pumping technologies to obtain energy conservation and environmental benefits from these technologies. It serves policy makers, national and international energy and environmental agencies, utilities, manufacturers, designers and researchers.

IEA Heat Pump Centre

A central role within the programme is played by the IEA Heat Pump Centre (HPC). The HPC contributes to the general aim of the IEA Heat Pump Programme, through information exchange and promotion. In the member countries (see right), activities are coordinated by National Teams. For further information on HPC products and activities, or for general enquiries on heat pumps and the IEA Heat Pump Programme, contact your National Team or the address below.

The IEA Heat Pump Centre is operated by



SP Technical Research Institute of Sweden

IEA Heat Pump Centre
SP Technical Research
Institute of Sweden
P.O. Box 857
SE-501 15 Borås
Sweden

Tel: +46 10 516 55 12

E-mail: hpc@heatpumpcentre.org

Internet: <http://www.heatpumpcentre.org>

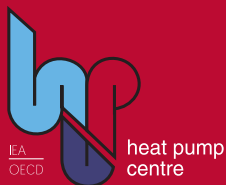

National team contacts

AUSTRIA

Prof. Hermann Halozan
Consultant
Waltendorfer Höhe 20
A-8010 Graz
Tel: +43 316 422 242
hermann.halozan@chello.at

CANADA

Dr. Sophie Hosatte
CanmetENERGY
Natural Resources Canada
1615 Bd Lionel Boulet
P.O. Box 4800
Varennes
J3X 1S6 Québec
Tel: +1 450 652 5331
sophie.hosatte@nrcan.gc.ca

DENMARK

Mr. Svend Pedersen
Danish Technological Institute
Refrigeration and Heat Pump Technology
Kongsvang Alle 29
DK-800 Aarhus C
Tel: +45 72 20 12 71
svp@teknologisk.dk

FINLAND

Mr. Jussi Hirvonen
Finnish Heat Pump Association
SULPU ry
Lustetie 9
FI-01300 Vantaa
Tel: +35 8 50 500 2751
jussi.hirvonen@sulpu.fi

FRANCE

Mr. David Canal
ADEME
Service des Réseaux et des
Energies Renouvelables
500 route des Lucioles
FR-06560 Valbonne
Tel: +33 4 93 95 79 19
david.canal@ademe.fr

GERMANY

Prof. Dr.-Ing. Dr. h.c. Horst Kruse
Informationszentrum Wärmepumpen
und Kältetechnik - IZW e.V.
c/o FKW GmbH
DE-30167 Hannover
Tel: +49 511 167 47 50
email@izw-online.de

ITALY

Dr. Giovanni Restuccia
Italian National Research Council
Institute for Advanced Energy Technologies
(CNR - ITAE)
Via Salita S. Lucia sopra Contesse 5
98126 Messina
Tel: +39 90 624 229
giovanni.restuccia@itae.cnr.it

JAPAN

Mr. Takeshi Hikawa
Heat Pump and Thermal Storage
Technology Center of Japan (HPTCJ)
1-28-5 Nihonbashi Kakigiracho
Chuo-ku, Tokyo 103-0014
Tel: +81 3 5643 2404
hikawa.takeshi@hptcj.or.jp

NETHERLANDS

Mr. Onno Kleefkens
Agentschap NL
Divisie NL Energie en Klimaat
P.O. Box 8242
Croeselaan 15
3503 REUtrecht
Tel: +31 88 620 2449
onno.kleefkens@agentschapnl.nl

NORWAY

Mr. Bård Baardsen
NOVAP
P.O. Box 5377 Majorstua
N-0304 Oslo
Tel: +47 22 80 50 30
baard@novap.no

SOUTH KOREA

Mr. Hyun-choon Cho
KETEP
Union Building, Tehyeonro 114-11
Department of Renewable Energy
Gangnam-gu, Seoul
Republic of Korea 135-280
Tel: +82 2 3469 8302
energy@ketep.re.kr

SWEDEN

Ms. Emina Pasic (Team leader)
Swedish Energy Agency
Energy Technology Department
Bioenergy and Energy Efficiency Unit
Kungsgatan 43
P.O. Box 310
SE-631 04 Eskilstuna
Tel: +46 16 544 2189
emina.pasic@energimyndigheten.se

SWITZERLAND

Mr. Martin Pulfer
Swiss Federal Office of Energy
CH-3003 Bern
Tel: +41 31 322 49 06
martin.pulfer@bfeadmin.ch

UNITED KINGDOM

Ms. Penny Dunbabin
Department of Energy & Climate
Change (DECC)
Area 6D, 3-8 Whitehall Place
London SW1A 2HH
Tel: +44 300 068 5575
penny.dunbabin@decc.gsi.gov.uk

THE UNITED STATES

Mr. Van Baxter - Team Leader
Residential Building and Equipment Research
Engineering Science and Technology Division
Oak Ridge National Laboratory
P.O. Box 2008, Building 3147
Oak Ridge, TN 37831-6070
Tel: +1 865 574 2104
baxtervd@ornl.gov

Ms. Melissa Voss Lapsa - Team Coordinator
Oak Ridge National Laboratory
Engineering Science and Technology Division
Bethel Valley Road
P.O. Box 2008
Oak Ridge, TN 37831-6054
Tel: +1 865 576 8620
lapsamv@ornl.gov